

Transverse Particle Dynamics*

Prof. Steven M. Lund

Physics and Astronomy Department
Facility for Rare Isotope Beams (FRIB)
Michigan State University (MSU)

US Particle Accelerator School (USPAS) Lectures on
“Beam Physics with Intense Space-Charge”
Steven M. Lund and John J. Barnard

US Particle Accelerator School Winter Session
Old Dominion University, 19-30 January, 2015
(Version 20161028)

* Research supported by:

FRIB/MSU, 2014 onward via: U.S. Department of Energy Office of Science Cooperative Agreement DE-SC0000661 and National Science Foundation Grant No. PHY-1102511

and

LLNL/LBNL, before 2014 via: US Dept. of Energy Contract Nos. DE-AC52-07NA27344 and DE-AC02-05CH11231

Transverse Particle Dynamics: Outline

- 1) Particle Equations of Motion
 - 2) Transverse Particle Equations of Motion in Linear Applied Focusing Channels
 - 3) Description of Applied Focusing Fields
 - 4) Transverse Particle Equations of Motion with Nonlinear Applied Fields
 - 5) Transverse Particle Equations of Motion Without Space-Charge, Acceleration and Momentum Spread
 - 6) Floquet's Theorem and the Phase-Amplitude Form of Particle Orbits
 - 7) The Courant-Snyder Invariant and the Single-Particle Emittance
 - 8) The Betatron Formulation of the Particle Orbit
 - 9) Momentum Spread Effects
 - 10) Acceleration and Normalized Emittance
 - 11) Calculation of Acceleration Induced Changes in gamma and beta
 - 12) Symplectic Formulation of Dynamics
 - 13) Self-Consistent Models and Liouville's Theorem
- References

Transverse Particle Dynamics: Detailed Outline

1) Particle Equations of Motion

- A. Introduction: The Lorentz Force Equation
- B. Applied Fields
- C. Machine Lattice
- D. Self Fields
- E. Equation of Motion in s and the Paraxial Approximation
- F. Axial Particle Kinetic Energy
- G. Summary: Transverse Particle Equations of Motion
- H. Overview of Analysis to Come
- I. Bent Coordinate System and Particle Equations of Motion with Dipole Bends and Axial Momentum Spread

Appendix A: Gamma and Beta Factor Conversions

Appendix B: Magnetic Self-Fields

Detailed Outline - 2

2) Transverse Particle Equations of Motion in Linear Focusing Channels

A. Introduction

B. Continuous Focusing

C. Alternating Gradient Quadrupole Focusing – Electric Quadrupoles

D. Alternating Gradient Quadrupole Focusing – Magnetic Quadrupoles

E. Solenoidal Focusing

F. Summary of Transverse Particle Equations of Motion

G. Conservation of Angular Momentum in Axisymmetric Focusing Systems

Appendix A: Quadrupole Skew Coupling

Appendix B: The Larmor Transform to Express Solenoidal Focused Particle Equations of Motion in Uncoupled Form

Appendix C: Transfer Matrices for Solenoidal Focusing

Appendix D: Axisymmetric Magnetic Field Expansion

Appendix E: Thin Lens Equivalence for Thick Lenses

Detailed Outline - 3

3) Description of Applied Focusing Fields

- A. Overview
- B. Magnetic Field Expansions for Focusing and Bending
- C. Hard Edge Equivalent Models
- D. 2D Transverse Multipole Magnetic Moments
- E. Good Field Radius
- F. Example Permanent Magnet Assemblies

4) Transverse Particle Equations of Motion with Nonlinear Applied Fields

- A. Overview
- B. Approach 1: Explicit 3D Form
- C. Approach 2: Perturbed Form

5) Linear Equations of Motion Without Space-Charge, Acceleration, and Momentum Spread

- A. Hill's equation
- B. Transfer Matrix Form of the Solution to Hill's Equation
- C. Wronskian Symmetry of Hill's Equation
- D. Stability of Solutions to Hill's Equation in a Periodic Lattice

Detailed Outline - 4

6) Hill's Equation: Floquet's Theorem and the Phase-Amplitude Form of the Particle Orbit

- A. Introduction
- B. Floquet's Theorem
- C. Phase-Amplitude Form of the Particle Orbit
- D. Summary: Phase-Amplitude Form of the Solution to Hill's Equation
- E. Points on the Phase-Amplitude Formulation
- F. Relation Between the Principal Orbit Functions and the Phase-Amplitude Form Orbit Functions
- G. Undepressed Particle Phase Advance

Appendix A: Calculation of $w(s)$ from Principal Orbit Functions

7) Hill's Equation: The Courant-Snyder Invariant and the Single-Particle Emittance

- A. Introduction
- B. Derivation of the Courant Snyder Invariant
- C. Lattice Maps

Detailed Outline - 5

8) Hill's Equation: The Betatron Formulation of the Particle Orbit and Maximum Orbit Excursions

- A. Formulation
- B. Maximum Orbit Excursions

9) Momentum Spread Effects in Bending and Focusing

- A. Overview
- B. Dispersive Effects
- C. Chromatic Effects

Appendix A: Green Function Solution to the Perturbed Hill's Equation

Appendix B: Uniqueness of the Dispersion Function in a Periodic (Ring) Lattice

Appendix C: Transfer Matrix for a Negative Bend

10) Acceleration and Normalized Emittance

- A. Introduction
- B. Transformation to Normal Form
- C. Phase-Space Relations between Transformed and Untransformed Systems

Detailed Outline - 6

11) Calculation of Acceleration Induced Changes in gamma and beta

- A. Introduction
- B. Solution of the Longitudinal Equations of Motion
- C. Longitudinal Solution via Energy Gain
- D. Quasistatic Potential Expansion

12) Symplectic Formulation of Dynamics

- A. Expression of Hamiltonian Dynamics
- B. Symplectic Dynamics = Phase-Space Area Conservation

13) Self-Consistent Models and Liouville's Theorem

- A. Kilmontovich Equation for Beam/Plasma Evolution
- B. Valasov's Equation and Liouville's Theorem

Contact Information

References

Acknowledgments

S1: Particle Equations of Motion

S1A: Introduction: The Lorentz Force Equation

The *Lorentz force equation* of a charged particle is given by (MKS Units):

$$\frac{d}{dt} \mathbf{p}_i(t) = q_i [\mathbf{E}(\mathbf{x}_i, t) + \mathbf{v}_i(t) \times \mathbf{B}(\mathbf{x}_i, t)]$$

m_i, q_i particle mass, charge $i =$ particle index

$\mathbf{x}_i(t)$ particle coordinate $t =$ time

$\mathbf{p}_i(t) = m_i \gamma_i(t) \mathbf{v}_i(t)$ particle momentum

$\mathbf{v}_i(t) = \frac{d}{dt} \mathbf{x}_i(t) = c \vec{\beta}_i(t)$ particle velocity

$\gamma_i(t) = \frac{1}{\sqrt{1 - \beta_i^2(t)}}$ particle gamma factor

	<u>Total</u>	=	<u>Applied</u>	+	<u>Self</u>
Electric Field:	$\mathbf{E}(\mathbf{x}, t)$		$\mathbf{E}^a(\mathbf{x}, t)$		$\mathbf{E}^s(\mathbf{x}, t)$
Magnetic Field:	$\mathbf{B}(\mathbf{x}, t)$		$\mathbf{B}^a(\mathbf{x}, t)$		$\mathbf{B}^s(\mathbf{x}, t)$

S1B: Applied Fields used to Focus, Bend, and Accelerate Beam

Transverse optics for focusing:

Electric Quadrupole

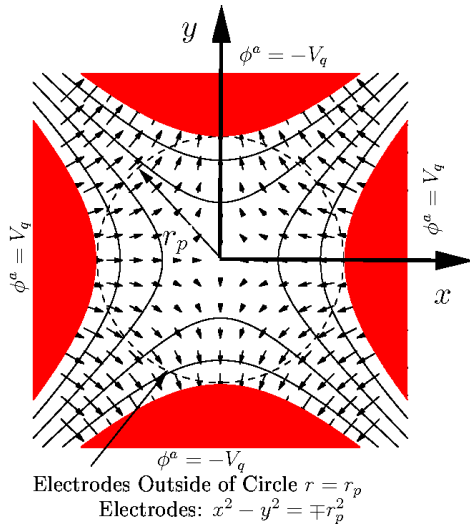

Magnetic Quadrupole

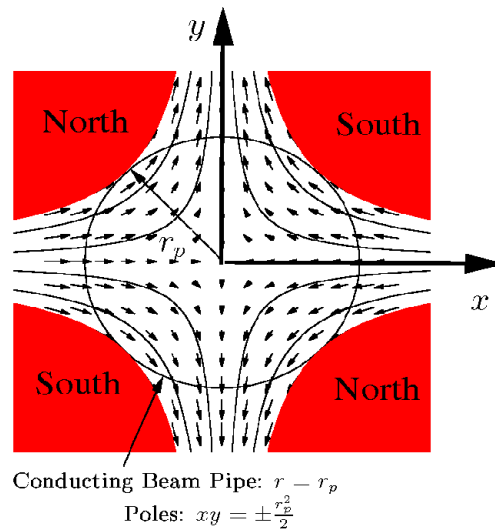

Solenoid

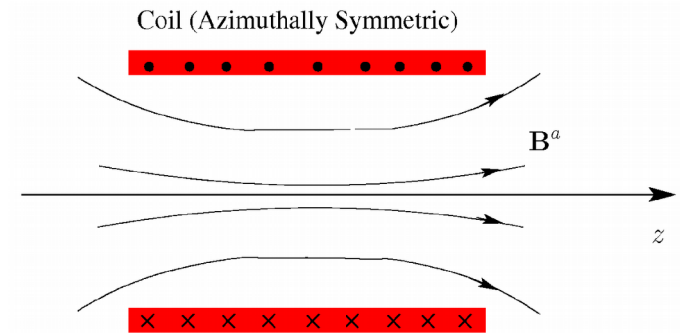

Dipole Bends:

Electric x-direction bend

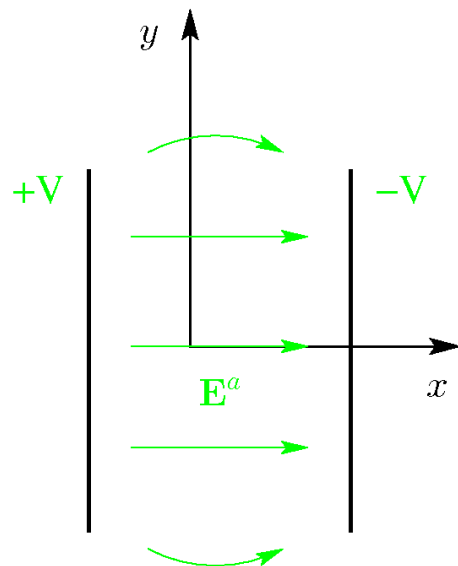

Magnetic x-direction bend

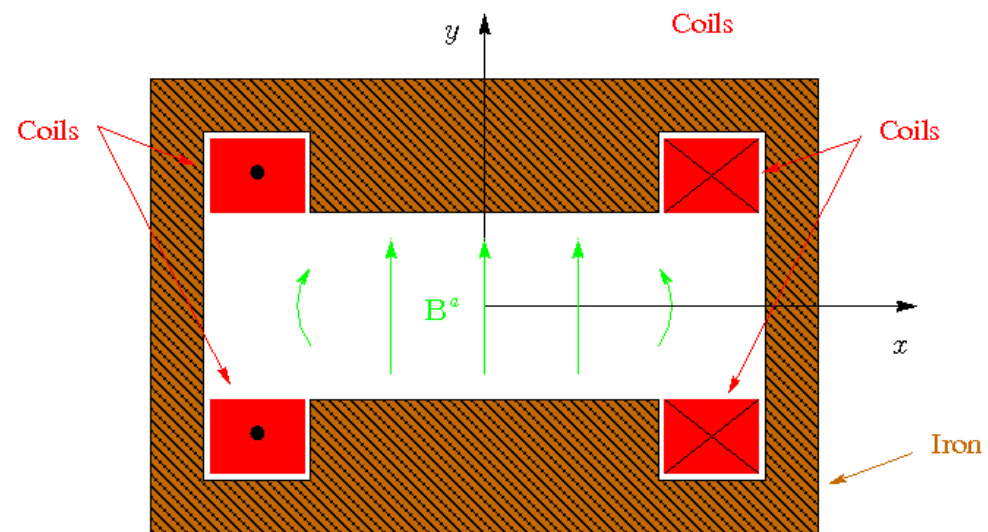

Longitudinal Acceleration:

RF Cavity

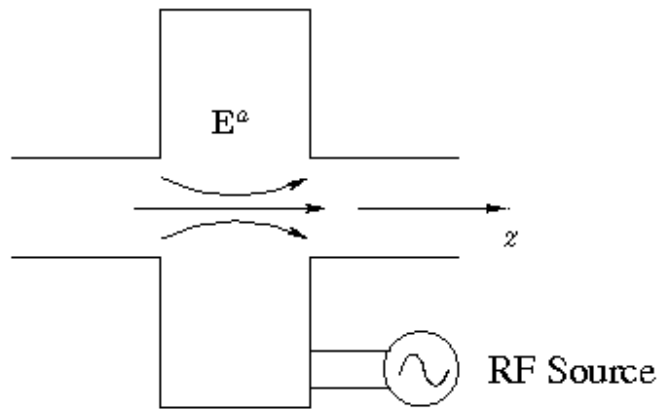

Induction Cell

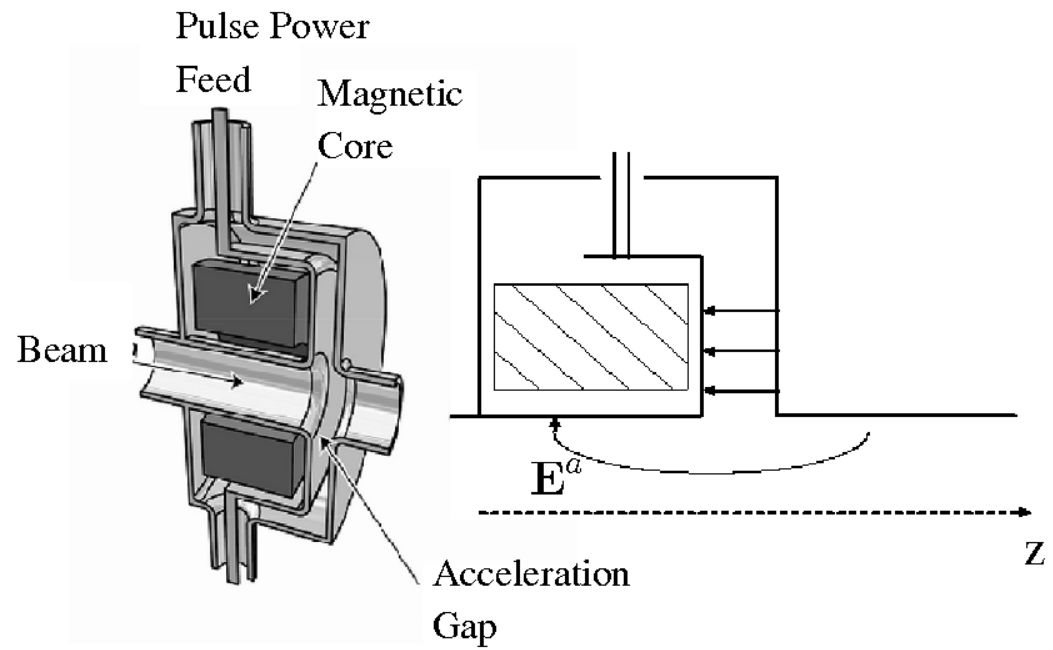

We will cover primarily transverse dynamics. Lectures by J.J. Barnard will cover acceleration and longitudinal physics:

- ◆ Acceleration influences transverse dynamics – not possible to fully decouple

S1C: Machine Lattice

Applied field structures are often arranged in a regular (periodic) lattice for beam transport/acceleration:

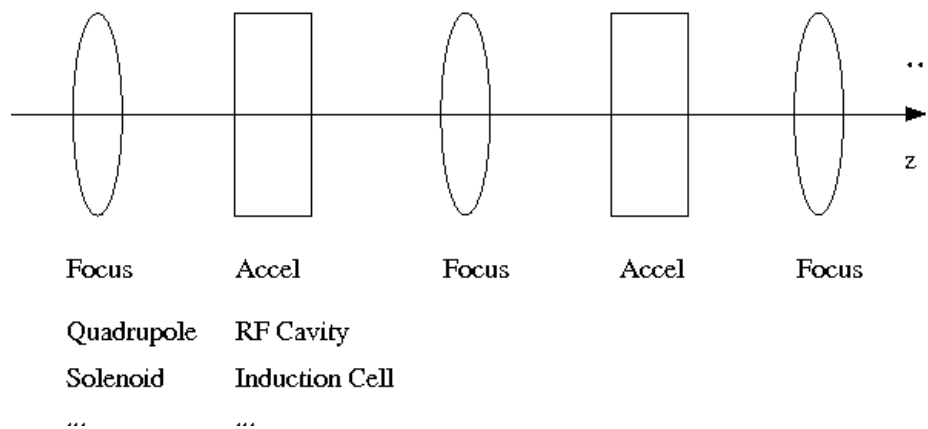

- ▶ Sometimes functions like bending/focusing are combined into a single element

Example – Linear FODO lattice (symmetric quadrupole doublet)

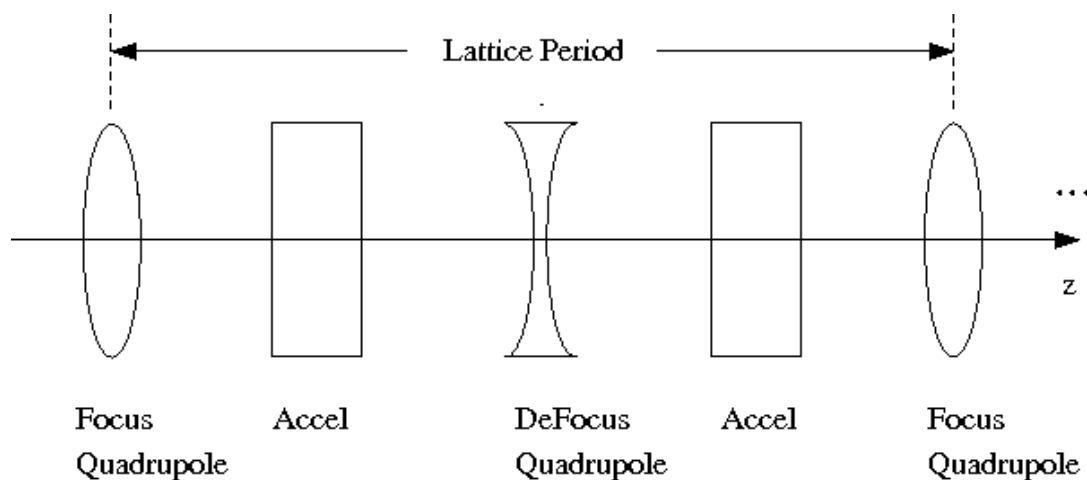

Lattices for rings and some beam insertion/extraction sections also incorporate bends and more complicated periodic structures:

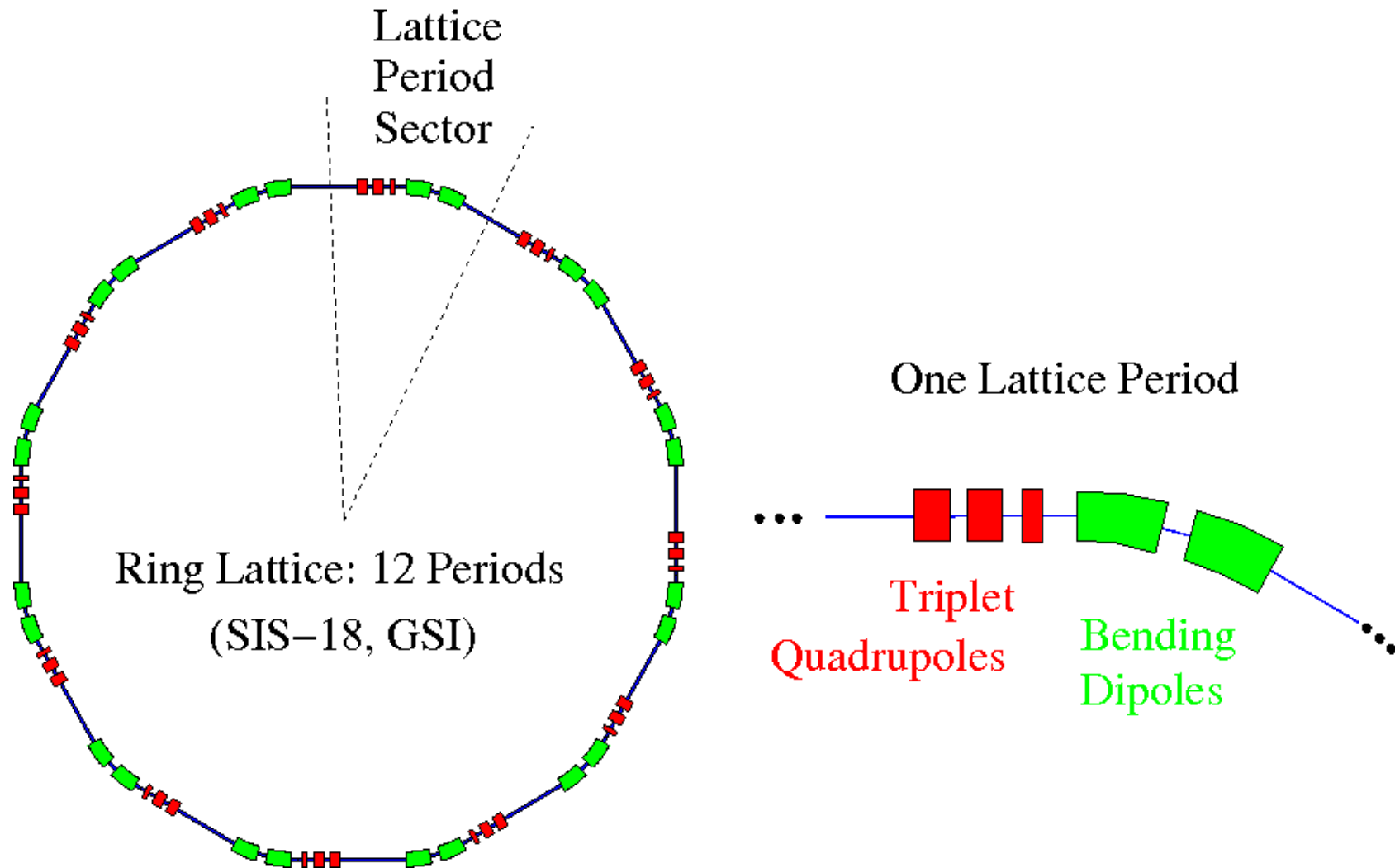

- ◆ Elements to insert beam into and out of ring further complicate lattice
- ◆ Acceleration cells also present
(typically several RF cavities at one or more location)

S1D: Self fields

Self-fields are generated by the distribution of beam particles:

Charges

Currents

Particle at Rest

(pure electrostatic)

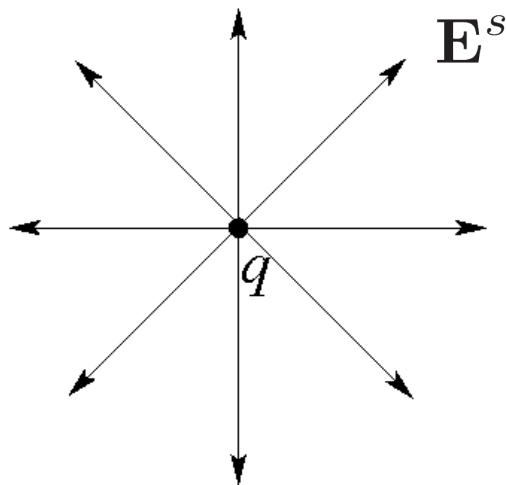

$$\mathbf{B}^s = 0$$

- ◆ Superimpose for all particles in the beam distribution
- ◆ Accelerating particles also radiate
 - We neglect electromagnetic radiation in this class (see: J.J. Barnard, [Intro Lectures](#))

Particle in Motion

Obtain from
Lorentz boost
of rest-frame field:
see Jackson,
*Classical
Electrodynamics*

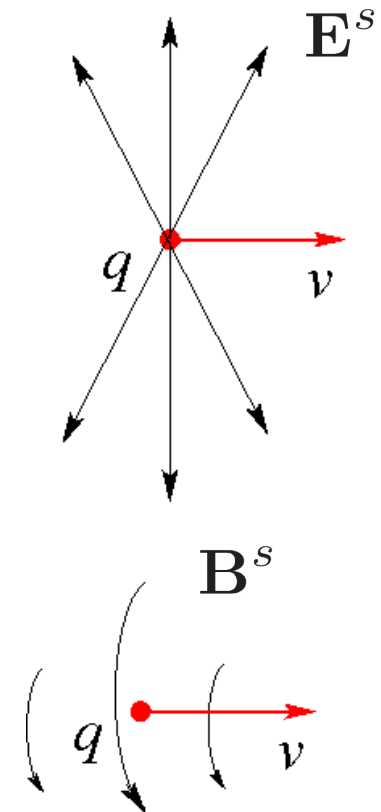

The electric (\mathbf{E}^a) and magnetic (\mathbf{B}^a) fields satisfy the **Maxwell Equations**. The linear structure of the Maxwell equations can be exploited to resolve the field into **Applied** and **Self-Field** components:

$$\mathbf{E} = \mathbf{E}^a + \mathbf{E}^s$$

$$\mathbf{B} = \mathbf{B}^a + \mathbf{B}^s$$

Applied Fields (often quasi-static $\partial/\partial t \simeq 0$) $\mathbf{E}^a, \mathbf{B}^a$

Generated by elements in lattice

$$\begin{aligned} \nabla \cdot \mathbf{E}^a &= \frac{\rho^a}{\epsilon_0} & \nabla \times \mathbf{B}^a &= \mu_0 \mathbf{J}^a + \frac{1}{c^2} \frac{\partial}{\partial t} \mathbf{E}^a \\ \nabla \times \mathbf{E}^a &= -\frac{\partial}{\partial t} \mathbf{B}^a & \nabla \cdot \mathbf{B}^a &= 0 \end{aligned}$$

$$\begin{aligned} \rho^a &= \text{applied charge density} & \frac{1}{\mu_0 \epsilon_0} &= c^2 \\ \mathbf{J}^a &= \text{applied current density} \end{aligned}$$

+ Boundary Conditions on \mathbf{E}^a and \mathbf{B}^a

- ◆ Boundary conditions depend on the total fields \mathbf{E}, \mathbf{B} and if separated into Applied and Self-Field components, care can be required
- ◆ System often solved as static boundary value problem and source free in the vacuum transport region of the beam

/// Aside: Notation:

$$\nabla \equiv \hat{\mathbf{x}} \frac{\partial}{\partial x} + \hat{\mathbf{y}} \frac{\partial}{\partial y} + \hat{\mathbf{z}} \frac{\partial}{\partial z}$$

$$= \hat{\mathbf{r}} \frac{\partial}{\partial r} + \frac{\hat{\theta}}{r} \frac{\partial}{\partial \theta} + \hat{\mathbf{z}} \frac{\partial}{\partial z}$$

$$= \frac{\partial}{\partial \mathbf{x}}$$

$$= \frac{\partial}{\partial \mathbf{x}_{\perp}} + \hat{\mathbf{z}} \frac{\partial}{\partial z}$$

$$\mathbf{x} = \hat{\mathbf{x}}x + \hat{\mathbf{y}}y + \hat{\mathbf{z}}z$$

$$= \mathbf{x}_{\perp} + \hat{\mathbf{z}}z$$

$$\mathbf{x}_{\perp} \equiv \hat{\mathbf{x}}x + \hat{\mathbf{y}}y$$

In integrals, we denote:

$$\int d^3x \cdots = \int_{-\infty}^{\infty} dx \int_{-\infty}^{\infty} dy \int_{-\infty}^{\infty} dz \cdots = \int d^2x_{\perp} \int_{-\infty}^{\infty} dz \cdots$$

$$\int d^2x_{\perp} \cdots = \int_{-\infty}^{\infty} dx \int_{-\infty}^{\infty} dy \cdots = \int_0^{\infty} dr r \int_{-\pi}^{\pi} d\theta \cdots$$

- Cartesian Representation

- Cylindrical Representation

$$x = r \cos \theta$$

$$\hat{\mathbf{r}} = \hat{\mathbf{x}} \cos \theta + \hat{\mathbf{y}} \sin \theta$$

$$y = r \sin \theta$$

$$\hat{\theta} = -\hat{\mathbf{x}} \sin \theta + \hat{\mathbf{y}} \cos \theta$$

- Abbreviated Representation

- Resolved Abbreviated Representation

Resolved into Perpendicular (\perp)
and Parallel (z) components

Self-Fields (dynamic, evolve with beam)

Generated by particle of the beam rather than (applied) sources outside beam

$$\nabla \cdot \mathbf{E}^s = \frac{\rho^s}{\epsilon_0} \qquad \nabla \times \mathbf{B}^s = \mu_0 \mathbf{J}^s + \frac{1}{c^2} \frac{\partial}{\partial t} \mathbf{E}^s$$

$$\nabla \times \mathbf{E}^s = -\frac{\partial}{\partial t} \mathbf{B}^s \qquad \nabla \cdot \mathbf{B}^s = 0$$

ρ^s = beam charge density

$$= \sum_{i=1}^N q_i \delta[\mathbf{x} - \mathbf{x}_i(t)]$$

\mathbf{J}^s = beam current density

$$= \sum_{i=1}^N q_i \mathbf{v}_i(t) \delta[\mathbf{x} - \mathbf{x}_i(t)]$$

i = particle index
(N particles)

q_i = particle charge

\mathbf{x}_i = particle coordinate

\mathbf{v}_i = particle velocity

$$\delta(\mathbf{x}) \equiv \delta(x)\delta(y)\delta(z)$$

$\delta(x)$ \equiv Dirac-delta function

$$\sum_{i=1}^N \dots = \text{sum over beam particles}$$

+ Boundary Conditions on \mathbf{E}^s and \mathbf{B}^s
from material structures, radiation conditions, etc.

In accelerators, typically there is ideally a **single species of particle**:

$$\begin{aligned} q_i &\rightarrow q \\ m_i &\rightarrow m \end{aligned}$$

Large Simplification!

Multi-species results in more complex collective effects

Motion of particles within axial slices of the “bunch” are **highly directed**:

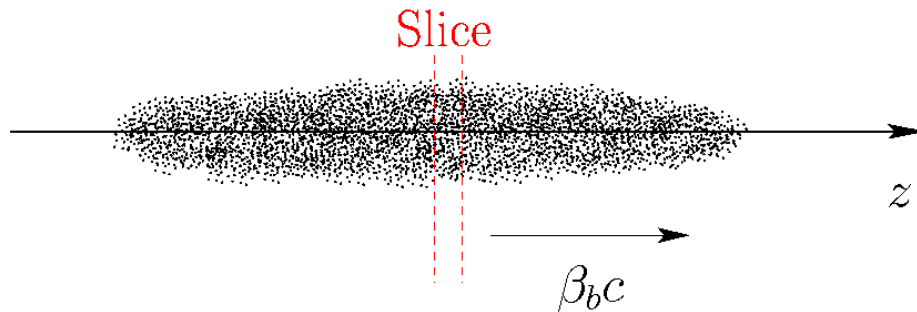

$$\begin{aligned} \beta_b(z)c &\equiv \frac{1}{N'} \sum_{i=1}^{N'} \mathbf{v}_i \cdot \hat{\mathbf{z}} \\ &= \text{Mean axial velocity of} \\ &\quad N' \text{ particles in beam slice} \end{aligned}$$

$$\frac{d}{dt} \mathbf{x}_i(t) = \mathbf{v}_i(t) = \hat{\mathbf{z}} \beta_b(z)c + \delta \mathbf{v}_i$$

$$|\delta \mathbf{v}_i| \ll |\beta_b|c \quad \text{Paraxial Approximation}$$

There are typically **many particles**: (see **S13**, Vlasov Models for more details)

$$\begin{aligned} \rho^s &= \sum_{i=1}^N q_i \delta[\mathbf{x} - \mathbf{x}_i(t)] & \mathbf{J}^s &= \sum_{i=1}^N q_i \mathbf{v}_i(t) \delta[\mathbf{x} - \mathbf{x}_i(t)] \\ &\simeq \rho(\mathbf{x}, t) \text{ continuous} & & \simeq \beta_b c \rho(\mathbf{x}, t) \hat{\mathbf{z}} \text{ continuous axial} \\ &\text{charge-density} & & \text{current-density} \end{aligned}$$

The beam evolution is typically **sufficiently slow** (for heavy ions) where we can **neglect radiation** and approximate the self-field Maxwell Equations as:

See: **Appendix B, Magnetic Self-Fields** and

J. J. Barnard, **Intro. Lectures: Electrostatic Approximation**

$$\mathbf{E}^s = -\nabla\phi$$

$$\mathbf{B}^s = \nabla \times \mathbf{A} \quad \mathbf{A} = \hat{\mathbf{z}} \frac{\beta_b}{c} \phi$$

$$\nabla^2 \phi = \frac{\partial}{\partial \mathbf{x}} \cdot \frac{\partial}{\partial \mathbf{x}} \phi = -\frac{\rho^s}{\epsilon_0}$$

+ Boundary Conditions on ϕ

Vast Reduction of self-field model:

Approximation equiv to electrostatic interactions in frame moving with beam: see **Appendix B**

But still complicated

Resolve the **Lorentz force** acting on beam particles into **Applied** and **Self-Field** terms:

$$\mathbf{F}_i(\mathbf{x}_i, t) = q\mathbf{E}(\mathbf{x}_i, t) + q\mathbf{v}_i(t) \times \mathbf{B}(\mathbf{x}_i, t)$$

$$\mathbf{F}_i = \mathbf{F}_i^a + \mathbf{F}_i^s$$

$$\mathbf{E} = \mathbf{E}^a + \mathbf{E}^s$$

$$\mathbf{B} = \mathbf{B}^a + \mathbf{B}^s$$

Applied:

$$\mathbf{F}_i^a = q\mathbf{E}_i^a + q\mathbf{v}_i \times \mathbf{B}_i^a$$

Self-Field:

$$\mathbf{F}_i^s = q\mathbf{E}_i^s + q\mathbf{v}_i \times \mathbf{B}_i^s$$

$$\mathbf{E}^a(\mathbf{x}_i, t) \equiv \mathbf{E}_i^a \text{ etc.}$$

The self-field force can be simplified:

♦ See also: J.J. Barnard, [Intro. Lectures](#)

Plug in self-field forms:

$$\mathbf{F}_i^s = q\mathbf{E}_i^s + q\mathbf{v}_i \times \mathbf{B}_i^s \quad \dots \Big|_i \equiv \dots \Big|_{\mathbf{x}=\mathbf{x}_i}$$

$$\simeq q \left[-\frac{\partial\phi}{\partial\mathbf{x}} \Big|_i + (\beta_b c \hat{\mathbf{z}} + \delta\mathbf{v}_i) \times \left(\frac{\partial}{\partial\mathbf{x}} \times \hat{\mathbf{z}} \frac{\beta_b}{c} \phi \right) \Big|_i \right]$$

~0 Neglect: Paraxial

Resolve into transverse (x and y) and longitudinal (z) components and simplify:

$$\begin{aligned} \beta_b c \hat{\mathbf{z}} \times \left(\frac{\partial}{\partial\mathbf{x}} \times \hat{\mathbf{z}} \frac{\beta_b}{c} \phi \right) \Big|_i &= \beta_b^2 \hat{\mathbf{z}} \times \left(\frac{\partial}{\partial\mathbf{x}_\perp} \times \hat{\mathbf{z}} \phi \right) \Big|_i \\ &= \beta_b^2 \hat{\mathbf{z}} \times \left(\frac{\partial\phi}{\partial y} \hat{\mathbf{x}} - \frac{\partial\phi}{\partial x} \hat{\mathbf{y}} \right) \Big|_i \\ &= \beta_b^2 \left(\frac{\partial\phi}{\partial x} \hat{\mathbf{x}} + \frac{\partial\phi}{\partial y} \hat{\mathbf{y}} \right) \Big|_i \\ &= \beta_b^2 \frac{\partial\phi}{\partial\mathbf{x}_\perp} \Big|_i \end{aligned}$$

also

$$-\left. \frac{\partial \phi}{\partial \mathbf{x}} \right|_i = -\left. \frac{\partial \phi}{\partial \mathbf{x}_\perp} \right|_i - \left. \frac{\partial \phi}{\partial z} \right|_i \hat{\mathbf{z}}$$

Together, these results give:

$$\mathbf{F}_i^s = \left[-\frac{q}{\gamma_b^2} \left. \frac{\partial \phi}{\partial \mathbf{x}_\perp} \right|_i \right] \left[-\hat{\mathbf{z}} q \left. \frac{\partial \phi}{\partial z} \right|_i \right]$$

Transverse

Longitudinal

$$\gamma_b \equiv \frac{1}{\sqrt{1 - \beta_b^2}}$$

Axial relativistic gamma of beam

- Transverse and longitudinal forces have different axial gamma factors
- $1/\gamma_b^2$ factor in transverse force shows the space-charge forces become weaker as axial beam kinetic energy increases
 - Most important in low energy (nonrelativistic) beam transport
 - Strong in/near injectors before much acceleration

/// Aside: Singular Self Fields

In *free space*, the beam potential generated from the singular charge density:

$$\rho^s = \sum_{i=1}^N q_i \delta[\mathbf{x} - \mathbf{x}_i(t)]$$

is

$$\phi(\mathbf{x}) = \frac{q}{4\pi\epsilon_0} \sum_{i=1}^N \frac{1}{|\mathbf{x} - \mathbf{x}_i|}$$

Thus, the force of a particle at $\mathbf{x} = \mathbf{x}_i$ is:

$$\mathbf{F}_i = -q \left. \frac{\partial \phi}{\partial \mathbf{x}} \right|_i = \frac{q^2}{4\pi\epsilon_0} \sum_{j=1}^N \frac{(\mathbf{x}_i - \mathbf{x}_j)}{|\mathbf{x}_i - \mathbf{x}_j|^{3/2}}$$

Which diverges due to the $i = j$ term. This divergence is essentially “erased” when the continuous charge density is applied:

$$\rho^s = \sum_{i=1}^N q_i \delta[\mathbf{x} - \mathbf{x}_i(t)] \longrightarrow \rho(\mathbf{x}, t)$$

- ◆ Effectively removes effect of collisions

See: J.J. Barnard, **Intro Lectures** for more details

- Find collisionless Vlasov model of evolution is often adequate

///

The particle equations of motion in $\mathbf{x}_i - \mathbf{v}_i$ phase-space variables become:

◆ Separate parts of $q\mathbf{E}_i^a + q\mathbf{v}_i \times \mathbf{B}_i^a$ into transverse and longitudinal comp
Transverse

$$\frac{d}{dt}\mathbf{x}_{\perp i} = \mathbf{v}_{\perp i}$$

$$\frac{d}{dt}(m\gamma_i\mathbf{v}_{\perp i}) \simeq \underbrace{q\mathbf{E}_{\perp i}^a + q\beta_b c\hat{\mathbf{z}} \times \mathbf{B}_{\perp i}^a + qB_{zi}^a\mathbf{v}_{\perp i} \times \hat{\mathbf{z}}}_{\text{Applied}} - q \underbrace{\frac{1}{\gamma_b^2} \frac{\partial\phi}{\partial\mathbf{x}_{\perp}} \Big|_i}_{\text{Self}}$$

Longitudinal

$$\frac{d}{dt}z_i = v_{zi}$$

$$\frac{d}{dt}(m\gamma_i v_{zi}) \simeq \underbrace{qE_{zi}^a - q(v_{xi}B_{yi}^a - v_{yi}B_{xi}^a)}_{\text{Applied}} - q \underbrace{\frac{\partial\phi}{\partial z} \Big|_i}_{\text{Self}}$$

In the remainder of this (and most other) lectures, we analyze **Transverse Dynamics**. **Longitudinal Dynamics** will be covered in J.J. Barnard lectures

- ◆ Except near injector, acceleration is typically slow
 - Fractional change in γ_b, β_b small over characteristic transverse dynamical scales such as lattice period and betatron oscillation periods
- ◆ Regard γ_b, β_b as specified functions given by the “**acceleration schedule**”

S1E: Equations of Motion in s and the Paraxial Approximation

In transverse accelerator dynamics, it is convenient to employ the axial coordinate (s) of a particle in the accelerator as the **independent** variable:

- Need fields at lattice location of particle to integrate equations for particle trajectories

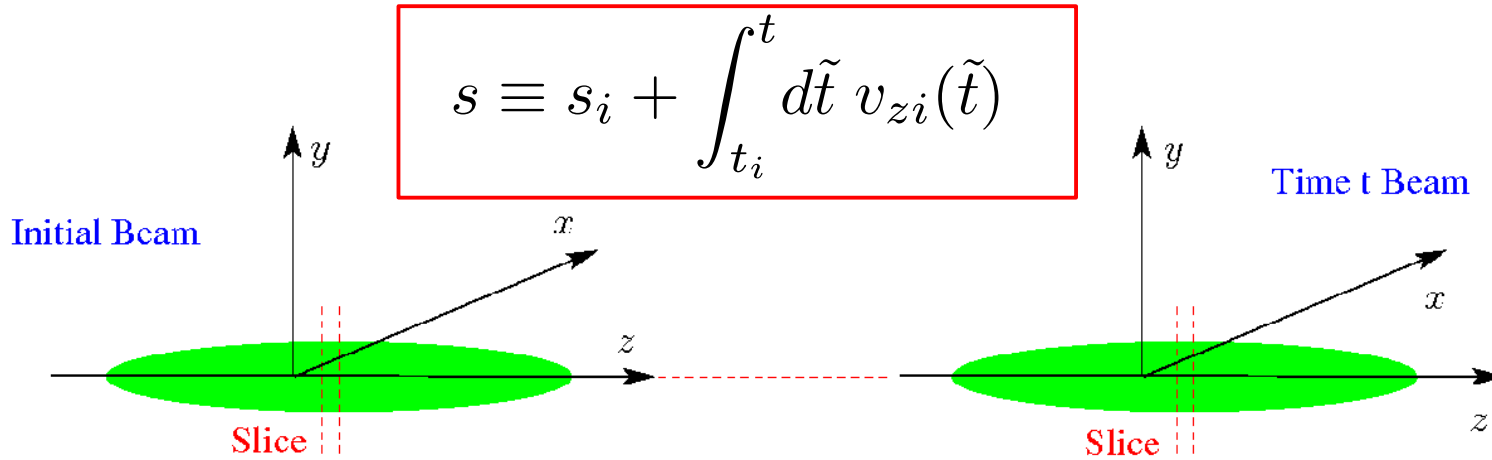

Transform:

$$\begin{aligned} t &= t_i \\ s &= s_i \end{aligned}$$

$$\begin{aligned} t & \\ s & \end{aligned}$$

$$v_{zi} = \frac{ds}{dt} \implies v_{xi} = \frac{dx_i}{dt} = \frac{ds}{dt} \frac{dx_i}{ds} = v_{zi} \frac{dx_i}{ds} = (\beta_b c + \delta v_{zi}) \frac{dx_i}{ds}$$

Neglect

$$\simeq \beta_b c \frac{dx_i}{ds}$$

Denote:

$$' \equiv \frac{d}{ds}$$

$$v_{xi} = \frac{dx_i}{dt} \simeq \beta_b c x'_i$$

$$v_{yi} = \frac{dy_i}{dt} \simeq \beta_b c y'_i$$

Neglecting term consistent with assumption of small longitudinal momentum spread (paraxial approximation)

- Procedure becomes more complicated when bends present: see **S1H**

In the **paraxial approximation**, x' and y' can be interpreted as the (small magnitude) angles that the particles make with the longitudinal-axis:

$$x - \text{angle} = \frac{v_{xi}}{v_{zi}} \simeq \frac{v_{xi}}{\beta_b c} = x'_i$$

$$y - \text{angle} = \frac{v_{yi}}{v_{zi}} \simeq \frac{v_{yi}}{\beta_b c} = y'_i$$

Typical accel lattice values:
 $|x'| < 50 \text{ mrad}$

The angles will be *small* in the paraxial approximation:

$$v_{xi}^2, v_{yi}^2 \ll \beta_b^2 c^2 \implies x_i'^2, y_i'^2 \ll 1$$

Since the spread of axial momentum/velocities is small in the paraxial approximation, a thin axial slice of the beam maps to a thin axial slice and s can also be thought of as the axial coordinate of the slice in the accelerator lattice

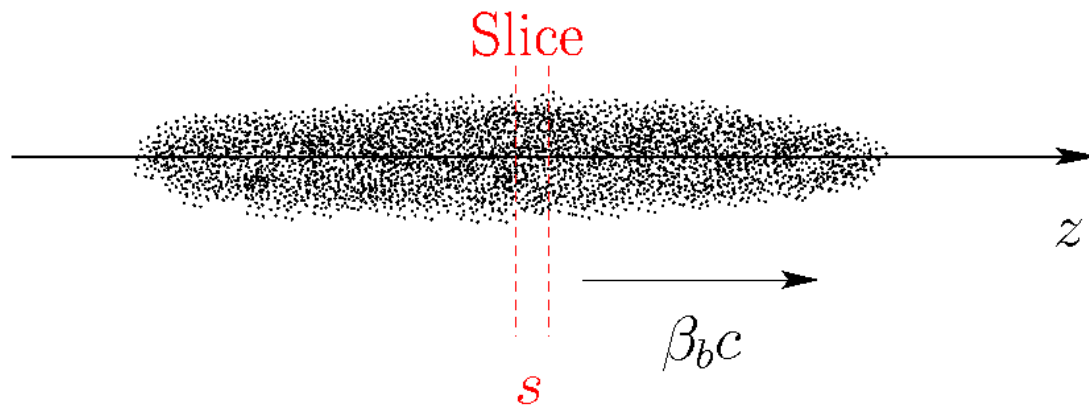

$$\beta_b \equiv \sum_{i=1}^{N'} \frac{v_{zi}}{c}$$

slice

$$s \simeq s_i + \int_{t_i}^t d\tilde{t} \beta_b(\tilde{t})$$

$$s \simeq s_i + \int_{t_i}^t d\tilde{t} \beta_b(\tilde{t})$$

The coordinate s can alternatively be interpreted as the axial coordinate of a reference (design) particle moving in the lattice

- ◆ Design particle has no momentum spread

It is often desirable to express the particle equations of motion in terms of s rather than the time t

- ◆ Makes it clear where you are in the lattice of the machine
- ◆ Sometimes easier to use t in codes when including many effects to high order

Transform transverse particle equations of motion to s rather than t derivatives

$$\boxed{\frac{d}{dt}(m\gamma_i \mathbf{v}_{\perp i})} \simeq q\mathbf{E}_{\perp i}^a + q\beta_b c \hat{\mathbf{z}} \times \mathbf{B}_{\perp i}^a + \boxed{qB_{zi}^a \mathbf{v}_{\perp i} \times \hat{\mathbf{z}}} - q \frac{1}{\gamma_b^2} \left. \frac{\partial \phi}{\mathbf{x}_{\perp}} \right|_i$$

Term 1

Term 2

Transform **Terms 1** and **2** in the particle equation of motion:

$$\begin{aligned} \text{Term 1: } \frac{d}{dt} \left(m\gamma_i \frac{d\mathbf{x}_{\perp i}}{dt} \right) &= mv_{zi} \frac{d}{ds} \left(\gamma_i v_{zi} \frac{d\mathbf{x}_{\perp i}}{ds} \right) & \frac{d}{dt} &= v_{zi} \frac{d}{ds} \\ &= m\gamma_i v_{zi}^2 \frac{d^2}{ds^2} \mathbf{x}_{\perp i} + mv_{zi} \left(\frac{d}{ds} \mathbf{x}_{\perp i} \right) \frac{d}{ds} (\gamma_i v_{zi}) \\ & \qquad \qquad \qquad \text{Term 1A} & \qquad \qquad \qquad \text{Term 1B} \end{aligned}$$

Approximate:

$$\text{Term 1A: } m\gamma_i v_{zi}^2 \frac{d^2}{ds^2} \mathbf{x}_{\perp i} \simeq m\gamma_b \beta_b^2 c^2 \frac{d^2}{ds^2} \mathbf{x}_{\perp i} = m\gamma_b \beta_b^2 c^2 \mathbf{x}_{\perp i}''$$

$$\begin{aligned} \text{Term 1B: } mv_{zi} \left(\frac{d}{ds} \mathbf{x}_{\perp i} \right) \frac{d}{ds} (\gamma_i v_{zi}) &\simeq m\beta_b c \left(\frac{d}{ds} \mathbf{x}_{\perp i} \right) \frac{d}{ds} (\gamma_b \beta_b c) \\ &\simeq m\beta_b c^2 (\gamma_b \beta_b)' \mathbf{x}_{\perp i}' \end{aligned}$$

Using the approximations **1A** and **1B** gives for **Term 1**:

$$m \frac{d}{dt} \left(\gamma_i \frac{d\mathbf{x}_{\perp i}}{dt} \right) \simeq m \gamma_b \beta_b^2 c^2 \left[\mathbf{x}_{\perp i}'' + \frac{(\gamma_b \beta_b)'}{(\gamma_b \beta_b)} \mathbf{x}_{\perp i}' \right]$$

Similarly we approximate in **Term 2**:

$$q B_{zi}^a \mathbf{v}_{\perp i} \times \hat{\mathbf{z}} \simeq q B_{zi}^a \beta_b c \mathbf{x}_{\perp i}' \times \hat{\mathbf{z}}$$

Using the simplified expressions for **Terms 1** and **2** obtain the reduced transverse equation of motion:

$$\begin{aligned} \mathbf{x}_{\perp i}'' + \frac{(\gamma_b \beta_b)'}{(\gamma_b \beta_b)} \mathbf{x}_{\perp i}' &= \frac{q}{m \gamma_b \beta_b^2 c^2} \mathbf{E}_{\perp i}^a + \frac{q}{m \gamma_b \beta_b c} \hat{\mathbf{z}} \times \mathbf{B}_{\perp i}^a \\ &+ \frac{q B_{zi}^a}{m \gamma_b \beta_b c} \mathbf{x}_{\perp i}' \times \hat{\mathbf{z}} - \frac{q}{m \gamma_b^3 \beta_b^2 c^2} \left. \frac{\partial \phi}{\partial \mathbf{x}_{\perp}} \right|_i \end{aligned}$$

- ◆ Will be analyzed extensively in lectures that follow in various limits to better understand solution properties

S1F: Axial Particle Kinetic Energy

Relativistic particle kinetic energy is:

$$\mathcal{E} = (\gamma - 1)mc^2$$

$$\gamma = \frac{1}{\sqrt{1 - \mathbf{v}^2/c^2}}$$

$$\mathbf{v} = (\beta_b + \delta\beta_z)c\hat{\mathbf{z}} + \beta_{\perp}c\hat{\mathbf{x}}_{\perp}$$

= Particle Velocity (3D)

For a directed **paraxial beam** with motion primarily along the machine axis the kinetic energy is essentially the **axial kinetic energy** \mathcal{E}_b :

$$\mathcal{E} = (\gamma_b - 1)mc^2 + \Theta\left(\frac{|\delta\beta_z|}{\beta_b}, \frac{\beta_{\perp}^2}{\beta_b^2}\right)$$

$$\mathcal{E} \simeq \mathcal{E}_b \equiv (\gamma_b - 1)mc^2$$

In **nonrelativistic limit**: $\beta_b^2 \ll 1$

$$\begin{aligned}\mathcal{E}_b \equiv (\gamma_b - 1)mc^2 &= \frac{1}{2}m\beta_b^2c^2 + \frac{3}{8}m\beta_b^4c^2 + \dots \\ &\simeq \frac{1}{2}m\beta_b^2c^2 + \Theta(\beta_b^4)\end{aligned}$$

Convenient units:

Electrons:

$$m = m_e = 511 \frac{\text{keV}}{c^2}$$

Electrons rapidly relativistic
due to relatively low mass

Ions/Protons:

$$m = (\text{atomic mass}) \cdot m_u$$

$$\begin{aligned} m_u &\equiv \text{Atomic Mass Unit} \\ &= 931.49 \frac{\text{MeV}}{c^2} \end{aligned}$$

Note:

$$m_p = \text{Proton Mass} = 938.27 \frac{\text{MeV}}{c^2}$$

$$m_p \simeq m_n \simeq 940 \frac{\text{MeV}}{c^2}$$

$$m_n = \text{Neutron Mass} = 939.57 \frac{\text{MeV}}{c^2}$$

Approximate roughly for ions:

$$m \simeq Am_u \quad \begin{array}{l} A = \text{Mass Number} \\ \text{(Number of Nucleons)} \end{array}$$

$$m_u \gg m_e$$

Protons/ions take much longer to become relativistic than electrons

$m_p, m_n > m_u$ due to nuclear binding energy

$$\frac{\mathcal{E}_b/A}{m_u c^2} \simeq \gamma_b - 1 \quad \Longrightarrow$$

$$\begin{aligned} \gamma_b &= 1 + \frac{\mathcal{E}_b/A}{m_u c^2} \\ \beta_b &= \sqrt{1 - 1/\gamma_b^2} \end{aligned}$$

Energy/Nucleon \mathcal{E}_b/A fixes β_b to set phase needs of RF cavities

Contrast beam relativistic β_b for electrons and protons/ions:

Electrons

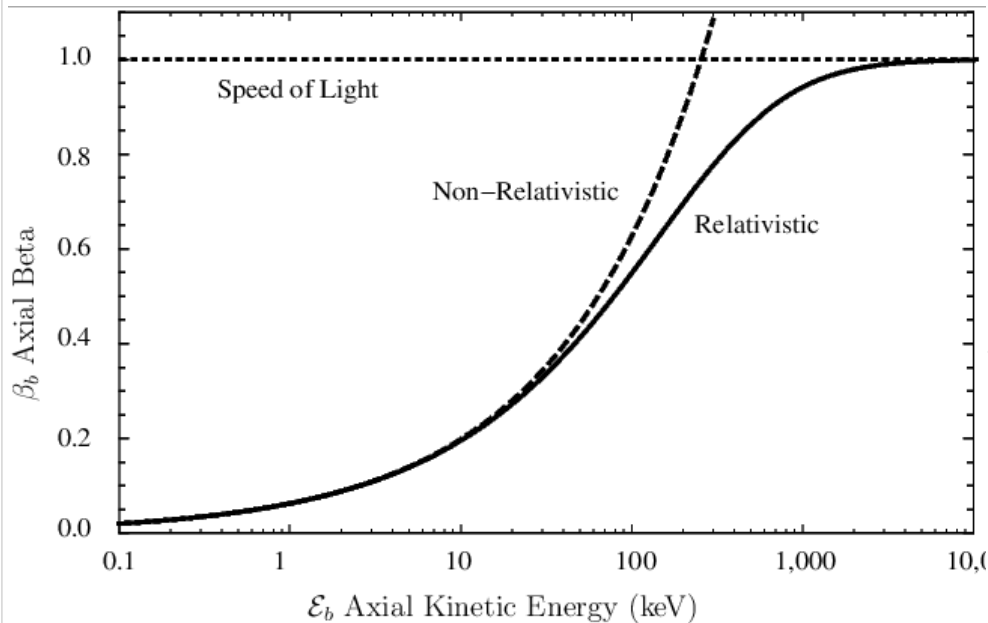

Ions (and approx Protons)

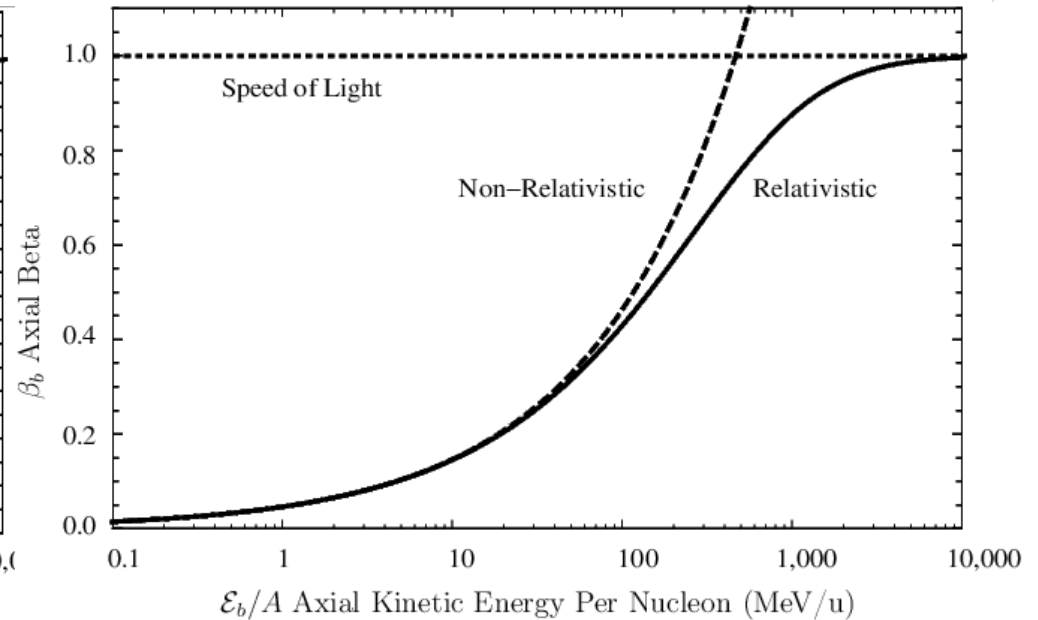

Notes: 1) plots do not overlay, scale changed

2) Ion plot slightly off for protons since $m_u \neq m_p$

- ◆ Electrons become relativistic easier relative to protons/ions due to light mass
- ◆ Space-charge more important for ions than electrons (see **Sec. S1D**)
 - Low energy ions near injector expected to have strongest space-charge

S1G: Summary: Transverse Particle Equations of Motion

$$\mathbf{x}''_{\perp} + \frac{(\gamma_b \beta_b)'}{(\gamma_b \beta_b)} \mathbf{x}'_{\perp} = \frac{q}{m \gamma_b \beta_b^2 c^2} \mathbf{E}_{\perp}^a + \frac{q}{m \gamma_b \beta_b c} \hat{\mathbf{z}} \times \mathbf{B}_{\perp}^a + \frac{q B_z^a}{m \gamma_b \beta_b c} \mathbf{x}'_{\perp} \times \hat{\mathbf{z}} - \frac{q}{m \gamma_b^3 \beta_b^2 c^2} \frac{\partial}{\partial \mathbf{x}_{\perp}} \phi$$

\mathbf{E}^a = Applied Electric Field

\mathbf{B}^a = Applied Magnetic Field

$$' \equiv \frac{d}{ds}$$

$$\gamma_b \equiv \frac{1}{\sqrt{1 - \beta_b^2}}$$

$$\nabla^2 \phi = \frac{\partial}{\partial \mathbf{x}} \cdot \frac{\partial}{\partial \mathbf{x}} \phi = -\frac{\rho}{\epsilon_0}$$

+ Boundary Conditions on ϕ

Drop particle i subscripts (in most cases) henceforth to simplify notation

Neglects axial energy spread, bending, and electromagnetic radiation

γ -factors different in applied and self-field terms:

In $-\frac{q}{m \gamma_b^3 \beta_b^2 c^2} \frac{\partial}{\partial \mathbf{x}} \phi$, contributions to γ_b^3 :

$\gamma_b \implies$ Kinematics

$\gamma_b^2 \implies$ Self-Magnetic Field Corrections (leading order)

S1H: Preview: Analysis to Come

Much of transverse accelerator physics centers on understanding the evolution of beam particles in **4-dimensional** $x-x'$ and $y-y'$ phase space.

Typically, restricted **2-dimensional** phase-space projections in $x-x'$ and/or $y-y'$ are analyzed to simplify interpretations:

When **forces** are **linear** particles tend to move on ellipses of constant area

- Ellipse may elongate/shrink and rotate as beam evolves in lattice

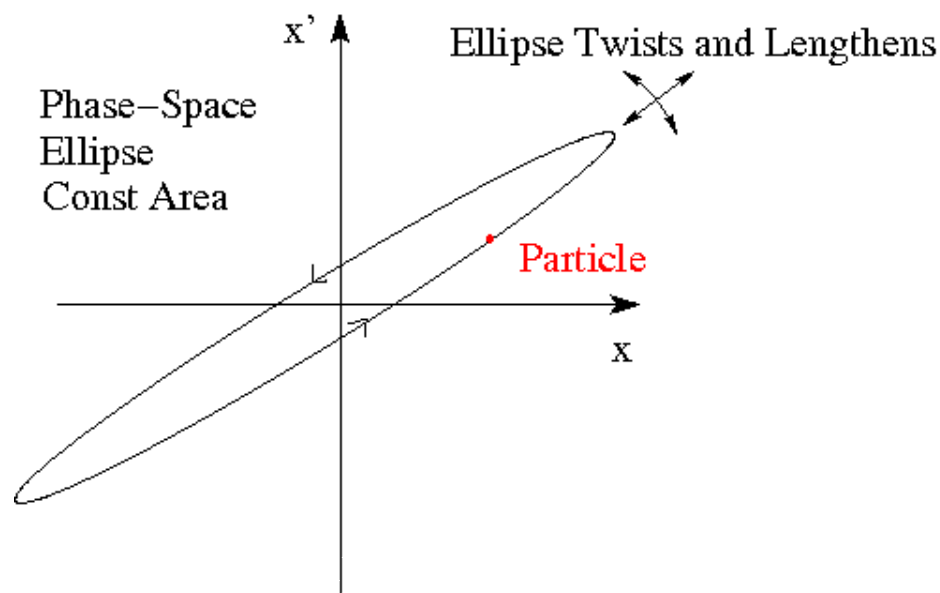

Nonlinear force components distort orbits and cause undesirable effects

- Growth in effective phase-space area reduces focusability

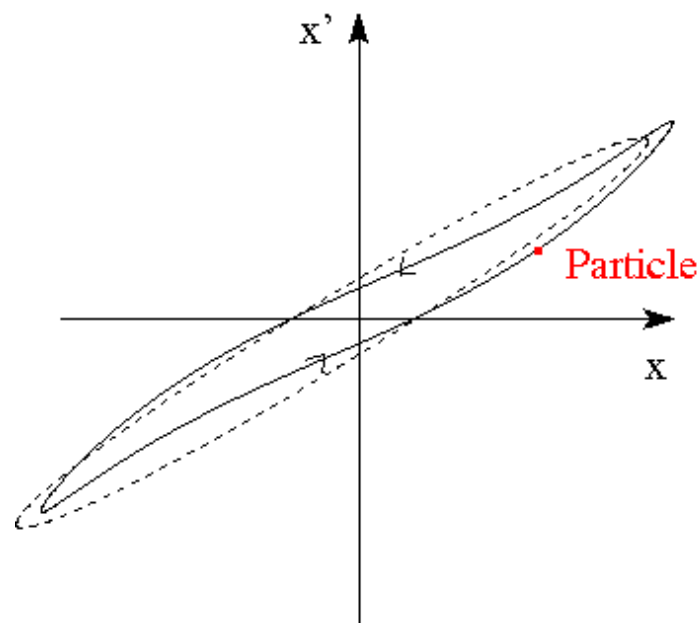

The “effective” phase-space volume of a distribution of beam particles is of fundamental interest

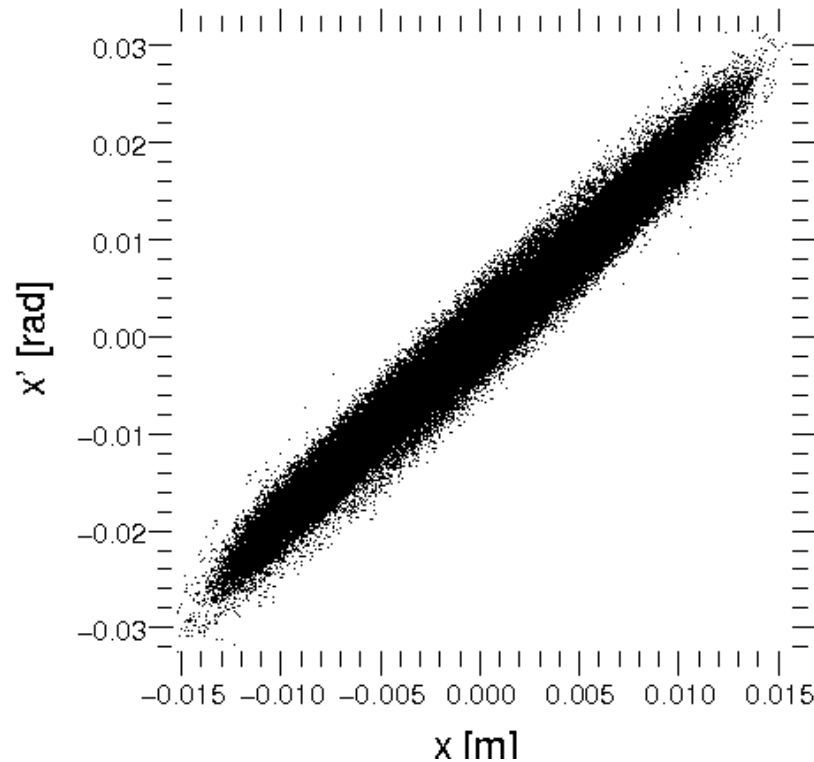

Effective area measure in x - x' phase-space is the x -emittance

Statistical ”Area” $\sim \pi \varepsilon_x$

$$\varepsilon_x = 4[\langle x^2 \rangle_{\perp} \langle x'^2 \rangle_{\perp} - \langle xx' \rangle_{\perp}^2]^{1/2}$$

We will find in statistical beam descriptions that:

Larger/Smaller beam phase-space areas
(**Larger/Smaller** emittances)



Harder/Easier
to focus beam
on small final spots

Much of advanced accelerator physics centers on preserving beam quality by understanding and controlling **emittance growth** due to **nonlinear forces** arising from both space-charge and the applied focusing. In the remainder of the next few lectures we will review the physics of a single particles moving in linear applied fields with emphasis on transverse effects. Later, we will generalize concepts to include forces from space-charge in this formulation and nonlinear effects from both applied and self-fields.

S1I: Bent Coordinate System and Particle Equations of Motion with Dipole Bends and Axial Momentum Spread

The previous equations of motion can be applied to dipole bends provided the x, y, z coordinate system is fixed. It can prove more convenient to employ coordinates that follow the beam in a bend.

- Orthogonal system employed called Frenet-Serret coordinates

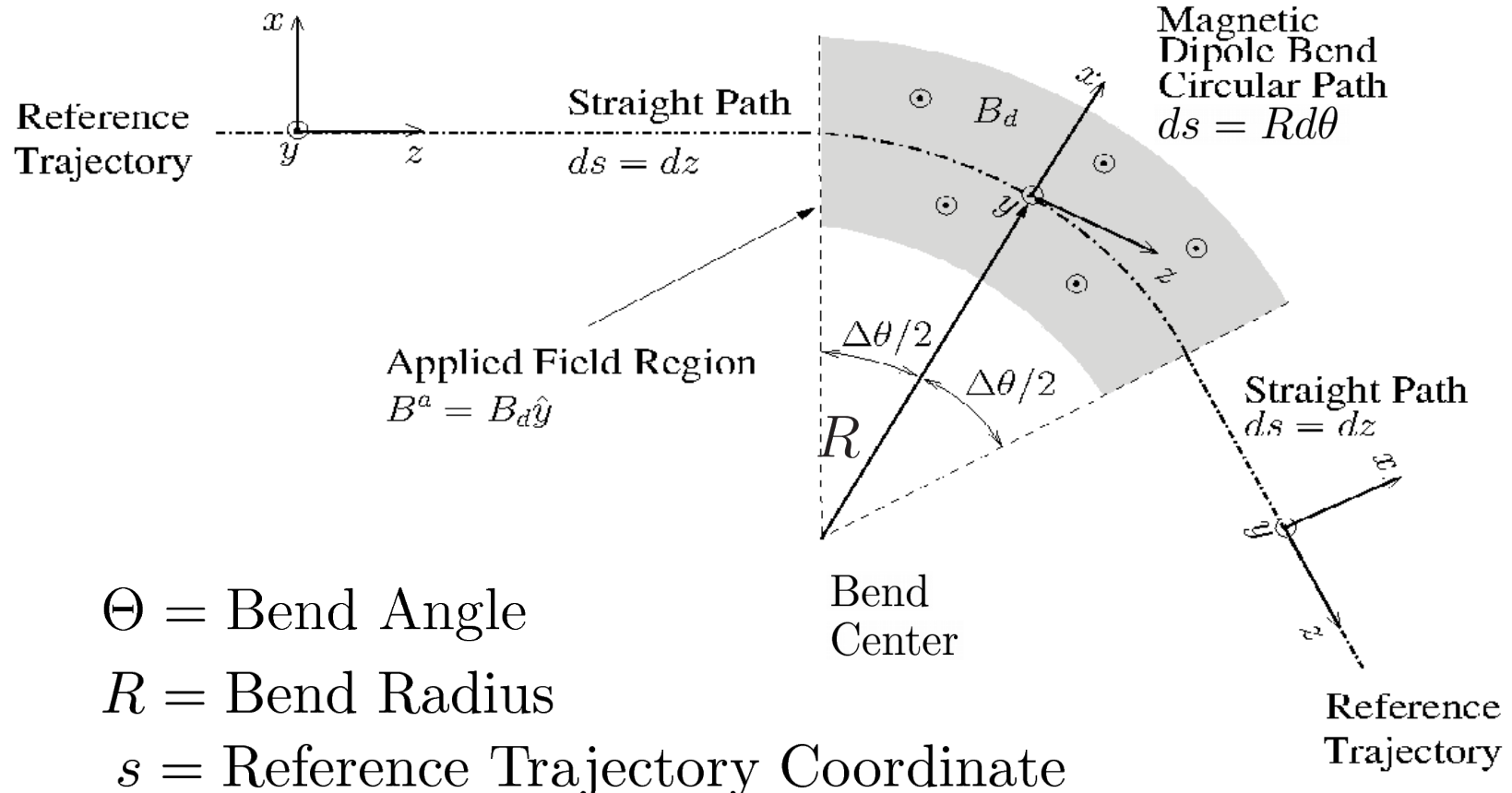

In this perspective, dipoles are adjusted given the design momentum of the reference particle to bend the orbit through a radius R .

- ◆ Bends usually only in one plane (say x)
 - Implemented by a dipole applied field: E_x^a or B_y^a
- ◆ Easy to apply material analogously for y -plane bends, if necessary

Denote:

$$p_0 = m\gamma_b\beta_b c = \text{design momentum}$$

Then a magnetic x -bend through a radius R is specified by:

$$\mathbf{B}^a = B_y^a \hat{\mathbf{y}} = \text{const in bend}$$
$$\frac{1}{R} = \frac{qB_y^a}{p_0}$$

Analogous formula for
Electric Bend will be derived
in problem set

The **particle rigidity** is defined as ($[B\rho]$ read as one symbol called “B-Rho”):

$$[B\rho] \equiv \frac{p_0}{q} = \frac{m\gamma_b\beta_b c}{q}$$

is often applied to express the bend result as:

$$\frac{1}{R} = \frac{B_y^a}{[B\rho]}$$

Comments on bends:

- ◆ R can be **positive** or **negative** depending on sign of $B_y^a / [B\rho]$
- ◆ For **straight** sections, $R \rightarrow \infty$ (or equivalently, $B_y^a = 0$)
- ◆ Lattices often made from discrete element dipoles and straight sections with separated function optics
 - Bends can provide “edge focusing”
 - Sometimes elements for bending/focusing are combined
- ◆ For a ring, dipoles strengths are tuned with particle rigidity/momentum so the reference orbit makes a closed path lap through the circular machine
 - Dipoles adjusted as particles gain energy to maintain closed path
 - In a Synchrotron dipoles and focusing elements are adjusted together to maintain focusing and bending properties as the particles gain energy. This is the origin of the name “Synchrotron.”
- ◆ Total bending strength of a ring in Tesla-meters limits the ultimately achievable particle energy/momentum in the ring

For a magnetic field over a path length S , the beam will be bent through an angle:

$$\Theta = \frac{S}{R} = \frac{SB_y^a}{[B\rho]}$$

To make a ring, the bends must deflect the beam through a total angle of 2π :

- ◆ Neglect any energy gain changing the rigidity over one lap

$$2\pi = \sum_{i, \text{Dipoles}} \Theta_i = \sum_i \frac{S_i}{R_i} = \sum_i \frac{S_i B_{y,i}^a}{[B\rho]}$$

For a symmetric ring, N dipoles are all the same, giving for the bend field:

- ◆ Typically choose parameters for dipole field as high as technology allows for a compact ring

$$B_y^a = 2\pi \frac{[B\rho]}{NS}$$

For a symmetric ring of total circumference C with straight sections of length L between the bends:

- ◆ Features of straight sections typically dictated by needs of focusing, acceleration, and dispersion control

$$C = NS + NL$$

Example: Typical separated function lattice in a Synchrotron

Focus Elements in Red

Bending Elements in Green

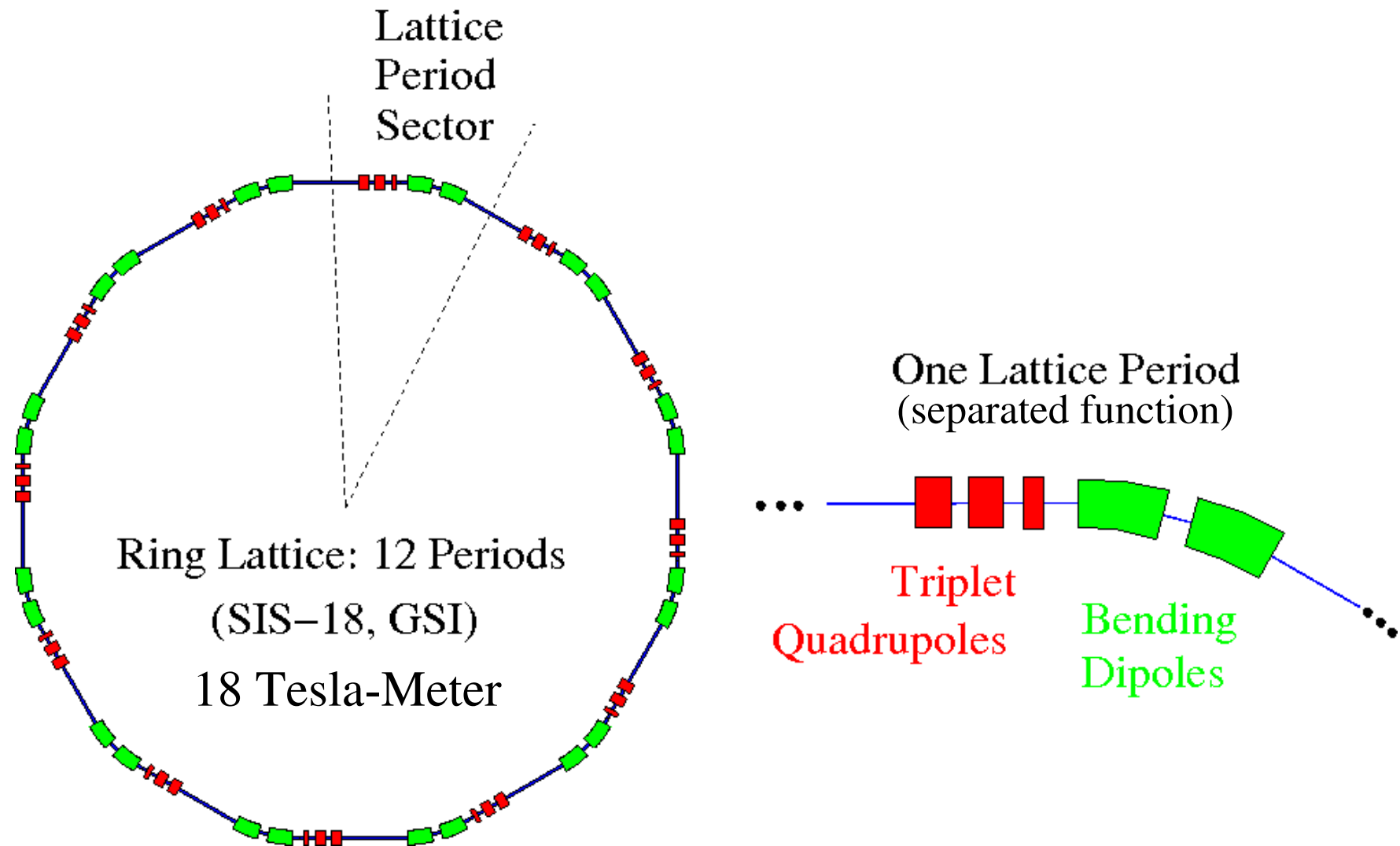

For “off-momentum” errors:

$$p_s = p_0 + \delta p$$

$$p_0 = m\gamma_b\beta_b c = \text{design momentum}$$

$$\delta p = \text{off- momentum}$$

This will modify the particle equations of motion, particularly in cases where there are bends since particles with different momenta will be bent at different radii

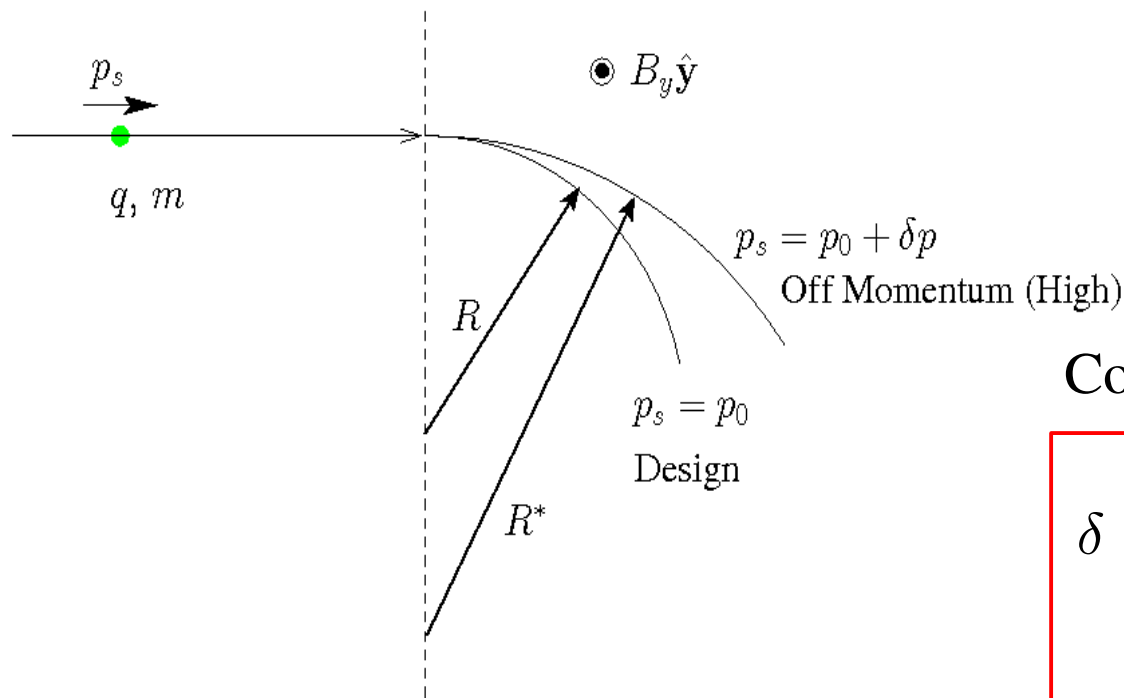

Common notation:

$$\delta \equiv \frac{\delta p}{p_0} = \text{Fractional}$$

Momentum Error

- ◆ Not usual to have acceleration in bends
 - Dipole bends and quadrupole focusing are sometimes combined

Derivatives in accelerator Frenet-Serret Coordinates

Summarize results only needed to transform the Maxwell equations, write field derivatives, etc.

- ◆ Reference: Chao and Tigner, *Handbook of Accelerator Physics and Engineering*

$$\Psi(x, y, s) \quad = \text{Scalar}$$

$$\mathbf{V}(x, y, s) = V_x(x, y, s)\hat{\mathbf{x}} + V_y(x, y, s)\hat{\mathbf{y}} + V_s(x, y, s)\hat{\mathbf{s}} \quad = \text{Vector}$$

Vector Dot and Cross-Products: ($\mathbf{V}_1, \mathbf{V}_2$ Two Vectors)

$$\mathbf{V}_1 \cdot \mathbf{V}_2 = V_{1x}V_{2x} + V_{1y}V_{2y} + V_{1s}V_{2s}$$

$$\begin{aligned} \mathbf{V}_1 \times \mathbf{V}_2 &= \begin{vmatrix} \hat{\mathbf{x}} & \hat{\mathbf{y}} & \hat{\mathbf{s}} \\ V_{1x} & V_{1y} & V_{1s} \\ V_{2x} & V_{2y} & V_{2s} \end{vmatrix} \\ &= (V_{1x}V_{2s} - V_{1s}V_{2x})\hat{\mathbf{x}} + (V_{1s}V_{2x} - V_{1x}V_{2s})\hat{\mathbf{y}} + (V_{1x}V_{2y} - V_{1y}V_{2x})\hat{\mathbf{s}} \end{aligned}$$

Elements:

$$d^2x_{\perp} = dx dy$$

$$d^3x_{\perp} = \left(1 + \frac{x}{R}\right) dx dy ds$$

$$d\vec{\ell} = \hat{\mathbf{x}}dx + \hat{\mathbf{y}}dy + \hat{\mathbf{s}} \left(1 + \frac{x}{R}\right) ds$$

Gradient:

$$\nabla\Psi = \hat{\mathbf{x}}\frac{\partial\Psi}{\partial x} + \hat{\mathbf{y}}\frac{\partial\Psi'}{\partial y} + \hat{\mathbf{s}}\frac{1}{1+x/R}\frac{\partial\Psi}{\partial s}$$

Divergence:

$$\nabla\cdot\mathbf{V} = \frac{1}{1+x/R}\frac{\partial}{\partial x}[(1+x/R)V_x] + \frac{\partial V_y}{\partial y} + \frac{1}{1+x/R}\frac{\partial V_s}{\partial s}$$

Curl:

$$\begin{aligned}\nabla\times\mathbf{V} &= \hat{\mathbf{x}}\left(\frac{\partial V_s}{\partial y} - \frac{1}{1+x/R}\frac{\partial V_y}{\partial s}\right) + \hat{\mathbf{y}}\frac{1}{1+x/R}\left(\frac{\partial V_x}{\partial s} - \frac{\partial}{\partial x}[(1+x/R)V_s]\right) \\ &\quad + \hat{\mathbf{s}}(1+x/R)\left(\frac{\partial V_y}{\partial x} - \frac{\partial V_x}{\partial y}\right)\end{aligned}$$

Laplacian:

$$\nabla^2\Psi = \frac{1}{1+x/R}\frac{\partial}{\partial x}\left[\left(1+\frac{x}{R}\right)\frac{\partial\Psi}{\partial x}\right] + \frac{\partial^2\Psi}{\partial y^2} + \frac{1}{1+x/R}\frac{\partial}{\partial s}\left[\frac{1}{1+x/R}\frac{\partial\Psi}{\partial s}\right]$$

Transverse particle equations of motion including bends and “off-momentum” effects

- ◆ See texts such as Edwards and Syphers for guidance on derivation steps
- ◆ Full derivation is beyond needs/scope of this class

$$\begin{aligned}
 x'' + \frac{(\gamma_b \beta_b)'}{(\gamma_b \beta_b)} x' + \left[\frac{1}{R^2(s)} \frac{1 - \delta}{1 + \delta} \right] x &= \frac{\delta}{1 + \delta} \frac{1}{R(s)} + \frac{q}{m \gamma_b \beta_b^2 c^2} \frac{E_x^a}{(1 + \delta)^2} \\
 &- \frac{q}{m \gamma_b \beta_b c} \frac{B_y^a}{1 + \delta} + \frac{q}{m \gamma_b \beta_b c} \frac{B_s^a}{1 + \delta} y' - \frac{q}{m \gamma_b^3 \beta_b^2 c^2} \frac{1}{1 + \delta} \frac{\partial \phi}{\partial x} \\
 y'' + \frac{(\gamma_b \beta_b)'}{(\gamma_b \beta_b)} y' &= \frac{q}{m \gamma_b \beta_b^2 c^2} \frac{E_y^a}{(1 + \delta)^2} + \frac{q}{m \gamma_b \beta_b c} \frac{B_x^a}{1 + \delta} \\
 &- \frac{q}{m \gamma_b \beta_b c} \frac{B_s^a}{1 + \delta} x' - \frac{q}{m \gamma_b^3 \beta_b^2 c^2} \frac{1}{1 + \delta} \frac{\partial \phi}{\partial y}
 \end{aligned}$$

$p_0 = m \gamma_b \beta_b c = \text{Design Momentum}$

$\delta \equiv \frac{\delta p}{p_0} = \text{Fractional Momentum Error}$

$$\frac{1}{R(s)} = \frac{B_y^a(s)|_{\text{Dipole}}}{[B\rho]} \quad [B\rho] = \frac{p_0}{q}$$

Comments:

- ◆ Design bends only in x and B_y^a , E_x^a contain no dipole terms (design orbit)
 - Dipole components set via the design bend radius $R(s)$
- ◆ Equations contain only low-order terms in momentum spread δ

Comments continued:

- ◆ Equations are often applied linearized in δ
- ◆ Achromatic focusing lattices are often designed using equations with momentum spread to obtain focal points independent of δ to some order
 x and y equations differ significantly due to bends modifying the x -equation when $R(s)$ is finite
- ◆ It will be shown in the problems that for electric bends:

$$\frac{1}{R(s)} = \frac{E_x^a(s)}{\beta_b c [B\rho]}$$

- ◆ Applied fields for focusing: \mathbf{E}_\perp^a , \mathbf{B}_\perp^a , B_s^a
must be expressed in the bent x, y, s system of the reference orbit
 - Includes error fields in dipoles
- ◆ Self fields may also need to be solved taking into account bend terms
 - Often can be neglected in Poisson's Equation

$$\left\{ \frac{1}{1 + x/R} \frac{\partial}{\partial x} \left[\left(1 + \frac{x}{R}\right) \frac{\partial}{\partial x} \right] + \frac{\partial^2}{\partial y^2} + \frac{1}{1 + x/R} \frac{\partial}{\partial s} \left[\frac{1}{1 + x/R} \frac{\partial}{\partial s} \right] \right\} \phi = -\frac{\rho}{\epsilon_0}$$

if $R \rightarrow \infty$

reduces to familiar:
$$\left\{ \frac{\partial^2}{\partial x^2} + \frac{\partial^2}{\partial y^2} + \frac{\partial^2}{\partial s^2} \right\} \phi = -\frac{\rho}{\epsilon_0}$$

Appendix A: Gamma and Beta Factor Conversions

It is frequently the case that functions of the relativistic gamma and beta factors are converted to superficially different appearing forms when analyzing transverse particle dynamics in order to more cleanly express results. Here we summarize useful formulas in that come up when comparing various forms of equations.

Derivatives are taken wrt the axial coordinate s but also apply wrt time t

Results summarized here can be immediately applied in the paraxial approximation by taking:

$$v = |\mathbf{v}| \simeq v_b = \beta_b c \quad \Longrightarrow \quad \begin{aligned} \beta &\simeq \beta_b \\ \gamma &\simeq \gamma_b \end{aligned}$$

Assume that the beam is forward going with $\beta \geq 0$:

$$\begin{aligned} \gamma &\equiv \frac{1}{\sqrt{1 - \beta^2}} & \beta &= \frac{1}{\gamma} \sqrt{\gamma^2 - 1} \\ \gamma^2 &= \frac{1}{1 - \beta^2} & \beta^2 &= 1 - 1/\gamma^2 \end{aligned}$$

A commonly occurring acceleration factor can be expressed in several ways:

- ◆ Depending on choice used, equations can look quite different!

$$\frac{(\gamma\beta)'}{(\gamma\beta)} = \frac{\gamma'}{\gamma} + \frac{\beta'}{\beta} = \frac{\gamma'}{\gamma\beta^2}$$

Axial derivative factors can be converted using:

$$\gamma' = \frac{\beta\beta'}{(1 - \beta^2)^{3/2}} \qquad \beta' = \frac{\gamma'}{\gamma^2 \sqrt{\gamma^2 - 1}}$$

Energy factors:

$$\mathcal{E}_{\text{tot}} = \gamma mc^2 = \mathcal{E} + mc^2$$

$$\gamma\beta = \sqrt{\left(\frac{\mathcal{E}}{mc^2}\right)^2 + 2\left(\frac{\mathcal{E}}{mc^2}\right)}$$

Rigidity:

$$[B\rho] = \frac{p}{q} = \frac{\gamma mv}{q} = \frac{mc}{q} \gamma\beta = \frac{mc}{q} \sqrt{\left(\frac{\mathcal{E}}{mc^2}\right)^2 + 2\left(\frac{\mathcal{E}}{mc^2}\right)}$$

Appendix B: Magnetic Self-Fields

The full Maxwell equations for the beam and applied fields

$$\mathbf{E} = \mathbf{E}^a + \mathbf{E}^s, \quad \text{etc.}$$

with electromagnetic effects neglected can be written as

- ◆ Good approx typically for ions in weak fields

$$\begin{aligned} \nabla \cdot \mathbf{E} &= \frac{\rho}{\epsilon_0} & \nabla \times \mathbf{B} &= \mu_0 \mathbf{J} + \frac{1}{c^2} \frac{\partial}{\partial t} \mathbf{E} \\ \nabla \times \mathbf{E} &= -\frac{\partial}{\partial t} \mathbf{B} & \nabla \cdot \mathbf{B} &= 0 \end{aligned}$$

+ Boundary Conditions on \mathbf{E} and \mathbf{B}
from material structures, radiation conditions, etc.

$$\rho = qn(\mathbf{x}, t)$$

$n(\mathbf{x}, t)$ = Number Density

$$\mathbf{J} = qn(\mathbf{x}, t)\mathbf{V}(\mathbf{x}, t)$$

$\mathbf{V}(\mathbf{x}, t)$ = "Fluid" Flow Velocity

- ◆ Calc from continuum approx distribution

Electrostatic Approx:

$$\nabla \cdot \mathbf{E} = \frac{qn}{\epsilon_0}$$

$$\nabla \times \mathbf{E} = 0$$

$$\mathbf{E} = -\nabla\phi$$

ϕ = Electrostatic

Scalar Potential

$$\implies \nabla \times \mathbf{E} = -\nabla \times \nabla\phi = 0$$

Continuity of mixed
partial derivatives

$$\implies \nabla \cdot \mathbf{E} = -\nabla \cdot \nabla\phi = \frac{qn}{\epsilon_0}$$

$$\nabla^2\phi = -\frac{qn}{\epsilon_0}$$

+ Boundary Conditions on ϕ

Magnetostatic Approx:

$$\nabla \times \mathbf{B} = \mu_0\mathbf{J}$$

$$\nabla \cdot \mathbf{B} = 0$$

$$\mathbf{B} = \nabla \times \mathbf{A}$$

\mathbf{A} = Magnetostatic

Vector Potential

$$\implies \nabla \cdot \mathbf{B} = \nabla \cdot (\nabla \times \mathbf{A}) = 0$$

Continuity of mixed
partial derivatives

$$\implies \nabla \times \mathbf{B} = \nabla \times (\nabla \times \mathbf{A}) = \mu_0\mathbf{J}$$

Continue next slide

Magnetostatic Approx Continued:

$$\nabla \times \mathbf{B} = \nabla \times (\nabla \times \mathbf{A}) = \mu_0 \mathbf{J}$$

$$\nabla \cdot (\nabla \cdot \mathbf{A}) - \nabla^2 \mathbf{A} = \mu_0 \mathbf{J}$$

Still free to take (gauge choice):

$$\nabla \cdot \mathbf{A} = 0 \quad \text{Coulomb Gauge}$$

Can always meet this choice:

$$\mathbf{A} \rightarrow \mathbf{A} + \nabla \xi \quad \xi = \text{Some Function}$$

$$\implies \mathbf{B} = \nabla \times \mathbf{A} \rightarrow \nabla \times \mathbf{A} + \nabla \times \nabla \xi = \nabla \times \mathbf{A}$$

$$\implies \nabla \cdot \mathbf{A} \rightarrow \nabla \cdot \mathbf{A} + \nabla^2 \xi$$

0 Cont mixed partial derivatives

Can always choose ξ such that $\nabla \cdot \mathbf{A} = 0$ to satisfy the Coulomb gauge:

$$\nabla^2 \mathbf{A} = -\mu_0 \mathbf{J} = -\mu_0 qn \mathbf{V}$$

+ Boundary Conditions on \mathbf{A}

◆ Essentially one Poisson form eqn for each field x, y, z comp

But can approximate this further for “typical” paraxial beams

$$\nabla^2 \mathbf{A} = -\mu_0 \mathbf{J} = -\mu_0 q n \mathbf{V}$$

Expect for a beam with primarily forward (paraxial) directed motion:

$$V_z = \beta_b c \quad V_{x,y} \sim R' \beta_b c \quad R' = \text{Beam Envelope Angle} \\ \text{(Typically 10s mrad Magnitude)}$$

$$\implies |A_{x,y}| \ll |A_z|$$

Giving:

$$\nabla^2 A_z = -\mu_0 q \beta_b c n \quad n = -\frac{\epsilon_0}{q} \nabla^2 \phi \quad \text{Free to use from electrostatic part}$$

$$\nabla^2 A_z = -(\mu_0 \epsilon_0) c \beta_b \nabla^2 \phi \quad \mu_0 \epsilon_0 = \frac{1}{c^2} \quad \text{From unit definition}$$

$$\implies A_z = \frac{\beta_b}{c} \phi$$

- Allows simply taking into account low-order self-magnetic field effects
 - Care must be taken if magnetic materials are present close to beam

Further insight can be obtained on the nature of the approximations in the reduced form of the self-magnetic field correction by examining **Lorentz Transformation** properties of the potentials.

From EM theory, the potentials ϕ , $c\mathbf{A}$ form a relativistic 4-vector that transforms as a Lorentz vector for covariance:

$$A_\mu = (\phi, c\mathbf{A})$$

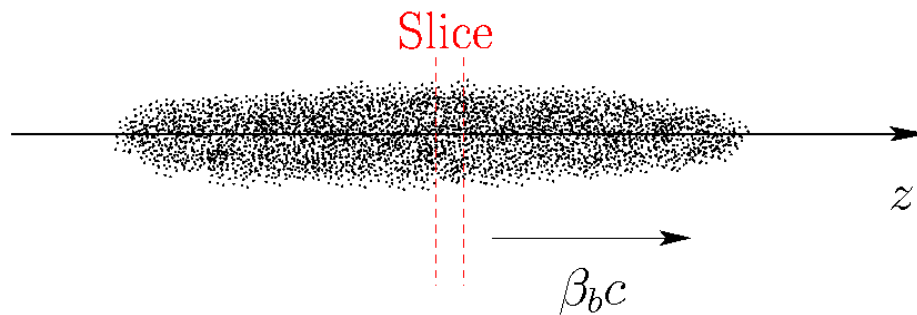

In the rest frame (*) of the beam, assume that the flows are small enough where the potentials are purely electrostatic with:

$$A_\mu^* = (\phi^*, \mathbf{0}) \quad \nabla^2 \phi^* = -\frac{qn^*}{\epsilon_0}$$

Review: Under Lorentz transform, the 4-vector components of $A_\mu = (\phi, c\mathbf{A})$ transform as the familiar 4-vector $x_\mu = (ct, \mathbf{x})$

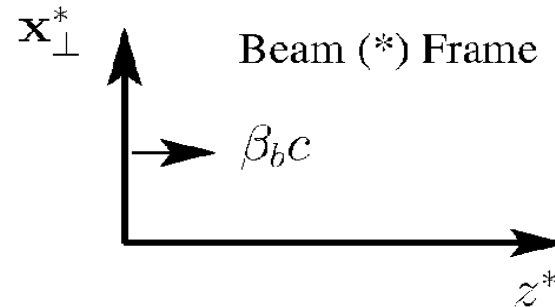
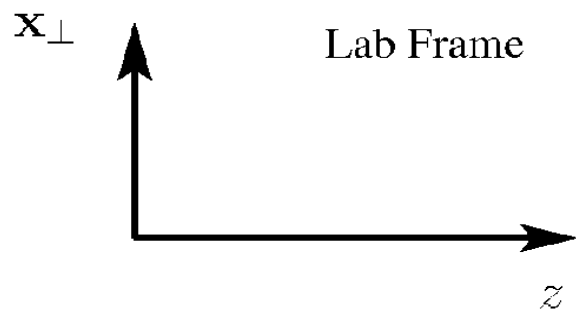

Transform

$$ct^* = \gamma_b(ct - \beta_b z)$$

$$z^* = \gamma_b(z - \beta_b ct)$$

$$\mathbf{x}^* = \mathbf{x}_\perp$$

Inverse Transform

$$ct = \gamma_b(ct^* + \beta_b z^*)$$

$$z = \gamma_b(z^* + \beta_b ct^*)$$

$$\mathbf{x} = \mathbf{x}_\perp^*$$

This gives for the 4-potential $A_\mu = (\phi, c\mathbf{A})$:

$$\phi = \gamma_b(\phi^* + \beta_b cA_z^*) = \gamma_b\phi^*$$

$$cA_z = \gamma_b(cA_z^* + \beta_b\phi^*) = \beta_b(\gamma_b\phi^*) = \beta_b\phi$$

$$\implies A_z = \frac{\beta_b}{c}\phi$$

- Shows result is consistent with pure electrostatic in beam (*) frame

S2: Transverse Particle Equations of Motion in Linear Applied Focusing Channels

S2A: Introduction

Write out transverse particle equations of motion in explicit component form:

$$\begin{aligned}x'' + \frac{(\gamma_b \beta_b)'}{(\gamma_b \beta_b)} x' &= \frac{q}{m \gamma_b \beta_b^2 c^2} E_x^a - \frac{q}{m \gamma_b \beta_b c} B_y^a + \frac{q}{m \gamma_b \beta_b c} B_z^a y' \\ &\quad - \frac{q}{m \gamma_b^3 \beta_b^2 c^2} \frac{\partial \phi}{\partial x} \\ y'' + \frac{(\gamma_b \beta_b)'}{(\gamma_b \beta_b)} y' &= \frac{q}{m \gamma_b \beta_b^2 c^2} E_y^a + \frac{q}{m \gamma_b \beta_b c} B_x^a - \frac{q}{m \gamma_b \beta_b c} B_z^a x' \\ &\quad - \frac{q}{m \gamma_b^3 \beta_b^2 c^2} \frac{\partial \phi}{\partial y}\end{aligned}$$

Equations previously derived under assumptions:

- ◆ No bends (fixed x - y - z coordinate system with no local bends)
- ◆ Paraxial equations ($x'^2, y'^2 \ll 1$)
- ◆ No dispersive effects (β_b same all particles), acceleration allowed ($\beta_b \neq \text{const}$)
- ◆ Electrostatic and leading-order (in β_b) self-magnetic interactions

The applied focusing fields

$$\text{Electric: } E_x^a, E_y^a$$

$$\text{Magnetic: } B_x^a, B_y^a, B_z^a$$

must be specified as a function of s and the transverse particle coordinates x and y to complete the description

- ◆ Consistent change in axial velocity ($\beta_b c$) due to E_z^a must be evaluated
 - Typically due to RF cavities and/or induction cells
- ◆ Restrict analysis to fields from applied focusing structures

Intense beam accelerators and transport lattices are designed to optimize *linear* applied focusing forces with terms:

$$\text{Electric: } E_x^a \simeq (\text{function of } s) \times (x \text{ or } y)$$

$$E_y^a \simeq (\text{function of } s) \times (x \text{ or } y)$$

$$\text{Magnetic: } B_x^a \simeq (\text{function of } s) \times (x \text{ or } y)$$

$$B_y^a \simeq (\text{function of } s) \times (x \text{ or } y)$$

$$B_z^a \simeq (\text{function of } s)$$

Common situations that realize these linear applied focusing forms will be overviewed:

Continuous Focusing (see: [S2B](#))

Quadrupole Focusing

- Electric (see: [S2C](#))

- Magnetic (see: [S2D](#))

Solenoidal Focusing (see: [S2E](#))

Other situations that will not be covered (typically more nonlinear optics):

Einzel Lens (see: J.J. Barnard, [Intro Lectures](#))

Plasma Lens

Wire guiding

Why design around linear applied fields ?

- ◆ Linear oscillators have well understood physics allowing formalism to be developed that can guide design
- ◆ Linear fields are “lower order” so it should be possible for a given source amplitude to generate field terms with greater strength than for “higher order” nonlinear fields

S2B: Continuous Focusing

Assume constant electric field applied focusing force:

$$\mathbf{B}^a = 0$$

$$\mathbf{E}_{\perp}^a = E_x^a \hat{\mathbf{x}} + E_y^a \hat{\mathbf{y}} = -\frac{m\gamma_b\beta_b^2 c^2 k_{\beta 0}^2}{q} \mathbf{x}_{\perp} \quad k_{\beta 0}^2 \equiv \text{const} > 0$$

$$E_z^a = 0$$

$$[k_{\beta 0}] = \frac{\text{rad}}{\text{m}}$$

Continuous focusing equations of motion:

Insert field components into linear applied field equations and collect terms

$$\mathbf{x}_{\perp}'' + \frac{(\gamma_b\beta_b)'}{(\gamma_b\beta_b)} \mathbf{x}_{\perp}' + k_{\beta 0}^2 \mathbf{x}_{\perp} = -\frac{q}{m\gamma_b^3\beta_b^2 c^2} \frac{\partial\phi}{\partial\mathbf{x}_{\perp}}$$

$$x'' + \frac{(\gamma_b\beta_b)'}{(\gamma_b\beta_b)} x' + k_{\beta 0}^2 x = -\frac{q}{m\gamma_b^3\beta_b^2 c^2} \frac{\partial\phi}{\partial x}$$

$$y'' + \frac{(\gamma_b\beta_b)'}{(\gamma_b\beta_b)} y' + k_{\beta 0}^2 y = -\frac{q}{m\gamma_b^3\beta_b^2 c^2} \frac{\partial\phi}{\partial y}$$

Equivalent
Component
Form

Even this simple model can become complicated

- ◆ **Space charge:** ϕ must be calculated consistent with beam evolution
- ◆ **Acceleration:** acts to damp orbits (see: **S10**)

Simple model in limit of no acceleration ($\gamma_b\beta_b \simeq \text{const}$) and negligible space-charge ($\phi \simeq \text{const}$):

$$\mathbf{x}''_{\perp} + k_{\beta 0}^2 \mathbf{x}_{\perp} = 0 \quad \Longrightarrow \quad \text{orbits simple harmonic oscillatons}$$

General solution is elementary:

$$\mathbf{x}_{\perp} = \mathbf{x}_{\perp}(s_i) \cos[k_{\beta 0}(s - s_i)] + [\mathbf{x}'_{\perp}(s_i)/k_{\beta 0}] \sin[k_{\beta 0}(s - s_i)]$$

$$\mathbf{x}'_{\perp} = -k_{\beta 0} \mathbf{x}_{\perp}(s_i) \sin[k_{\beta 0}(s - s_i)] + \mathbf{x}'_{\perp}(s_i) \cos[k_{\beta 0}(s - s_i)]$$

$$\mathbf{x}_{\perp}(s_i) = \text{Initial coordinate}$$

$$\mathbf{x}'_{\perp}(s_i) = \text{Initial angle}$$

In terms of a transfer map in the x -plane (y -plane analogous):

$$\begin{bmatrix} x \\ x' \end{bmatrix}_s = \mathbf{M}_x(s|s_i) \cdot \begin{bmatrix} x \\ x' \end{bmatrix}_{s_i}$$

$$\mathbf{M}_x(s|s_i) = \begin{bmatrix} \cos[k_{\beta 0}(s - s_i)] & \frac{1}{k_{\beta 0}} \sin[k_{\beta 0}(s - s_i)] \\ -k_{\beta 0} \sin[k_{\beta 0}(s - s_i)] & \cos[k_{\beta 0}(s - s_i)] \end{bmatrix}$$

/// Example: Particle Orbits in Continuous Focusing

Particle phase-space in $x-x'$ with only applied field

$$\begin{aligned} k_{\beta 0} &= 2\pi \text{ rad/m} & x(0) &= 1 \text{ mm} & y(0) &= 0 \\ \phi &\simeq 0 & \gamma_b \beta_b &= \text{const} & x'(0) &= 0 & y'(0) &= 0 \end{aligned}$$

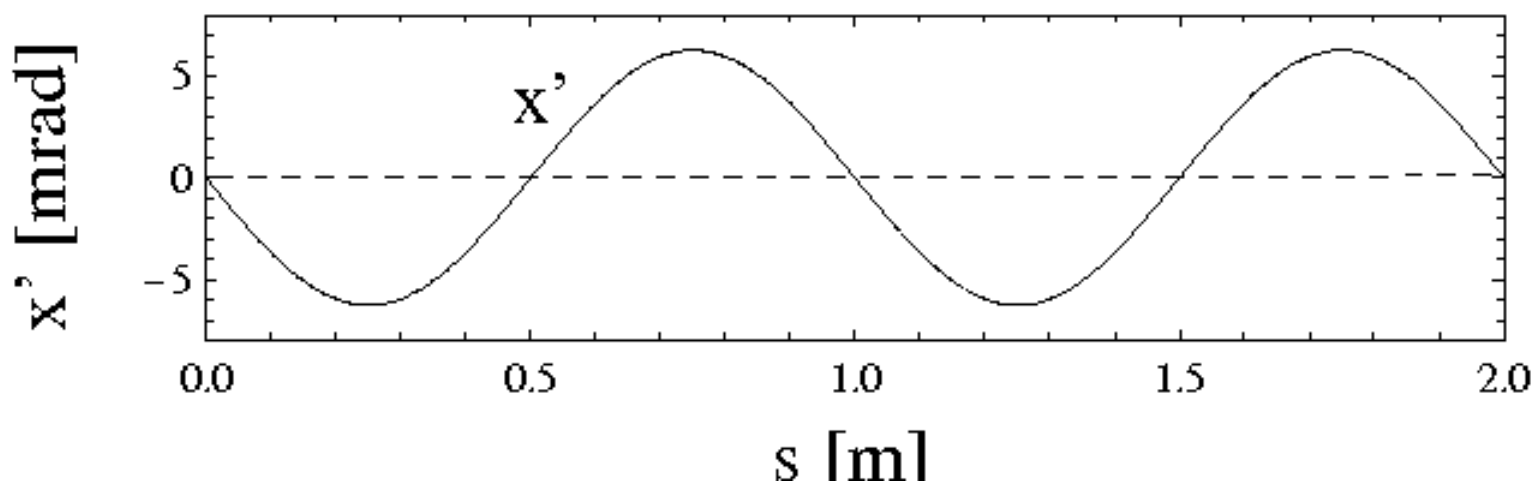
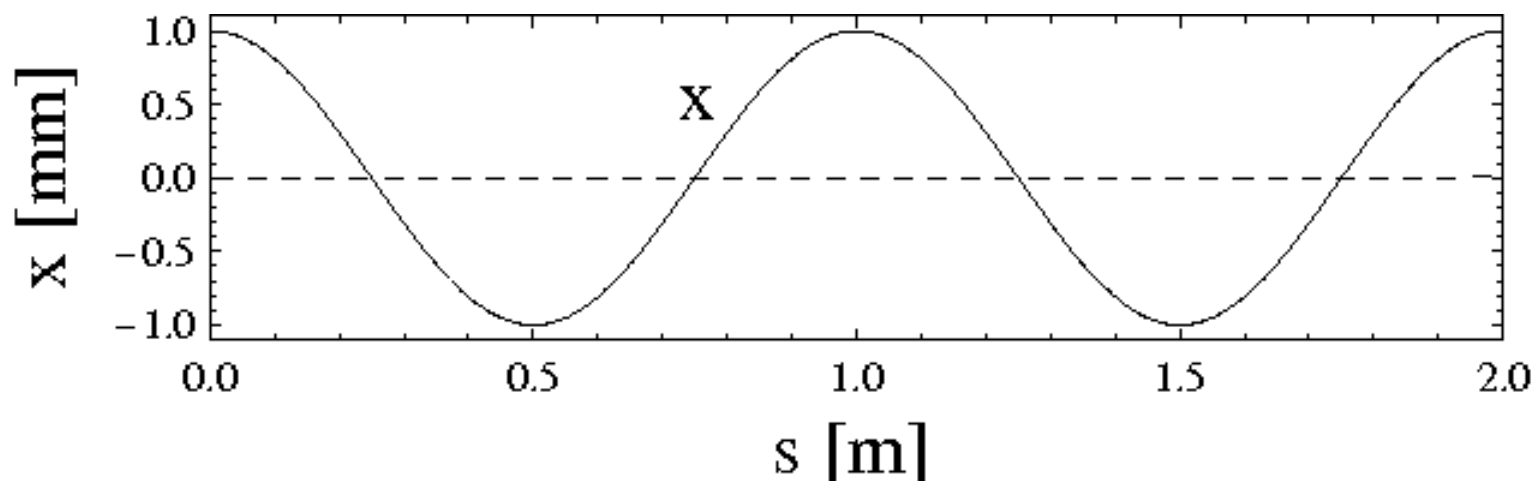

◆ Orbits in the applied field are just simple harmonic oscillators

///

Problem with continuous focusing model:

The continuous focusing model is realized by a stationary ($m \rightarrow \infty$) partially neutralizing uniform background of charges filling the beam pipe. To see this apply Maxwell's equations to the applied field to calculate an applied charge density:

$$\rho^a = \epsilon_0 \frac{\partial}{\partial \mathbf{x}} \cdot \mathbf{E}^a = -\frac{2m\epsilon_0\gamma_b\beta_b^2 c^2 k_{\beta 0}^2}{q} = \text{const}$$

- ◆ Unphysical model, but commonly employed since it represents the average action of more physical focusing fields in a simpler to analyze model
 - Demonstrate later in simple examples and problems given
- ◆ Continuous focusing can provide reasonably good estimates for more realistic periodic focusing models if $k_{\beta 0}^2$ is appropriately identified in terms of “equivalent” parameters *and* the periodic system is stable.
 - See lectures that follow and homework problems for examples

In more realistic models, one requires that *quasi-static* focusing fields in the machine aperture satisfy the **vacuum Maxwell equations**

$$\begin{array}{ll} \nabla \cdot \mathbf{E}^a = 0 & \nabla \cdot \mathbf{B}^a = 0 \\ \nabla \times \mathbf{E}^a = 0 & \nabla \times \mathbf{B}^a = 0 \end{array}$$

- ◆ Require in the region of the beam
- ◆ Applied field sources outside of the beam region

The vacuum Maxwell equations constrain the 3D form of applied fields resulting from spatially localized lenses. The following cases are commonly exploited to optimize **linear** focusing strength in physically realizable systems while keeping the model relatively simple:

- 1) **Alternating Gradient Quadrupoles** with transverse orientation
 - Electric Quadrupoles (see: **S2C**)
 - Magnetic Quadrupoles (see: **S2D**)
- 2) **Solenoidal Magnetic Fields** with longitudinal orientation (see: **S2E**)
- 3) **Einzel Lenses** (see J.J. Barnard, **Introductory Lectures**)

S2C: Alternating Gradient Quadrupole Focusing

Electric Quadrupoles

In the axial center of a long **electric quadrupole**, model the fields as 2D transverse

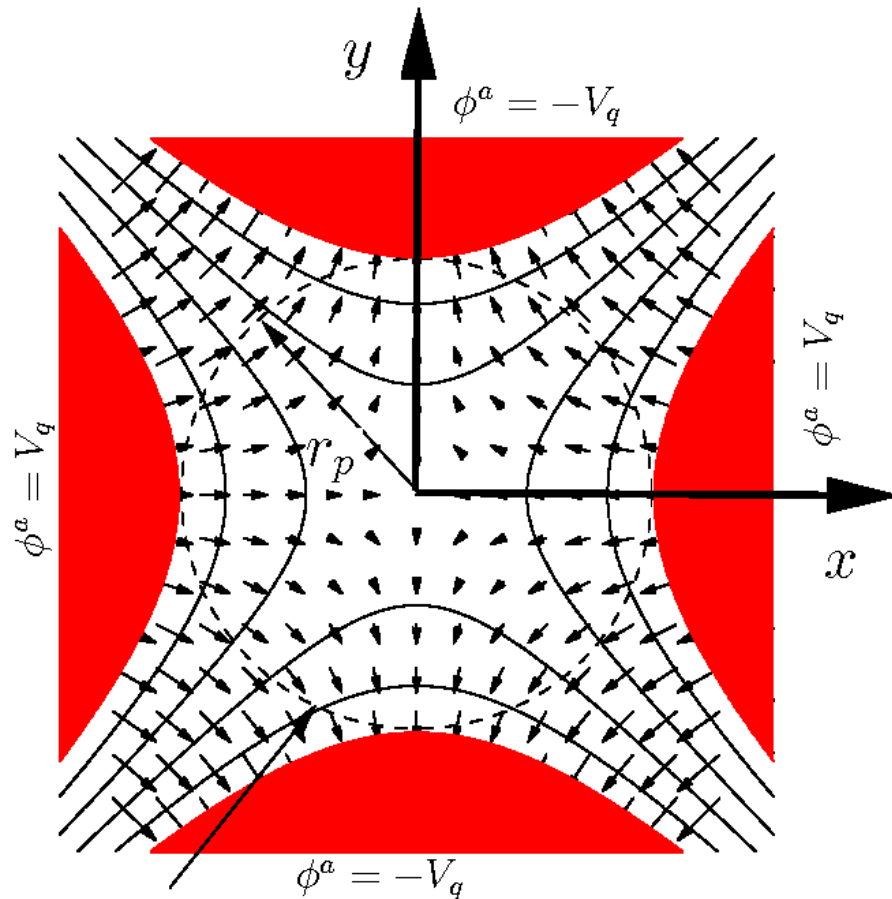

Electrodes Outside of Circle $r = r_p$
 Electrodes: $x^2 - y^2 = \mp r_p^2$

- ◆ Electrodes hyperbolic
- ◆ Structure infinitely extruded along z

2D Transverse Fields

$$\mathbf{B}^a = 0$$

$$E_x^a = -Gx$$

$$E_y^a = Gy$$

$$E_z^a = 0$$

$$G \equiv \frac{2V_q}{r_p^2} = -\frac{\partial E_x^a}{\partial x} = \frac{\partial E_y^a}{\partial y}$$

= Electric Gradient

$$V_q = \text{Pole Voltage}$$

$$r_p = \text{Pipe Radius (clear aperture)}$$

//Aside: How can you calculate these fields?

Fields satisfy within vacuum aperture:

$$\begin{aligned}\nabla \cdot \mathbf{E}^a &= 0 \\ \nabla \times \mathbf{E}^a &= 0\end{aligned}\quad \Longrightarrow \quad \mathbf{E}^a = -\nabla\phi^a$$

Choose a long axial structure with 2D hyperbolic potential surfaces:

$$\phi^a = \text{const}(x^2 - y^2)$$

Require: $\phi^a = V_q$ at $x = r_p, y = 0$ \Longrightarrow $\text{const} = V_q/r_p^2$

$$\begin{aligned}\phi^a &= \frac{V_q}{r_p^2}(x^2 - y^2) \\ \Rightarrow E_x^a &= -\frac{\partial\phi^a}{\partial x} = \frac{-2V_q}{r_p^2}x \equiv -Gx \\ \Rightarrow E_y^a &= -\frac{\partial\phi^a}{\partial y} = \frac{2V_q}{r_p^2}y \equiv Gy\end{aligned}\quad G \equiv \frac{2V_q}{r_p^2}$$

Realistic geometries can be considerably more complicated

- ▶ Truncated hyperbolic electrodes transversely, truncated structure in z

//

Quadrupoles actually have finite axial length in z . Model this by taking the gradient G to vary in s , i.e., $G = G(s)$ with $s = z - z_{\text{center}}$ (straight section)

- ◆ Variation is called the **fringe-field** of the focusing element
- ◆ Variation will violate the Maxwell Equations in 3D
 - Provides a reasonable first approximation in many applications
- ◆ Usually quadrupole is long, and $G(s)$ will have a flat central region and rapid variation near the ends

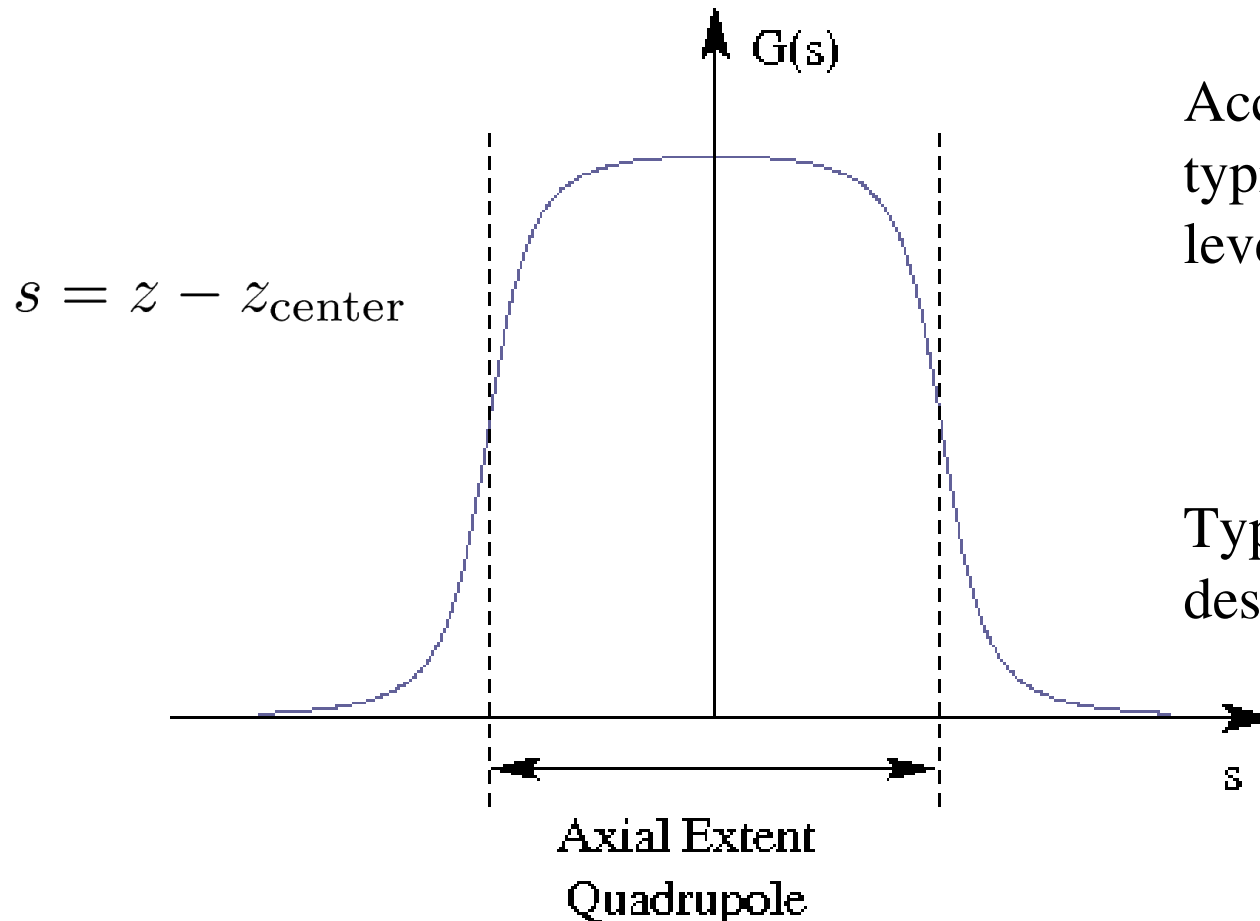

Accurate fringe calculation typically requires higher level modeling:

3D analysis

Detailed geometry

Typically employ magnetic design codes

For many applications the actual quadrupole fringe function $G(s)$ is replaced by a simpler function to allow more idealized modeling

- ◆ Replacements should be made in an “equivalent” parameter sense to be detailed later (see: lectures on **Transverse Centroid and Envelope Modeling**)
- ◆ Fringe functions often replaced in design studies by **piecewise constant** $G(s)$
 - Commonly called “**hard-edge**” approximation
- ◆ See **S3** and Lund and Bukh, PRSTAB 7 924801 (2004), Appendix C for more details on equivalent models

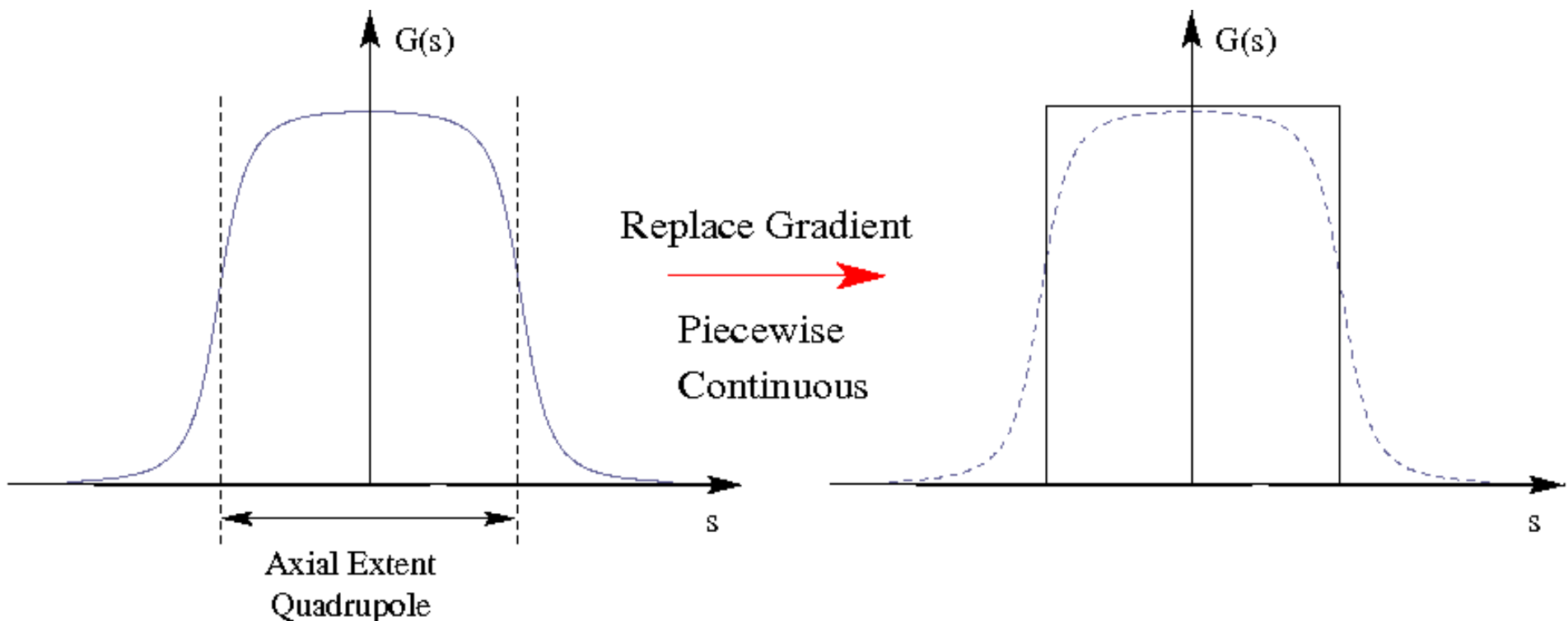

Electric quadrupole equations of motion:

- ◆ Insert applied field components into linear applied field equations and collect terms

$$x'' + \frac{(\gamma_b \beta_b)'}{(\gamma_b \beta_b)} x' + \kappa(s)x = -\frac{q}{m\gamma_b^3 \beta_b^2 c^2} \frac{\partial \phi}{\partial x}$$

$$y'' + \frac{(\gamma_b \beta_b)'}{(\gamma_b \beta_b)} y' - \kappa(s)y = -\frac{q}{m\gamma_b^3 \beta_b^2 c^2} \frac{\partial \phi}{\partial y}$$

$$\kappa(s) = \frac{qG}{m\gamma_b \beta_b^2 c^2} = \frac{G}{\beta_b c [B\rho]}$$

$$G = -\frac{\partial E_x^a}{\partial x} = \frac{\partial E_y^a}{\partial y} = \frac{2V_q}{r_p^2} \quad [B\rho] = \frac{m\gamma_b \beta_b c}{q}$$

- ◆ For **positive/negative** κ , the applied forces are **Focusing/deFocusing** in the x - and y -planes
- ◆ The x - and y -equations are decoupled
- ◆ Valid whether the the focusing function κ is piecewise constant or incorporates a fringe model

Simple model in limit of no acceleration ($\gamma_b\beta_b \simeq \text{const}$) and negligible space-charge ($\phi \simeq \text{const}$) and $\kappa = \text{const}$:

$$x'' + \kappa x = 0$$

$$y'' - \kappa y = 0$$

\implies orbits harmonic or hyperbolic depending on sign of κ

General solution:

$\kappa > 0$:

$$x = x_i \cos[\sqrt{\kappa}(s - s_i)] + (x'_i/\sqrt{\kappa}) \sin[\sqrt{\kappa}(s - s_i)]$$

$$x' = -\sqrt{\kappa}x_i \sin[\sqrt{\kappa}(s - s_i)] + x'_i \cos[\sqrt{\kappa}(s - s_i)]$$

$$x(s_i) = x_i = \text{Initial coordinate}$$

$$x'(s_i) = x'_i = \text{Initial angle}$$

$$y = y_i \cosh[\sqrt{\kappa}(s - s_i)] + (y'_i/\sqrt{\kappa}) \sinh[\sqrt{\kappa}(s - s_i)]$$

$$y' = \sqrt{\kappa}y_i \sinh[\sqrt{\kappa}(s - s_i)] + y'_i \cosh[\sqrt{\kappa}(s - s_i)]$$

$$y(s_i) = y_i = \text{Initial coordinate}$$

$$y'(s_i) = y'_i = \text{Initial angle}$$

$\kappa < 0$:

Exchange x and y in $\kappa > 0$ case.

In terms of a transfer maps:

$\kappa > 0$:

$$\begin{bmatrix} x \\ x' \end{bmatrix}_s = \mathbf{M}_x(s|s_i) \cdot \begin{bmatrix} x \\ x' \end{bmatrix}_{s_i}$$

$$\begin{bmatrix} y \\ y' \end{bmatrix}_s = \mathbf{M}_y(s|s_i) \cdot \begin{bmatrix} y \\ y' \end{bmatrix}_{s_i}$$

$$\mathbf{M}_x(s|s_i) = \begin{bmatrix} \cos[\sqrt{\kappa}(s - s_i)] & \frac{1}{\sqrt{\kappa}} \sin[\sqrt{\kappa}(s - s_i)] \\ -\sqrt{\kappa} \sin[\sqrt{\kappa}(s - s_i)] & \cos[\sqrt{\kappa}(s - s_i)] \end{bmatrix}$$

$$\mathbf{M}_y(s|s_i) = \begin{bmatrix} \cosh[\sqrt{\kappa}(s - s_i)] & \frac{1}{\sqrt{\kappa}} \sinh[\sqrt{\kappa}(s - s_i)] \\ \sqrt{\kappa} \sinh[\sqrt{\kappa}(s - s_i)] & \cosh[\sqrt{\kappa}(s - s_i)] \end{bmatrix}$$

$\kappa < 0$:

Exchange x and y in $\kappa > 0$ case.

Quadrupoles must be arranged in a lattice where the particles traverse a sequence of optics with **alternating gradient** to focus strongly in both transverse directions

- ◆ Alternating gradient necessary to provide focusing in both x - and y -planes
- ◆ **Alternating Gradient Focusing** often abbreviated “**AG**” and is sometimes called “**Strong Focusing**”
- ◆ FODO is acronym:
 - **F** (Focus) in plane placed where excursions (on average) are small
 - **D** (deFocus) placed where excursions (on average) are large
 - **O** (drift) allows axial separation between elements
- ◆ Focusing lattices often (but not necessarily) periodic
 - Periodic expected to give optimal efficiency in focusing with quadrupoles
- ◆ Drifts between F and D quadrupoles allow space for: acceleration cells, beam diagnostics, vacuum pumping,
- ◆ Focusing strength must be limited for stability (see **S5**)

Example **Quadrupole FODO periodic lattices** with piecewise constant κ

- ◆ FODO: [Focus drift(O) DeFocus Drift(O)] has equal length drifts and same length F and D quadrupoles
- ◆ FODO is simplest possible realization of “alternating gradient” focusing
 - Can also have thin lens limit of finite axial length magnets in FODO lattice

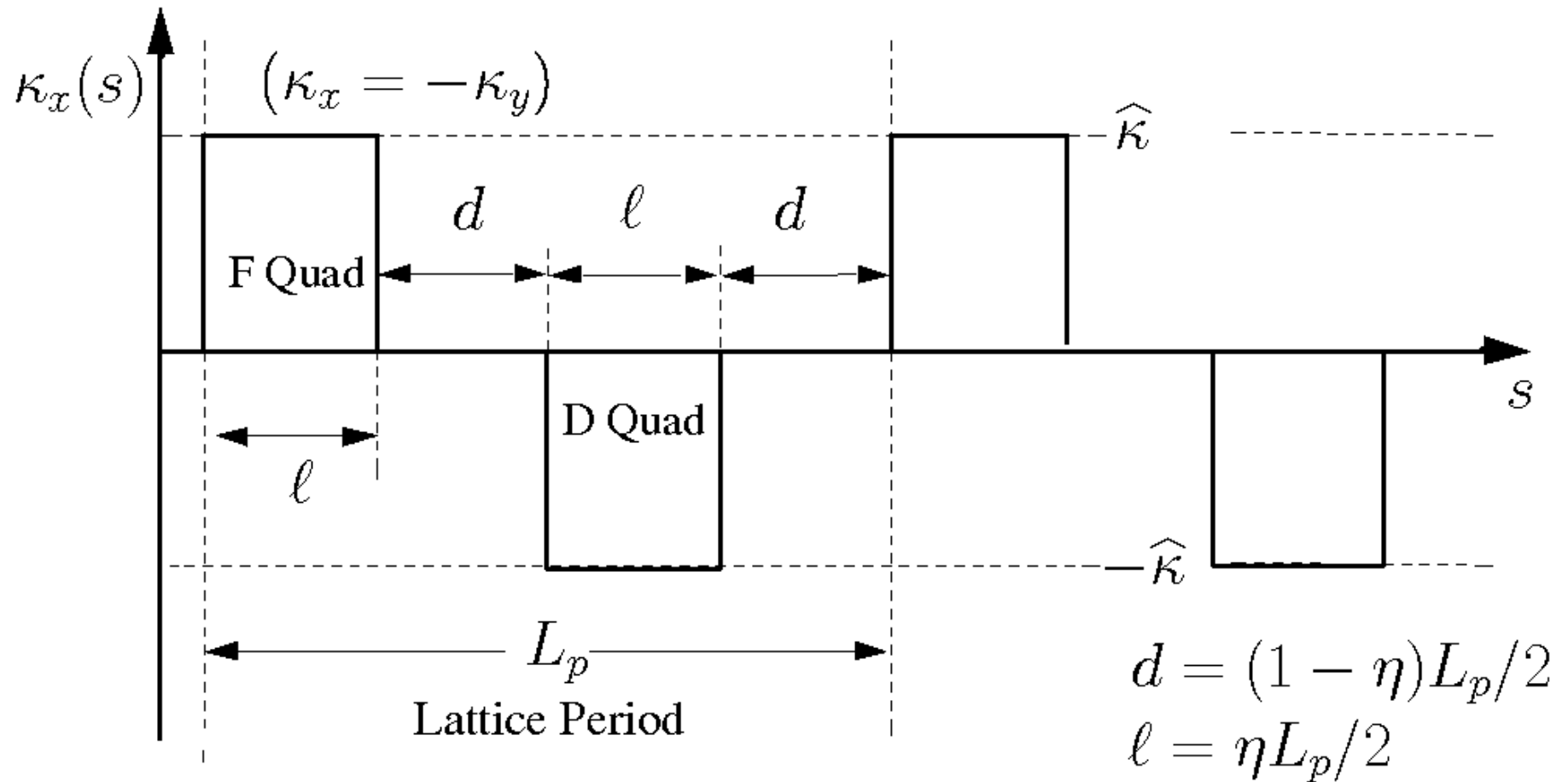

$\eta = \text{Occupancy} \in (0, 1]$

/// Example: Particle Orbits in a FODO Periodic Quadrupole Focusing Lattice:

Particle phase-space in $x-x'$ with only hard-edge applied field

$$L_p = 0.5 \text{ m} \quad \kappa = \pm 50 \text{ rad/m}^2 \text{ in Quads} \quad x(0) = 1 \text{ mm} \quad y(0) = 0$$

$$\eta = 0.5 \quad \phi \simeq 0 \quad \gamma_b \beta_b = \text{const} \quad x'(0) = 0 \quad y'(0) = 0$$

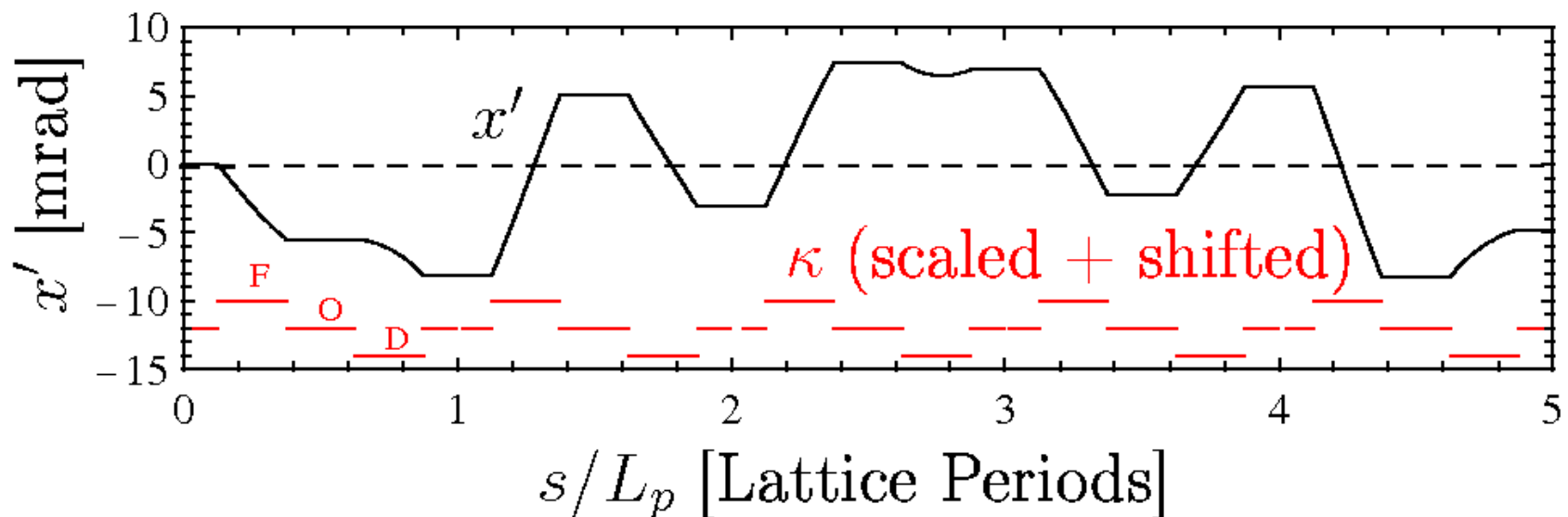
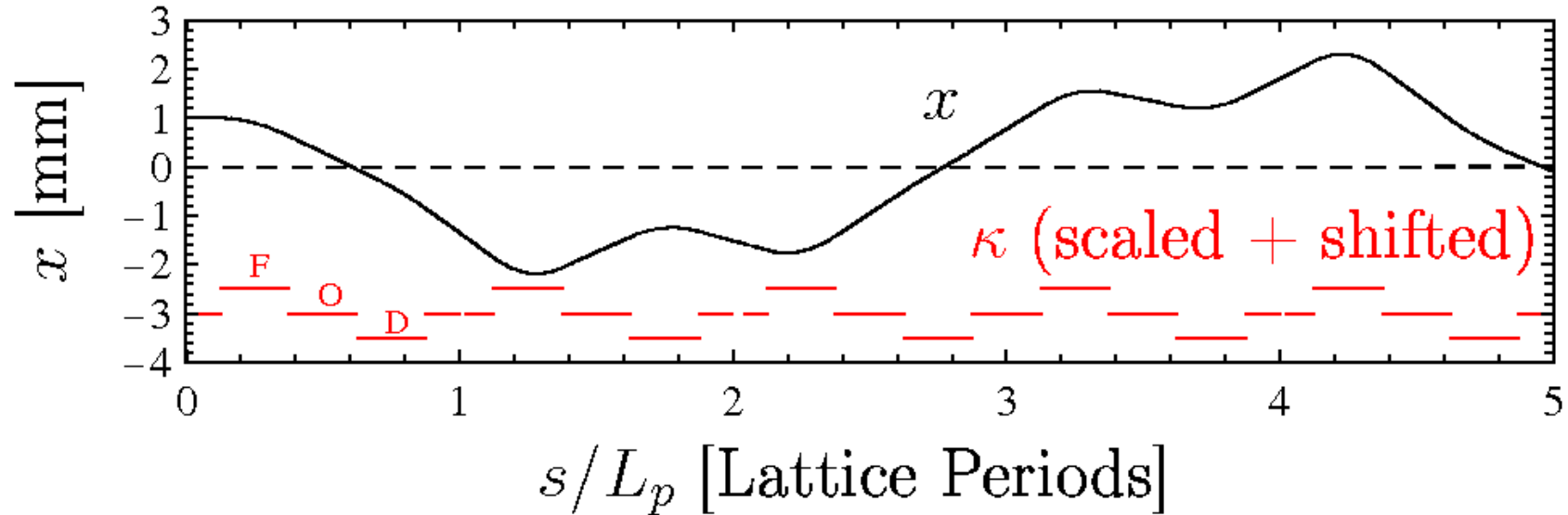

Comments on Orbits:

- ◆ Orbits strongly deviate from simple harmonic form due to AG focusing
 - Multiple harmonics present
- ◆ Orbit tends to be farther from axis in focusing quadrupoles and closer to axis in defocusing quadrupoles to provide net focusing
- ◆ Will find later that if the focusing is sufficiently strong, the orbit can become unstable (see: S5)
- ◆ y -orbit has the same properties as x -orbit due to the periodic structure and AG focusing
- ◆ If quadrupoles are rotated about their z -axis of symmetry, then the x - and y -equations become cross-coupled. This is called quadrupole skew coupling (see: Appendix A) and complicates the dynamics.

Some properties of particle orbits in quadrupoles with $\kappa = \text{const}$ will be analyzed in the problem sets

S2D: Alternating Gradient Quadrupole Focusing

Magnetic Quadrupoles

In the axial center of a long magnetic quadrupole, model fields as 2D transverse

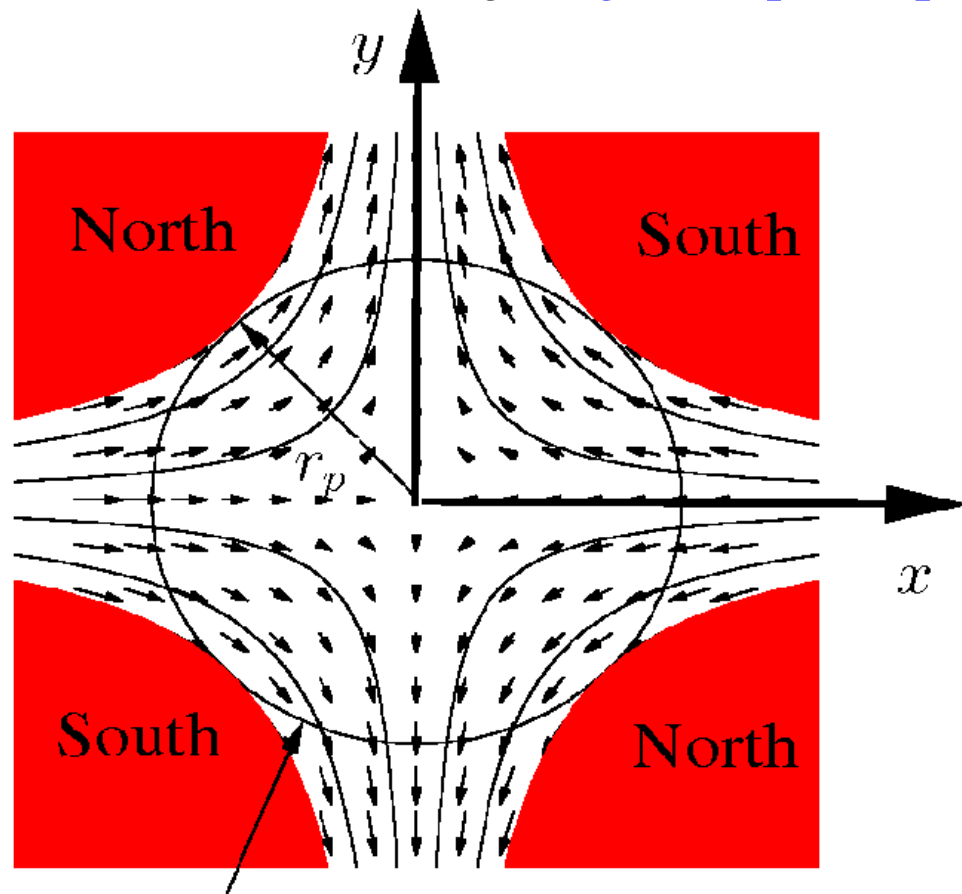

Conducting Beam Pipe: $r = r_p$
 Poles: $xy = \pm \frac{r_p^2}{2}$

- ◆ Magnetic (ideal iron) poles hyperbolic
- ◆ Structure infinitely extruded along z

2D Transverse Fields

$$\mathbf{E}^a = 0$$

$$B_x^a = Gy$$

$$B_y^a = Gx$$

$$B_z^a = 0$$

$$G \equiv \frac{B_q}{r_p} = \frac{\partial B_x^a}{\partial y} = \frac{\partial B_y^a}{\partial x}$$

= Magnetic Gradient

$$B_q = |\mathbf{B}^a|_{r=r_p} = \text{Pole Field}$$

$$r_p = \text{Pipe Radius}$$

//Aside: How can you calculate these fields?

Fields satisfy within vacuum aperture:

$$\begin{aligned}\nabla \cdot \mathbf{B}^a &= 0 \\ \nabla \times \mathbf{B}^a &= 0\end{aligned}\quad \Longrightarrow \quad \mathbf{B}^a = -\nabla \phi^a$$

Analogous to electric case, BUT magnetic force is different so rotate potential surfaces by 45 degrees:

Electric

$$\mathbf{F}_\perp = -q \frac{\partial \phi^a}{\partial \mathbf{x}_\perp}$$

$$\phi^a = \text{const}(x^2 - y^2)$$

Magnetic

$$\mathbf{F}_\perp = -q\beta_b c \hat{\mathbf{z}} \times \frac{\partial \phi^a}{\partial \mathbf{x}_\perp}$$

expect electric potential form rotated by 45 degrees ...

$$x \rightarrow \frac{1}{\sqrt{2}}x - \frac{1}{\sqrt{2}}y$$

$$y \rightarrow \frac{1}{\sqrt{2}}x + \frac{1}{\sqrt{2}}y$$

$$\phi^a \rightarrow \phi^a = -\text{const} \cdot xy$$

$$\begin{aligned} B_x^a &= -\frac{\partial \phi^a}{\partial x} = \text{const} \cdot x \\ \implies B_y^a &= -\frac{\partial \phi^a}{\partial y} = \text{const} \cdot y \end{aligned}$$

$$\text{Require: } |\mathbf{B}^a| = B_p \quad \text{at } r = \sqrt{x^2 + y^2} = r_p \quad \implies \quad \text{const} = B_p/r_p$$

$$\implies \phi^a = -\frac{B_p}{r_p} xy \qquad G = \frac{B_p}{r_p}$$

Realistic geometries can be considerably more complicated

- ◆ Truncated hyperbolic poles, truncated structure in z
- ◆ Both effects give nonlinear focusing terms

Analogously to the electric quadrupole case, take $G = G(s)$

- ◆ Same comments made on electric quadrupole fringe in **S2C** are directly applicable to magnetic quadrupoles

Magnetic quadrupole equations of motion:

- ◆ Insert field components into linear applied field equations and collect terms

$$x'' + \frac{(\gamma_b \beta_b)'}{(\gamma_b \beta_b)} x' + \kappa(s)x = -\frac{q}{m\gamma_b^3 \beta_b^2 c^2} \frac{\partial \phi}{\partial x}$$

$$y'' + \frac{(\gamma_b \beta_b)'}{(\gamma_b \beta_b)} y' - \kappa(s)y = -\frac{q}{m\gamma_b^3 \beta_b^2 c^2} \frac{\partial \phi}{\partial y}$$

$$\kappa(s) = \frac{qG}{m\gamma_b \beta_b c} = \frac{G}{[B\rho]}$$

$$G = \frac{\partial B_x^a}{\partial y} = \frac{\partial B_y^a}{\partial x} = \frac{B_q}{r_p} \quad [B\rho] = \frac{m\gamma_b \beta_b c}{q}$$

- ◆ Equations identical to the electric quadrupole case in terms of $\kappa(s)$
- ◆ All comments made on electric quadrupole focusing lattice are immediately applicable to magnetic quadrupoles: just apply different κ definitions in design
- ◆ Scaling of κ with energy different than electric case impacts applicability

$$\kappa = \begin{cases} \frac{G}{\beta_b c [B\rho]} & \text{Electric Focusing; } G = \frac{\partial E_y^a}{\partial y} = \frac{2V_q}{r_p^2} \\ \frac{G}{[B\rho]} & \text{Magnetic Focusing; } G = \frac{\partial B_x^a}{\partial y} = \frac{B_q}{r_p} \end{cases}$$

- ◆ Electric focusing weaker for higher particle energy (larger β_b)
- ◆ Technical limit values of gradients
 - Voltage holding for electric
 - Material properties (iron saturation, superconductor limits, ...) for magnetic
- ◆ See **JJB Intro** lectures for discussion on focusing technology choices

Different energy dependence also gives different **dispersive properties** when beam has axial momentum spread:

$$\delta \equiv \frac{\delta p}{p_0} = \text{Fractional Momentum Error}$$

$$\kappa \rightarrow \begin{cases} \frac{\kappa}{(1+\delta)^2} & \text{Electric Focusing} \\ \frac{\kappa}{1+\delta} & \text{Magnetic Focusing} \end{cases}$$

- ◆ Electric case further complicated because δ couples to the transverse motion since particles crossing higher electrostatic potentials are accelerated/deaccelerated

S2E: Solenoidal Focusing

The field of an ideal **magnetic solenoid** is invariant under transverse rotations about its axis of symmetry (z) can be expanded in terms of the on-axis field as as:

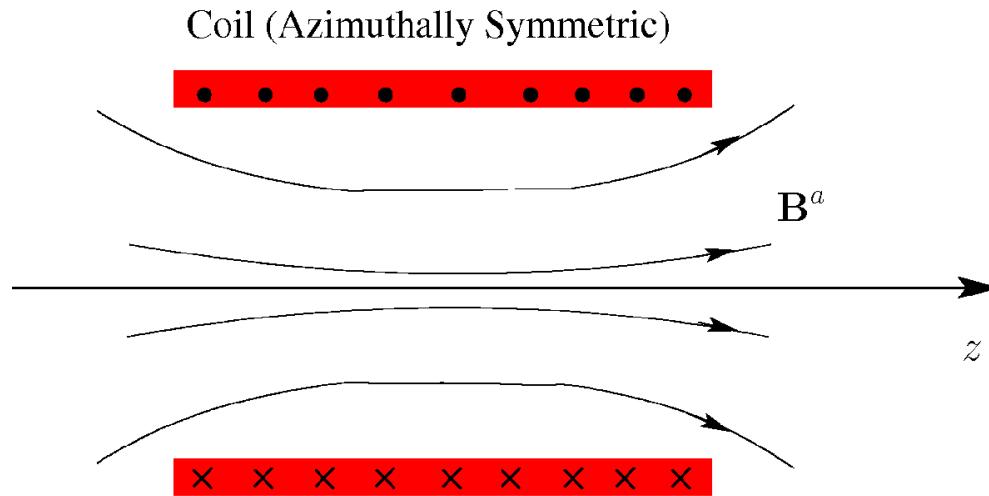

Vacuum Maxwell equations:

$$\nabla \cdot \mathbf{B}^a = 0$$

$$\nabla \times \mathbf{B}^a = 0$$

Imply \mathbf{B}^a can be expressed in terms of on-axis field $\mathbf{B}_z^a(r=0, z)$

$$\mathbf{E}^a = 0$$

$$\mathbf{B}_\perp^a = \frac{1}{2} \sum_{\nu=1}^{\infty} \frac{(-1)^\nu}{\nu!(\nu-1)!} \frac{\partial^{2\nu-1} B_{z0}(z)}{\partial z^{2\nu-1}} \left(\frac{|\mathbf{x}_\perp|}{2} \right)^{2\nu-2} \mathbf{x}_\perp$$

$$B_z^a = B_{z0}(z) + \sum_{\nu=1}^{\infty} \frac{(-1)^\nu}{(\nu!)^2} \frac{\partial^{2\nu} B_{z0}(z)}{\partial z^{2\nu}} \left(\frac{|\mathbf{x}_\perp|}{2} \right)^{2\nu}$$

$$B_{z0}(z) \equiv B_z^a(\mathbf{x}_\perp = 0, z) = \text{On-Axis Field}$$

See
Appendix D
 or
 Reiser,
*Theory and Design
 of Charged
 Particle Beams*,
 Sec. 3.3.1

Writing out explicitly the terms of this expansion:

$$\mathbf{B}^a(r, z) = \hat{\mathbf{r}}B_r^a(r, z) + \hat{\mathbf{z}}B_z^a(r, z) \quad r = \sqrt{x^2 + y^2}$$

$$= (-\hat{\mathbf{x}} \sin \theta + \hat{\mathbf{y}} \cos \theta)B_r^a(r, z) + \hat{\mathbf{z}}B_z^a(r, z)$$

where

$$B_r^a(r, z) = \sum_{\nu=1}^{\infty} \frac{(-1)^\nu}{\nu!(\nu-1)!} B_{z0}^{(2\nu-1)}(z) \left(\frac{r}{2}\right)^{2\nu-1}$$

$$= -\frac{B'_{z0}(z)}{2}r + \frac{B_{z0}^{(3)}(z)}{16}r^3 - \frac{B_{z0}^{(5)}(z)}{384}r^5 + \frac{B_{z0}^{(7)}(z)}{18432}r^7 - \frac{B_{z0}^{(9)}(z)}{1474560}r^9 + \dots$$

$$B_z^a(r, z) = \sum_{\nu=0}^{\infty} \frac{(-1)^\nu}{(\nu!)^2} B_{z0}^{(2\nu)}(z) \left(\frac{r}{2}\right)^{2\nu}$$

$$= B_{z0}(z) - \frac{B''_{z0}(z)}{4}r^2 + \frac{B_{z0}^{(4)}(z)}{64}r^4 - \frac{B_{z0}^{(6)}(z)}{2304}r^6 + \frac{B_{z0}^{(8)}(z)}{147456}r^8 + \dots$$

$B_{z0}(z) \equiv B_z^a(r=0, z) =$ On-axis Field

⋯

Linear Terms

$$B_{z0}^{(n)}(z) \equiv \frac{\partial^n B_{z0}(z)}{\partial z^n} \quad B'_{z0}(z) \equiv \frac{\partial B_{z0}(z)}{\partial z} \quad B''_{z0}(z) \equiv \frac{\partial^2 B_{z0}(z)}{\partial z^2}$$

For modeling, we truncate the expansion using only leading-order terms to obtain:

- Corresponds to **linear dynamics** in the equations of motion

$$\begin{aligned} B_x^a &= -\frac{1}{2} \frac{\partial B_{z0}(z)}{\partial z} x \\ B_y^a &= -\frac{1}{2} \frac{\partial B_{z0}(z)}{\partial z} y & B_{z0}(z) &\equiv B_z^a(\mathbf{x}_\perp = 0, z) \\ B_z^a &= B_{z0}(z) & &= \text{On-Axis Field} \end{aligned}$$

Note that this truncated expansion is **divergence free**:

$$\nabla \cdot \mathbf{B}^a = -\frac{1}{2} \frac{\partial B_{z0}}{\partial z} \frac{\partial}{\partial \mathbf{x}_\perp} \cdot \mathbf{x}_\perp + \frac{\partial}{\partial z} B_{z0} = 0$$

but not curl free within the vacuum aperture:

$$\begin{aligned} \nabla \times \mathbf{B}^a &= \frac{1}{2} \frac{\partial^2 B_{z0}(z)}{\partial z^2} (-\hat{\mathbf{x}}y + \hat{\mathbf{y}}x) \\ &= \frac{1}{2} \frac{\partial^2 B_{z0}(z)}{\partial z^2} r(-\hat{\mathbf{x}} \sin \theta + \hat{\mathbf{y}} \cos \theta) = \frac{1}{2} \frac{\partial^2 B_{z0}(z)}{\partial z^2} r \hat{\theta} \end{aligned}$$

- Nonlinear terms needed to satisfy 3D Maxwell equations

Solenoid equations of motion:

- ◆ Insert field components into equations of motion and collect terms

$$x'' + \frac{(\gamma_b \beta_b)'}{(\gamma_b \beta_b)} x' - \frac{B'_{z0}(s)}{2[B\rho]} y - \frac{B_{z0}(s)}{[B\rho]} y' = -\frac{q}{m\gamma_b^3 \beta_b^2 c^2} \frac{\partial \phi}{\partial x}$$

$$y'' + \frac{(\gamma_b \beta_b)'}{(\gamma_b \beta_b)} y' + \frac{B'_{z0}(s)}{2[B\rho]} x + \frac{B_{z0}(s)}{[B\rho]} x' = -\frac{q}{m\gamma_b^3 \beta_b^2 c^2} \frac{\partial \phi}{\partial y}$$

$$[B\rho] \equiv \frac{\gamma_b \beta_b m c}{q} = \text{Rigidity} \qquad \frac{B_{z0}(s)}{[B\rho]} = \frac{\omega_c(s)}{\gamma_b \beta_b c}$$

$$\omega_c(s) = \frac{q B_{z0}(s)}{m} = \text{Cyclotron Frequency} \\ \text{(in applied axial magnetic field)}$$

- ◆ Equations are linearly **cross-coupled** in the applied field terms
 - x equation depends on y, y'
 - y equation depends on x, x'

It can be shown (see: **Appendix B**) that the linear cross-coupling in the applied field can be removed by an s -varying transformation to a rotating “Larmor” frame:

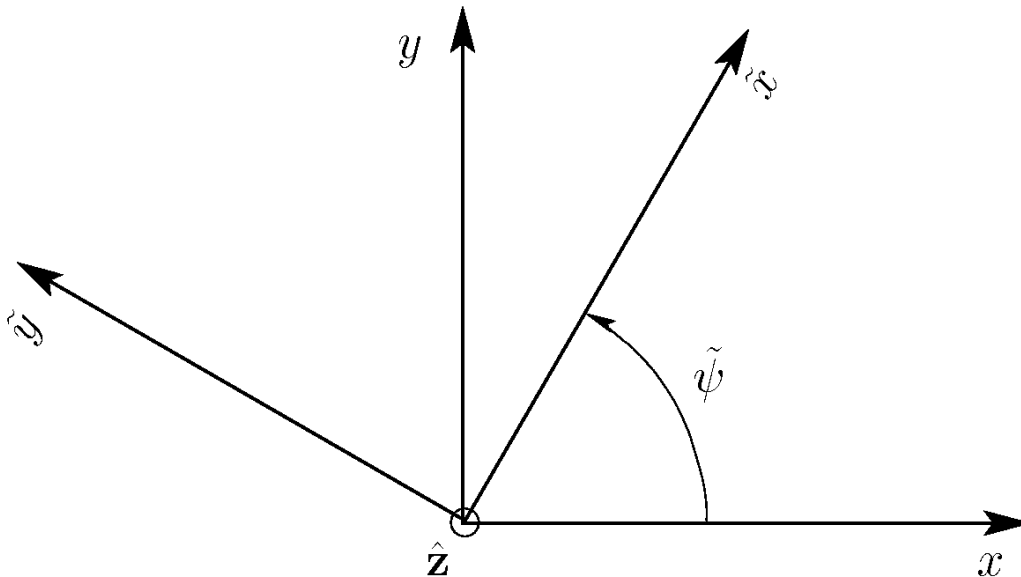

$$\tilde{x} = x \cos \tilde{\psi}(s) + y \sin \tilde{\psi}(s)$$

$$\tilde{y} = -x \sin \tilde{\psi}(s) + y \cos \tilde{\psi}(s)$$

$$\tilde{\psi}(s) = - \int_{s_i}^s d\bar{s} k_L(\bar{s})$$

$$k_L(s) \equiv \frac{B_{z0}(s)}{2[B\rho]} = \frac{\omega_c(s)}{2\gamma_b\beta_b c}$$

= Larmor
wave number

$s = s_i$ defines
initial condition

$\tilde{\dots}$ used to denote
rotating frame variables

If the beam space-charge is *axisymmetric*:

$$\frac{\partial \phi}{\partial \mathbf{x}_\perp} = \frac{\partial \phi}{\partial r} \frac{\partial r}{\partial \mathbf{x}_\perp} = \frac{\partial \phi}{\partial r} \frac{\mathbf{x}_\perp}{r}$$

then the space-charge term also decouples under the **Larmor transformation** and the equations of motion can be expressed in fully **uncoupled form**:

$$\tilde{x}'' + \frac{(\gamma_b \beta_b)'}{(\gamma_b \beta_b)} \tilde{x}' + \kappa(s) \tilde{x} = - \frac{q}{m \gamma_b^3 \beta_b^2 c^2} \frac{\partial \phi}{\partial r} \frac{\tilde{x}}{r}$$

$$\tilde{y}'' + \frac{(\gamma_b \beta_b)'}{(\gamma_b \beta_b)} \tilde{y}' + \kappa(s) \tilde{y} = - \frac{q}{m \gamma_b^3 \beta_b^2 c^2} \frac{\partial \phi}{\partial r} \frac{\tilde{y}}{r}$$

$$\kappa(s) = k_L^2(s) \equiv \left[\frac{B_{z0}(s)}{2[B\rho]} \right]^2 = \left[\frac{\omega_c(s)}{2\gamma_b \beta_b c} \right]^2$$

Will demonstrate this in problems for the simple case of:

$$B_{z0}(s) = \text{const}$$

- Because Larmor frame equations are in the same form as continuous and quadrupole focusing with a different κ , for solenoidal focusing we implicitly work in the Larmor frame and simplify notation by dropping the tildes:

$$\tilde{\mathbf{X}}_\perp \rightarrow \mathbf{X}_\perp$$

/// Aside: Notation:

A common theme of this class will be to introduce new effects and generalizations while keeping formulations looking **as similar as possible** to the the most simple representations given. When doing so, we will often use “tildes” to denote transformed variables to stress that the new coordinates have, in fact, a more complicated form that must be interpreted in the context of the analysis being carried out. Some examples:

- ◆ Larmor frame transformations for Solenoidal focusing
See: **Appendix B**
- ◆ Normalized variables for analysis of accelerating systems
See: **S10**
- ◆ Coordinates expressed relative to the beam centroid
See: S.M. Lund, lectures on **Transverse Centroid and Envelope Model**
- ◆ Variables used to analyze Einzel lenses
See: J.J. Barnard, **Introductory Lectures**

///

Solenoid periodic lattices can be formed similarly to the quadrupole case

- ◆ Drifts placed between solenoids of finite axial length
 - Allows space for diagnostics, pumping, acceleration cells, etc.
- ◆ Analogous equivalence cases to quadrupole
 - Piecewise constant κ often used
- ◆ Fringe can be more important for solenoids

Simple hard-edge solenoid lattice with piecewise constant κ

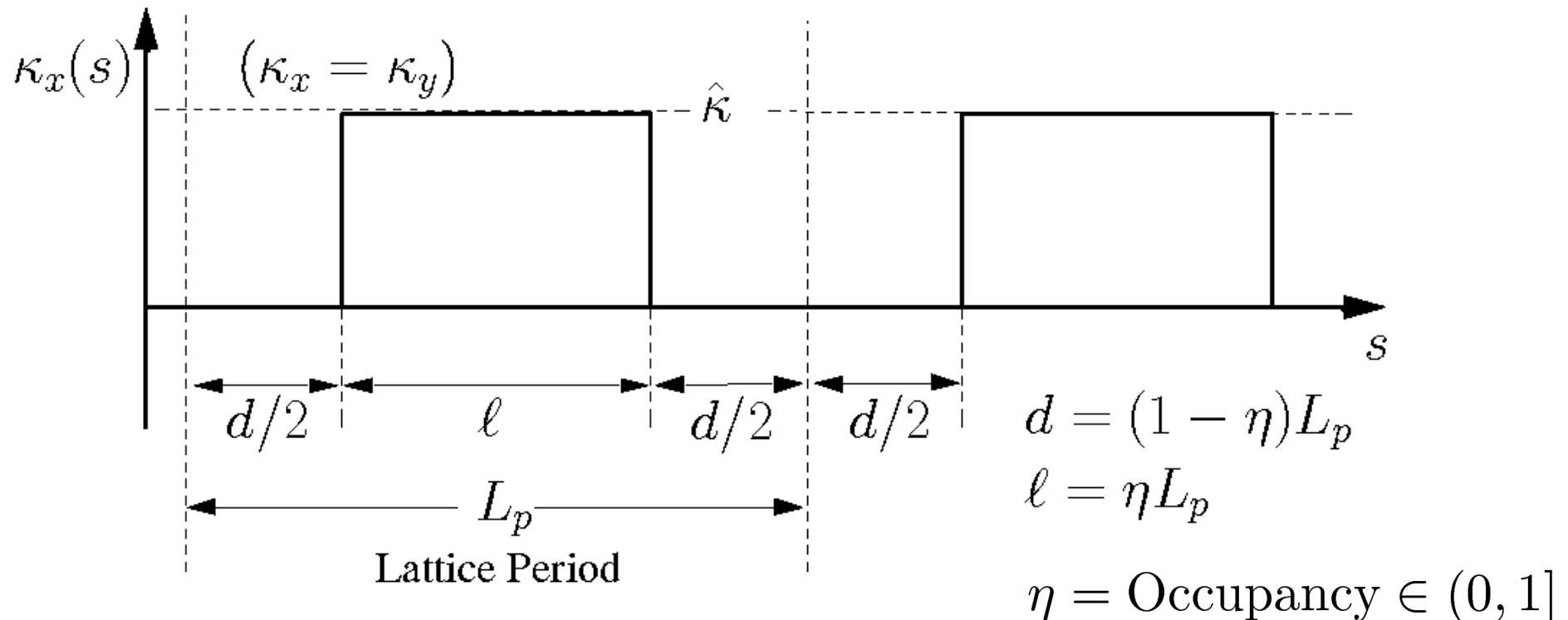

/// Example: Larmor Frame Particle Orbits in a Periodic Solenoidal Focusing

Lattice: $\tilde{x} - \tilde{x}'$ phase-space for hard edge elements and applied fields

$$L_p = 0.5 \text{ m} \quad \kappa = 20 \text{ rad/m}^2 \text{ in Solenoids} \quad \tilde{x}(0) = 1 \text{ mm} \quad \tilde{y}(0) = 0$$

$$\eta = 0.5 \quad \phi \simeq 0 \quad \gamma_b \beta_b = \text{const} \quad \tilde{x}'(0) = 0 \quad \tilde{y}'(0) = 0$$

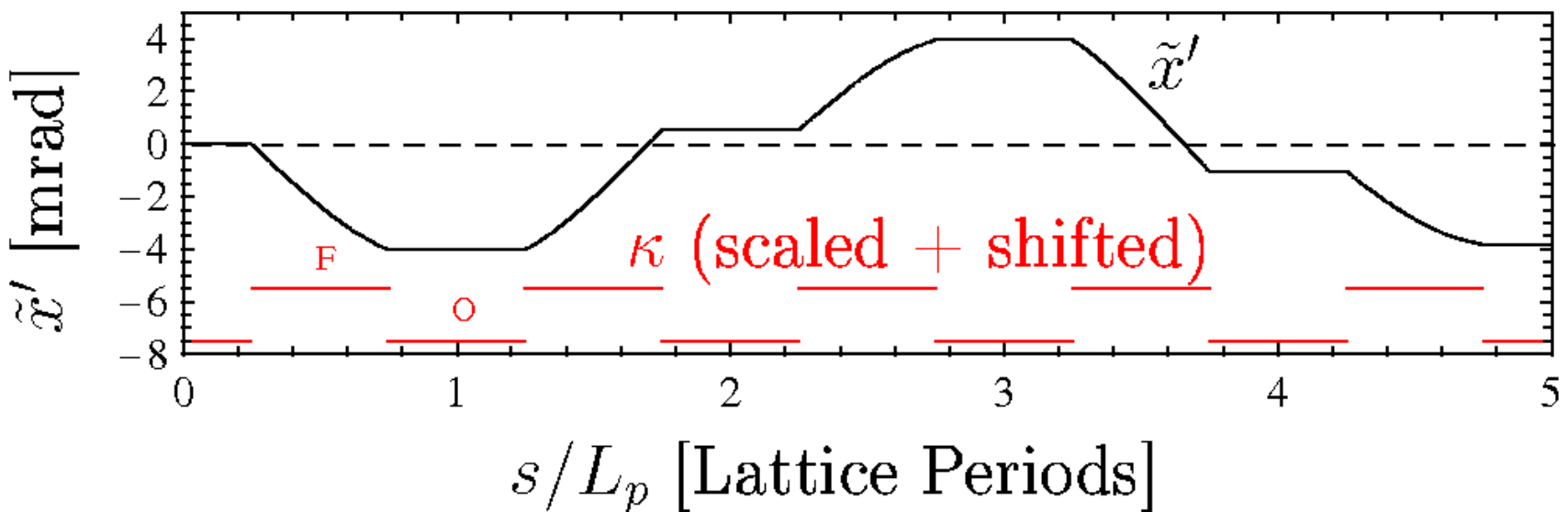
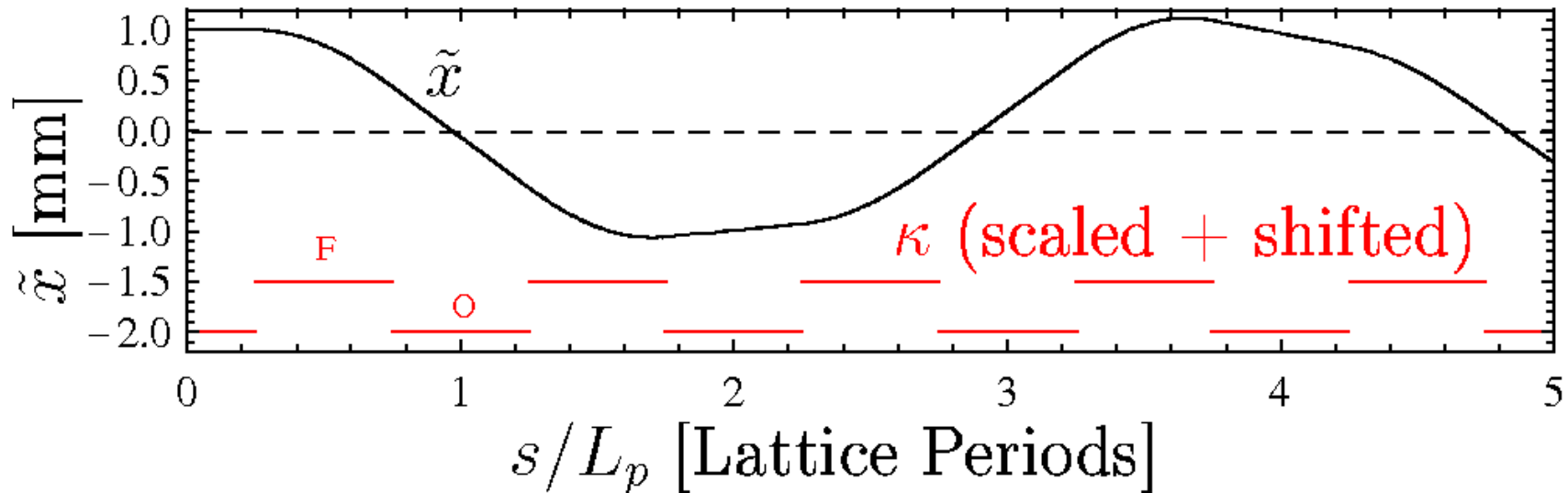

Contrast of Larmor-Frame and Lab-Frame Orbits

- ◆ Same initial condition

Larmor-Frame Coordinate Orbit in transformed x -plane only

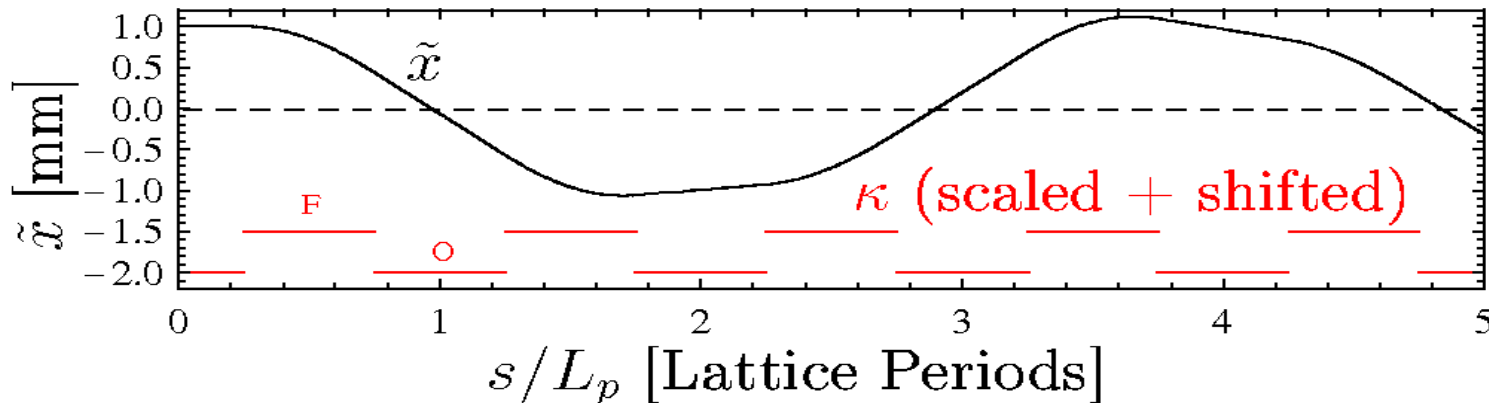

Lab-Frame Coordinate Orbit in both x - and y -planes

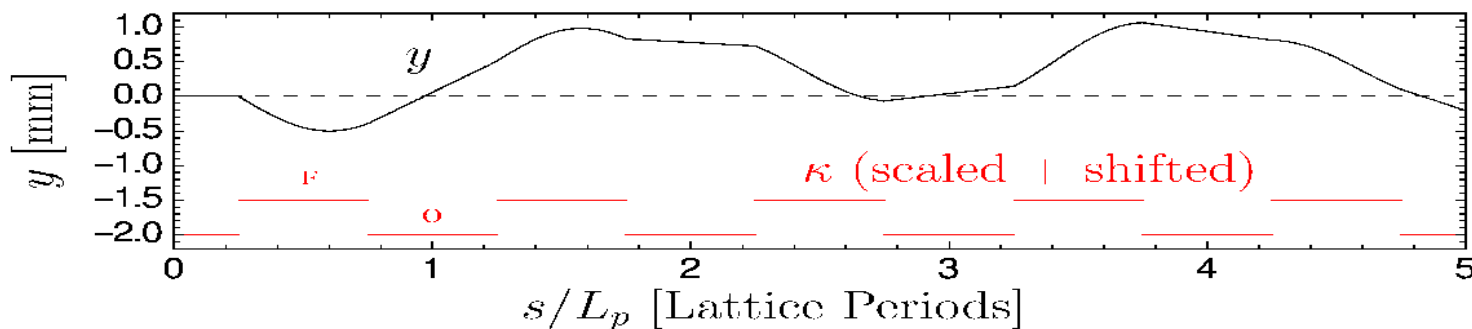
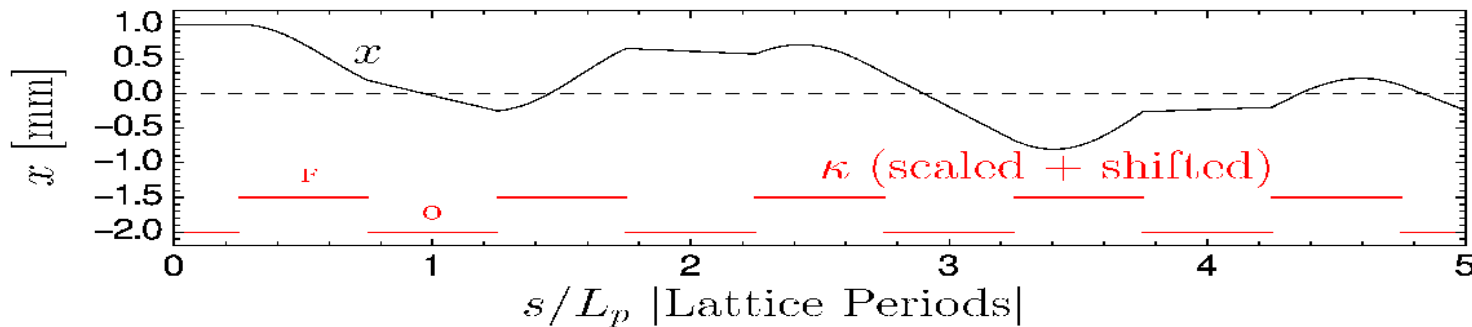

Calculate using transfer matrices in **Appendix C**

Contrast of Larmor-Frame and Lab-Frame Orbits

- ◆ Same initial condition

Larmor-Frame Angle

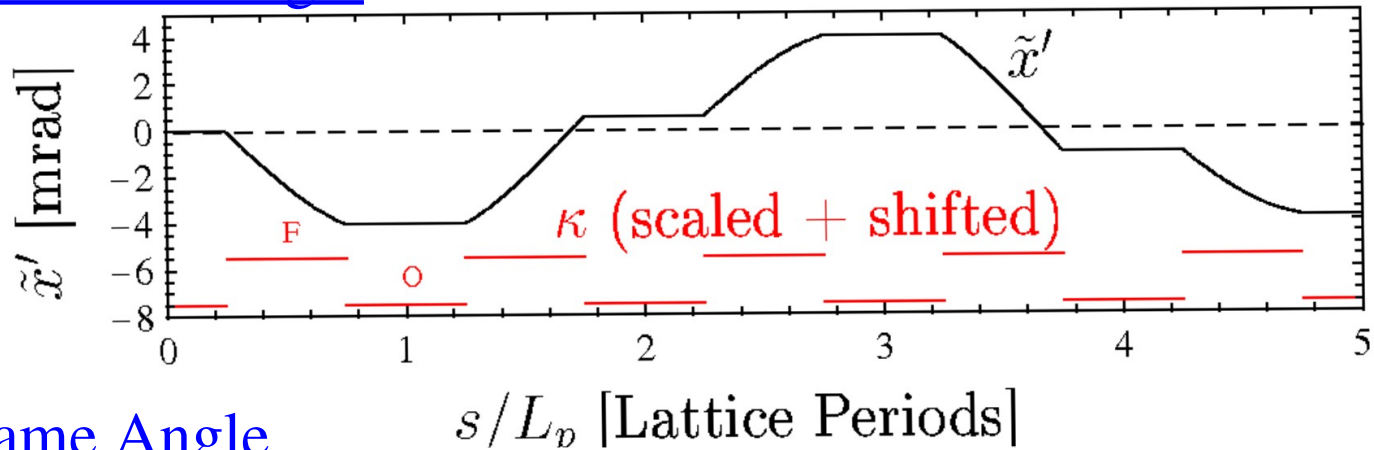

Lab-Frame Angle

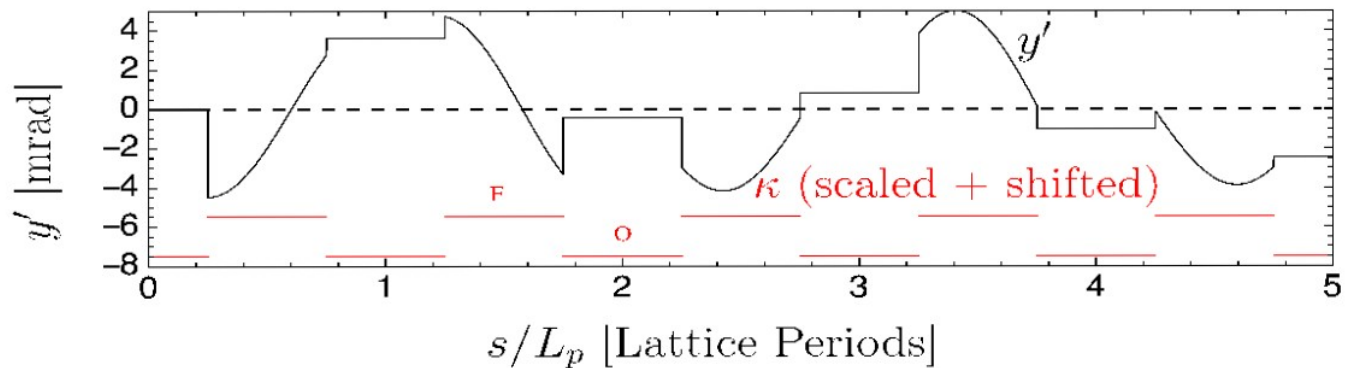
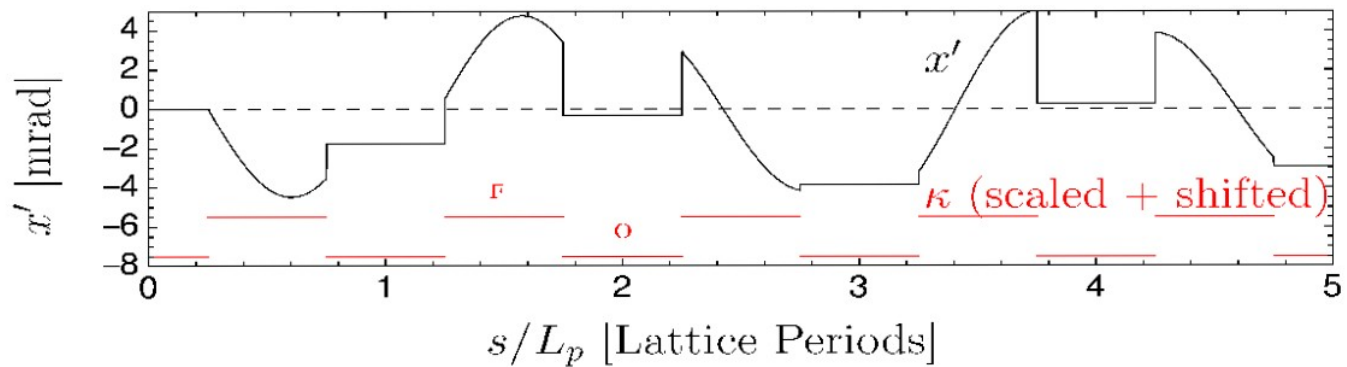

Calculate
using
transfer
matrices in
Appendix C

Additional perspectives of particle orbit in solenoid transport channel

- ◆ Same initial condition

Radius evolution (Lab or Larmor Frame: radius same)

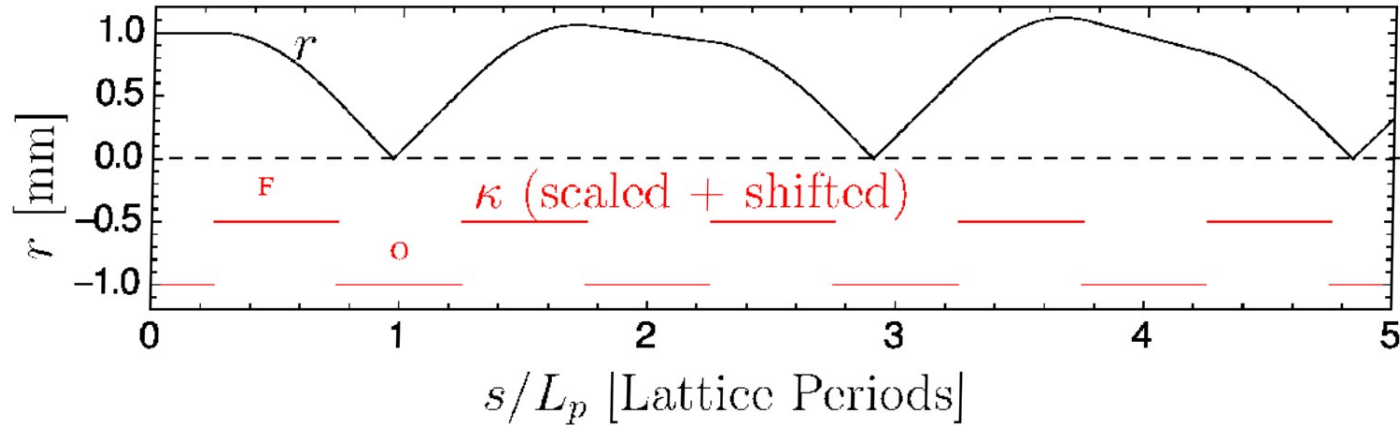

Side- (2 view points) and End-View Projections of 3D Lab-Frame Orbit

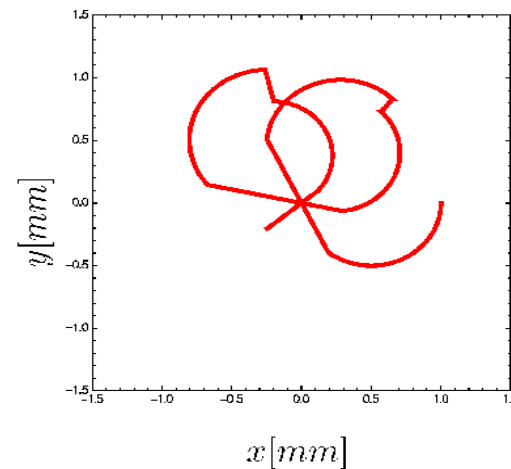
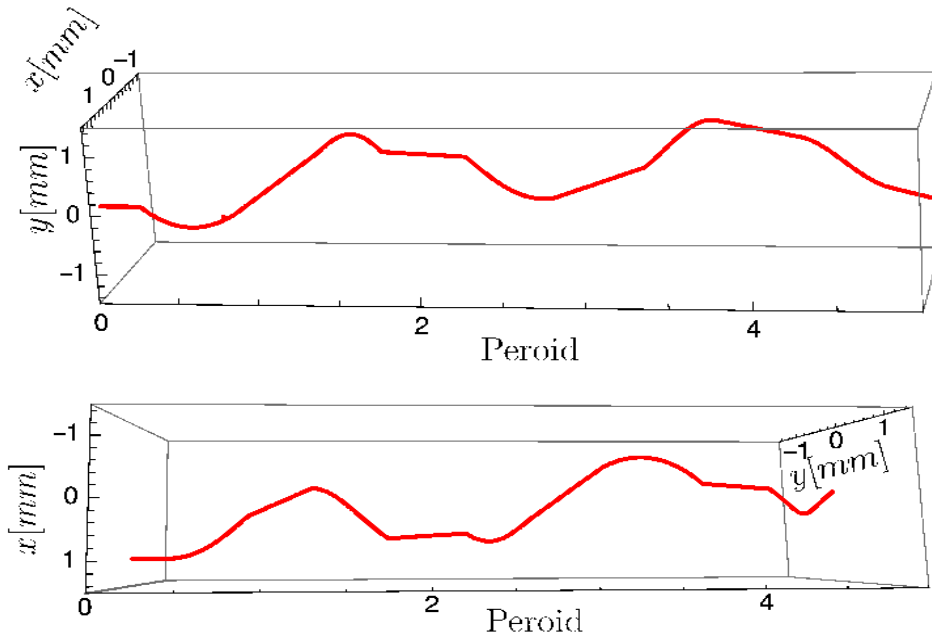

Calculate
using
transfer
matrices in
Appendix C

Larmor angle and angular momentum of particle orbit in solenoid transport channel

◆ Same initial condition

Larmor Angle

$$\tilde{\psi}(s) = - \int_{s_i}^s d\bar{s} k_L(\bar{s}) \quad k_L(s) \equiv \frac{B_{z0}(s)}{2[B\rho]}$$

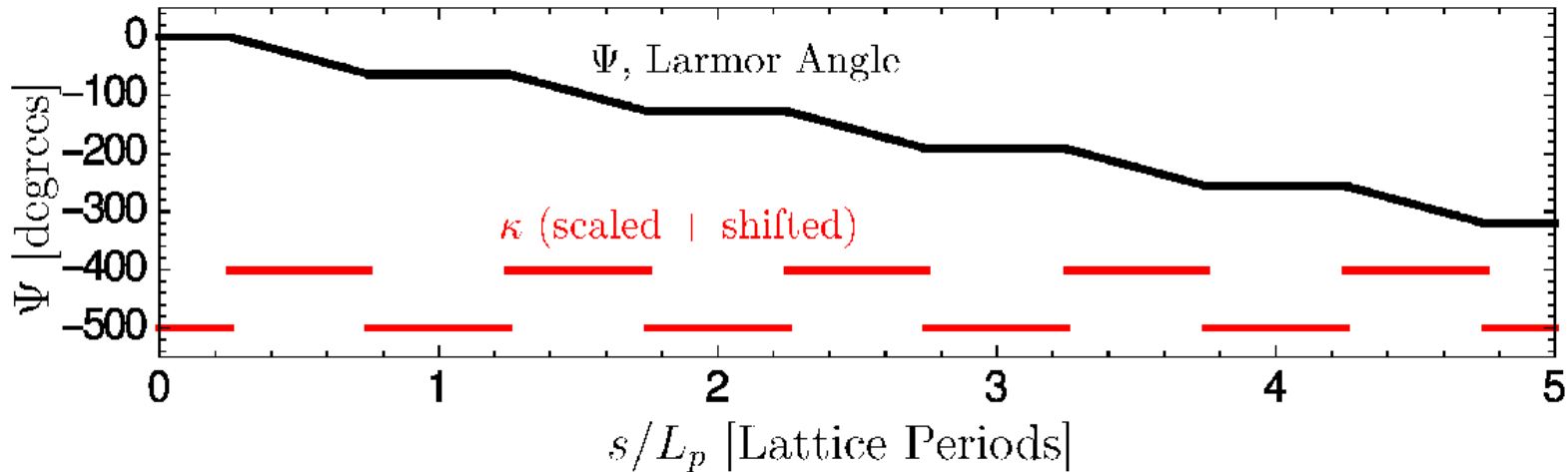

Angular Momentum and Canonical Angular Momentum (see Sec. S2G)

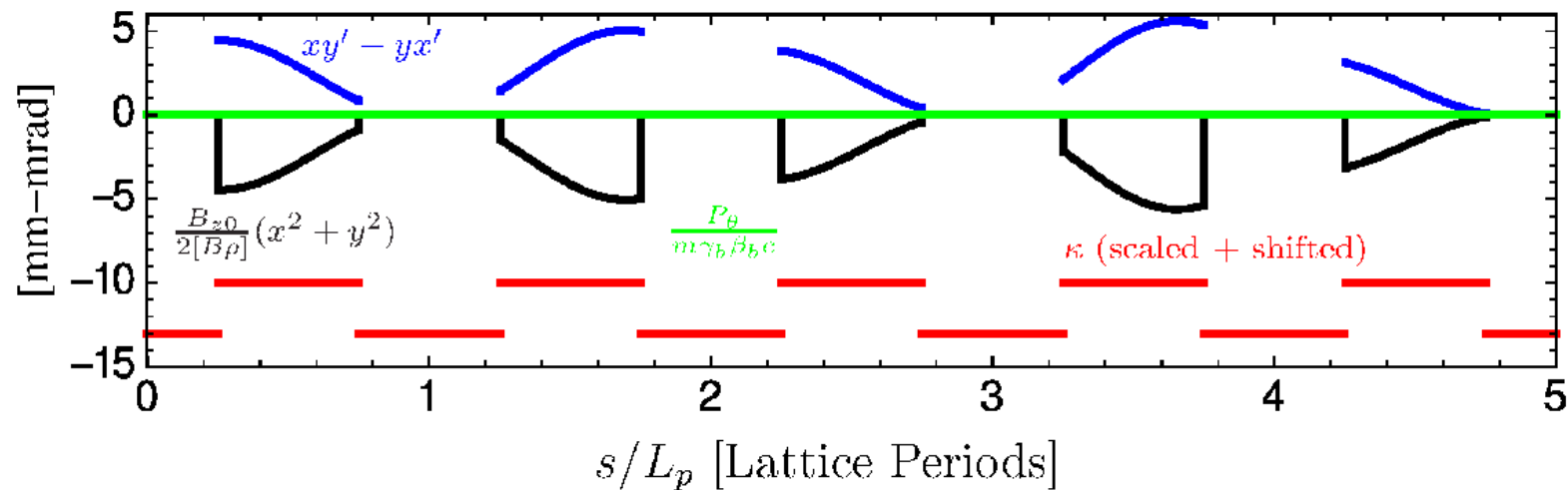

///

Comments on Orbits:

- ◆ See [Appendix C](#) for details on calculation
 - Discontinuous fringe of hard-edge model must be treated carefully if integrating in the laboratory-frame.
- ◆ Larmor-frame orbits strongly deviate from simple harmonic form due to periodic focusing
 - Multiple harmonics present
 - Less complicated than quadrupole AG focusing case when interpreted in the Larmor frame due to the optic being focusing in both planes
- ◆ Orbits transformed back into the Laboratory frame using Larmor transform (see: [Appendix B](#) and [Appendix C](#))
 - Laboratory frame orbit exhibits more complicated x - y plane coupled oscillatory structure
- ◆ Will find later that if the focusing is sufficiently strong, the orbit can become unstable (see: [S5](#))
- ◆ Larmor frame y -orbits have same properties as the x -orbits due to the equations being decoupled and identical in form in each plane
 - In example, Larmor y -orbit is zero due to simple initial condition in x -plane
 - Lab y -orbit is nonzero due to x - y coupling

Comments on Orbits (continued):

- ◆ Larmor angle advances continuously even for hard-edge focusing
- ◆ Mechanical angular momentum jumps discontinuously going into and out of the solenoid
 - Particle spins up and down going into and out of the solenoid
 - No mechanical angular momentum outside of solenoid due to the choice of initial condition in this example (initial x -plane motion)
- ◆ Canonical angular momentum P_θ is conserved in the 3D orbit evolution
 - As expected from analysis in [S2G](#)
 - Invariance provides a good check on dynamics
 - P_θ in example has zero value due to the specific (x -plane) choice of initial condition. Other choices can give nonzero values and finite mechanical angular momentum in drifts.

Some properties of particle orbits in solenoids with piecewise $\kappa = \text{const}$ will be analyzed in the problem sets



S2F: Summary of Transverse Particle Equations of Motion

In linear applied focusing channels, without momentum spread or radiation, the particle equations of motion in both the x - and y -planes expressed as:

$$x'' + \frac{(\gamma_b \beta_b)'}{(\gamma_b \beta_b)} x' + \kappa_x(s)x = -\frac{q}{m\gamma_b^3 \beta_b^2 c^2} \frac{\partial}{\partial x} \phi$$
$$y'' + \frac{(\gamma_b \beta_b)'}{(\gamma_b \beta_b)} y' + \kappa_y(s)y = -\frac{q}{m\gamma_b^3 \beta_b^2 c^2} \frac{\partial}{\partial y} \phi$$

$\kappa_x(s)$ = x -focusing function of lattice

$\kappa_y(s)$ = y -focusing function of lattice

Common focusing functions:

Continuous:

$$\kappa_x(s) = \kappa_y(s) = k_{\beta 0}^2 = \text{const}$$

Quadrupole (Electric or Magnetic):

$$\kappa_x(s) = -\kappa_y(s) = \kappa(s)$$

Solenoidal (equations must be interpreted in Larmor Frame: see Appendix **B**):

$$\kappa_x(s) = \kappa_y(s) = \kappa(s)$$

Although the equations have the same form, the couplings to the fields are different which leads to different regimes of applicability for the various focusing technologies with their associated technology limits:

Focusing:

Continuous:

$$\kappa_x(s) = \kappa_y(s) = k_{\beta 0}^2 = \text{const}$$

Good qualitative guide (see later material/lecture)

BUT not physically realizable (see **S2B**)

Quadrupole:

$$\kappa_x(s) = -\kappa_y(s) = \begin{cases} \frac{G(s)}{\beta_b c [B\rho]}, & \text{Electric} \\ \frac{G(s)}{c [B\rho]}, & \text{Magnetic} \end{cases} \quad [B\rho] = \frac{m\gamma_b\beta_b c}{q}$$

G is the field gradient which for linear applied fields is:

$$G(s) = \begin{cases} -\frac{\partial E_x^a}{\partial x} = \frac{\partial E_y^a}{\partial y} = \frac{2V_q}{r_p^2}, & \text{Electric} \\ \frac{\partial B_x^a}{\partial y} = \frac{\partial B_y^a}{\partial x} = \frac{B_p}{r_p}, & \text{Magnetic} \end{cases}$$

Solenoid:

$$\kappa_x(s) = \kappa_y(s) = k_L^2(s) = \left[\frac{B_{z0}(s)}{2[B\rho]} \right]^2 = \left[\frac{\omega_c(s)}{2\gamma_b\beta_b c} \right]^2 \quad \omega_c(s) = \frac{qB_{z0}(s)}{m}$$

It is instructive to review the structure of solutions of the transverse particle equations of motion **in the absence of**:

Space-charge: $\frac{\partial\phi}{\partial x} \sim \frac{\partial\phi}{\partial y} \sim 0$

Acceleration: $\gamma_b\beta_b \simeq \text{const} \quad \Longrightarrow \quad \frac{(\gamma_b\beta_b)'}{(\gamma_b\beta_b)} \simeq 0$

In this simple limit, the x and y -equations are of the same **Hill's Equation** form:

$$x'' + \kappa_x(s)x = 0$$

$$y'' + \kappa_y(s)y = 0$$

- ◆ These equations are central to transverse dynamics in conventional accelerator physics (weak space-charge and acceleration)
 - Will study how solutions change with space-charge in later lectures

In many cases beam transport lattices are designed where the applied focusing functions are **periodic**:

$$\kappa_x(s + L_p) = \kappa_x(s)$$

$$\kappa_y(s + L_p) = \kappa_y(s)$$

$$L_p = \text{Lattice Period}$$

Common, simple examples of **periodic lattices**:

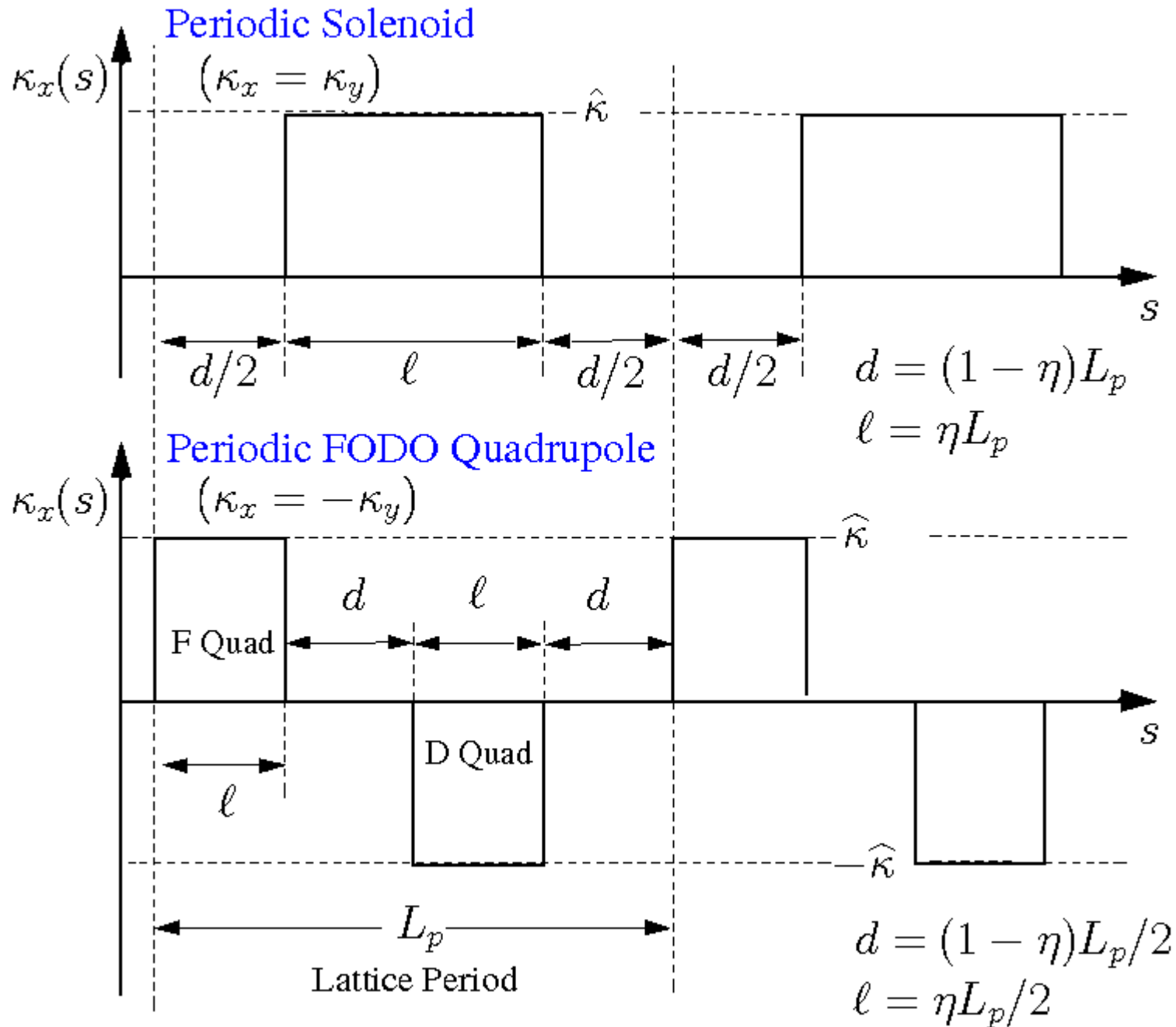

However, the focusing functions need not be periodic:

- ◆ Often take periodic or continuous in this class for simplicity of interpretation

Focusing functions can vary strongly in many common situations:

- ◆ Matching and transition sections
- ◆ Strong acceleration
- ◆ Significantly different elements can occur within periods of lattices in rings
 - “Panofsky” type (wide aperture along one plane) quadrupoles for beam insertion and extraction in a ring

Example of Non-Periodic Focusing Functions: Beam Matching Section

Maintains alternating-gradient structure but not quasi-periodic

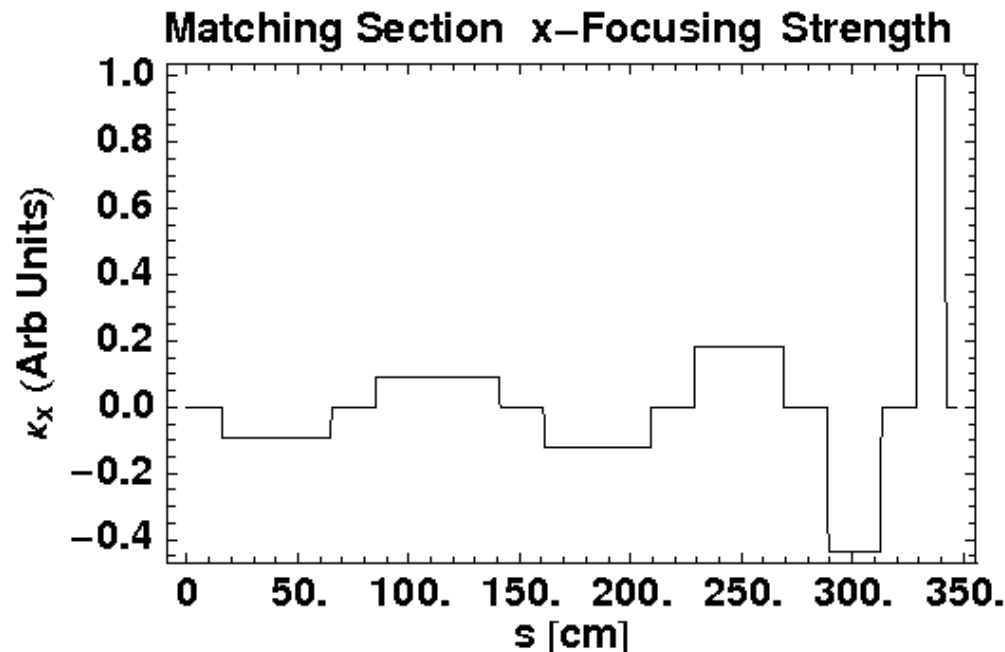

Example corresponds to High Current Experiment Matching Section (hard edge equivalent) at LBNL (2002)

Equations presented in this section apply to a single particle moving in a beam under the action of linear applied focusing forces. In the remaining sections, we will (mostly) neglect space-charge ($\phi \rightarrow 0$) as is conventional in the standard theory of low-intensity accelerators.

- ◆ What we learn from treatment will later aid analysis of space-charge effects
 - Appropriate variable substitutions will be made to apply results
- ◆ Important to understand basic applied field dynamics since space-charge complicates
 - Results in plasma-like collective response

/// **Example:** We will see in **Transverse Centroid and Envelope Descriptions of Beam Evolution** that the linear particle equations of motion can be applied to analyze the evolution of a beam when image charges are neglected

$$x \rightarrow x_c \equiv \langle x \rangle_{\perp} \quad x - \text{centroid}$$

$$y \rightarrow y_c \equiv \langle y \rangle_{\perp} \quad y - \text{centroid}$$

///

S2G: Conservation of Angular Momentum in Axisymmetric Focusing Systems

Background:

Goal: find an invariant for axisymmetric focusing systems which can help us further interpret/understand the dynamics.

In Hamiltonian descriptions of beam dynamics one must employ proper canonical conjugate variables such as (x -plane):

$$\begin{array}{ll} x = & \text{Canonical Coordinate} \\ P_x = p_x + qA_x = & \text{Canonical Momentum} \end{array} \quad \begin{array}{l} + \text{analogous} \\ y\text{-plane} \end{array}$$

Here, \mathbf{A} denotes the vector potential of the (static for cases of field models considered here) applied magnetic field with:

$$\mathbf{B}^a = \nabla \times \mathbf{A}$$

For the cases of linear applied magnetic fields in this section, we have:

$$\mathbf{A} = \begin{cases} \hat{\mathbf{z}} \frac{G}{2} (y^2 - x^2), & \text{Magnetic Quadrupole Focusing} \\ -\hat{\mathbf{x}} \frac{1}{2} B_{z0} y + \hat{\mathbf{y}} \frac{1}{2} B_{z0} x, & \text{Solenoidal Focusing} \\ 0, & \text{Otherwise} \end{cases}$$

For continuous, electric or magnetic quadrupole focusing without acceleration ($\gamma_b \beta_b = \text{const}$), it is straightforward to verify that x, x' and y, y' are canonical coordinates and that the correct equations of motion are generated by the Hamiltonian:

$$H_{\perp} = \frac{1}{2}x'^2 + \frac{1}{2}y'^2 + \frac{1}{2}\kappa_x x^2 + \frac{1}{2}\kappa_y y^2 + \frac{q\phi}{m\gamma_b^3\beta_b^2 c^3}$$

$$\frac{d}{ds}x = \frac{\partial H_{\perp}}{\partial x'} \qquad \frac{d}{ds}x = \frac{\partial H_{\perp}}{\partial y'}$$

$$\frac{d}{ds}x' = -\frac{\partial H_{\perp}}{\partial x} \qquad \frac{d}{ds}y' = -\frac{\partial H_{\perp}}{\partial y}$$

Giving the familiar equations of motion:

$$x'' + \kappa_x x = -\frac{q}{m\gamma_b^3\beta_b^2 c^2} \frac{\partial \phi}{\partial x}$$

$$y'' + \kappa_y y = -\frac{q}{m\gamma_b^3\beta_b^2 c^2} \frac{\partial \phi}{\partial y}$$

For solenoidal magnetic focusing without acceleration, it can be verified that we can take (tilde) canonical variables:

- ◆ Tildes *do not* denote Larmor transform variables here !

$$\begin{aligned} \tilde{x} &= x & \tilde{y} &= y \\ \tilde{x}' &= x' - \frac{B_{z0}}{2[B\rho]}y & \tilde{y}' &= y' + \frac{B_{z0}}{2[B\rho]}x \end{aligned} \quad [B\rho] \equiv \frac{m\gamma_b\beta_b c}{q}$$

With Hamiltonian:

$$\tilde{H}_\perp = \frac{1}{2} \left[\left(\tilde{x}' + \frac{B_{z0}}{2[B\rho]} \tilde{y} \right)^2 + \left(\tilde{y}' - \frac{B_{z0}}{2[B\rho]} \tilde{x} \right)^2 \right] + \frac{q\phi}{m\gamma_b^3\beta_b^2 c^3}$$

$$\begin{aligned} \frac{d}{ds} \tilde{x} &= \frac{\partial \tilde{H}_\perp}{\partial \tilde{x}'} & \frac{d}{ds} \tilde{y} &= \frac{\partial \tilde{H}_\perp}{\partial \tilde{y}'} & \text{Caution:} \\ \frac{d}{ds} \tilde{x}' &= -\frac{\partial \tilde{H}_\perp}{\partial \tilde{x}} & \frac{d}{ds} \tilde{y}' &= -\frac{\partial \tilde{H}_\perp}{\partial \tilde{y}} & \text{Primes do not mean } d/ds \text{ in} \\ & & & & \text{tilde variables here: just} \\ & & & & \text{notation to distinguish} \\ & & & & \text{“momentum” variable!} \end{aligned}$$

Giving (after some algebra) the familiar equations of motion:

$$\begin{aligned} x'' - \frac{B'_{z0}(s)}{2[B\rho]}y - \frac{B_{z0}(s)}{[B\rho]}y' &= -\frac{q}{m\gamma_b^3\beta_b^2 c^2} \frac{\partial \phi}{\partial x} \\ y'' + \frac{B'_{z0}(s)}{2[B\rho]}x + \frac{B_{z0}(s)}{[B\rho]}x' &= -\frac{q}{m\gamma_b^3\beta_b^2 c^2} \frac{\partial \phi}{\partial y} \end{aligned}$$

Canonical angular momentum

One expects from general considerations (Noether's Theorem in dynamics) that systems with a symmetry have a conservation constraint associated with the generator of the symmetry. So for systems with azimuthal symmetry ($\partial/\partial\theta = 0$), one expects there to be a conserved canonical angular momentum (generator of rotations). Based on the Hamiltonian dynamics structure, examine:

$$P_\theta \equiv [\mathbf{x} \times \mathbf{P}] \cdot \hat{\mathbf{z}} = [\mathbf{x} \times (\mathbf{p} + q\mathbf{A})] \cdot \hat{\mathbf{z}}$$

This is exactly equivalent to

- Here γ factor is exact (*not* paraxial)

$$\begin{aligned} P_\theta &= (xp_y - yp_x) + q(xA_y - yA_x) \\ &= r(p_\theta + qA_\theta) = m\gamma r^2 \dot{\theta} + qrA_\theta \end{aligned}$$

Or employing the usual paraxial approximation steps:

$$\begin{aligned} P_\theta &\simeq m\gamma_b\beta_b c(xy' - yx') + q(xA_y - yA_x) \\ &= m\gamma_b\beta_b cr^2\theta' + qrA_\theta \end{aligned}$$

Inserting the vector potential components consistent with linear approximation solenoid focusing in the paraxial expression gives:

- ◆ Applies to (superimposed or separately) to continuous, magnetic or electric quadrupole, or solenoidal focusing since $A_\theta \neq 0$ only for solenoidal focusing

$$\begin{aligned}
 P_\theta &\simeq m\gamma_b\beta_b c(xy' - yx') + \frac{qB_{z0}}{2}(x^2 + y^2) \\
 &= m\gamma_b\beta_b cr^2\theta' + \frac{qB_{z0}}{2}r^2
 \end{aligned}$$

For a coasting beam ($\gamma_b\beta_b = \text{const}$), it is often convenient to analyze:

- ◆ Later we will find this is analogous to use of “unnormalized” variables used in calculation of ordinary emittance rather than normalized emittance

$$\begin{aligned}
 \frac{P_\theta}{m\gamma_b\beta_b c} &= xy' - yx' + \frac{B_{z0}}{2[B\rho]}(x^2 + y^2) & [B\rho] &\equiv \frac{m\gamma_b\beta_b c}{q} \\
 &= r^2\theta' + \frac{B_{z0}}{2[B\rho]}r^2
 \end{aligned}$$

Conservation of canonical angular momentum

To investigate situations where the canonical angular momentum is a constant of the motion for a beam evolving in linear applied fields, we differentiate P_θ with respect to s and apply equations of motion

Equations of Motion:

Including acceleration effects again, we summarize the equations of motion as:

- ◆ Applies to continuous, quadrupole (electric + magnetic), and solenoid focusing as expressed
- ◆ Several types of focusing can also be superimposed
 - Show for superimposed solenoid

$$\begin{aligned}
 x'' + \frac{(\gamma_b \beta_b)'}{(\gamma_b \beta_b)} x' + \kappa_x x - \frac{B'_{z0}(s)}{2[B\rho]} y - \frac{B_{z0}(s)}{[B\rho]} y' &= -\frac{q}{m\gamma_b^3 \beta_b^2 c^2} \frac{\partial \phi}{\partial x} \\
 y'' + \frac{(\gamma_b \beta_b)'}{(\gamma_b \beta_b)} y' + \kappa_y y + \frac{B'_{z0}(s)}{2[B\rho]} x + \frac{B_{z0}(s)}{[B\rho]} x' &= -\frac{q}{m\gamma_b^3 \beta_b^2 c^2} \frac{\partial \phi}{\partial y}
 \end{aligned}$$

$$[B\rho] = \frac{m\gamma_b \beta_b c}{q} \quad \kappa_x(s) = \begin{cases} k_{\beta 0}^2 = \text{const}, & \text{Continuous Focus } (\kappa_y = \kappa_x) \\ \frac{G(s)}{\beta_b c [B\rho]}, & \text{Electric Quadrupole Focus } (\kappa_y = -\kappa_x) \\ \frac{G(s)}{c [B\rho]}, & \text{Magnetic Quadrupole Focus } (\kappa_y = -\kappa_x) \end{cases}$$

Employ the paraxial form of P_θ consistent with the possible existence of a solenoid magnetic field:

- ◆ Formula also applies as expressed to continuous and quadrupole focusing

$$P_\theta = m\gamma_b\beta_b c(xy' - yx') + \frac{qB_{z0}}{2}(x^2 + y^2)$$

Differentiate and apply equations of motion:

- ◆ Intermediate algebraic steps not shown

$$\begin{aligned} \frac{d}{ds}P_\theta &= mc(\gamma_b\beta_b)'(xy' - yx') + mc(\gamma_b\beta_b)(xy'' - yx'') \\ &+ \frac{qB'_{z0}}{2}(x^2 + y^2) + qB_{z0}(xx' + yy') \\ &= mc(\gamma_b\beta_b)[\kappa_x - \kappa_y]xy - \frac{q}{\gamma_b^2\beta_b c} \left(x \frac{\partial\phi}{\partial y} - y \frac{\partial\phi}{\partial x} \right) \end{aligned}$$

So IF:

$$1) \kappa_x = \kappa_y$$

- ◆ Valid continuous or solenoid focusing
- ◆ Invalid for quadrupole focusing

$$2) x \frac{\partial\phi}{\partial y} - y \frac{\partial\phi}{\partial x} = \frac{\partial\phi}{\partial\theta} = 0$$

- ◆ Axisymmetric beam

$$\frac{d}{ds}P_\theta = 0 \quad \implies \quad P_\theta = \text{const}$$

For:

- ◆ Continuous focusing
- ◆ Linear optics solenoid magnetic focusing
- ◆ Other axisymmetric electric optics not covered such as Einzel lenses ...

$$P_\theta = m\gamma_b\beta_b c(xy' - yx') + \frac{qB_{z0}}{2}(x^2 + y^2) = \text{const}$$

$m\gamma_b\beta_b c(xy' - yx')$ = Mechanical Angular Momentum Term

$\frac{qB_{z0}}{2}(x^2 + y^2)$ = Vector Potential Angular Momentum Term

In [S2E](#) we plot for solenoidal focusing :

- ◆ Mechanical angular momentum $\propto xy' - yx'$
- ◆ Larmor rotation angle $\tilde{\psi}$
- ◆ Canonical angular momentum (constant) P_θ

Comments:

- ◆ Where valid, $P_\theta = \text{const}$ provides a powerful constraint to check dynamics
- ◆ If $P_\theta = \text{const}$ for all particles, then $\langle P_\theta \rangle = \text{const}$ for the beam as a whole and it is found in envelope models that canonical angular momentum can effectively act phase-space area (emittance-like term) defocusing the beam
- ◆ Valid for acceleration: similar to a “normalized emittance”: see [S10](#)

Example: solenoidal focusing channel

Employ the solenoid focusing channel example in [S2E](#) and plot:

- ◆ Mechanical angular momentum $\propto xy' - yx'$
- ◆ Vector potential contribution to canonical angular momentum $\propto B_{z0}(x^2 + y^2)$
- ◆ Canonical angular momentum (constant) P_θ

— $\frac{P_\theta}{m\gamma_b\beta_b c} = xy' - yx' + \frac{B_{z0}}{2[B\rho]}(x^2 + y^2) = \text{const} = \text{Canonical Angular Momentum}$

— $xy' - yx' = r^2\theta' = \text{Mechanical Angular Momentum}$

— $\frac{B_{z0}}{2[B\rho]}(x^2 + y^2) = \sqrt{\kappa}(x^2 + y^2) = \text{Vector Potential Component Canonical Angular Momentum}$

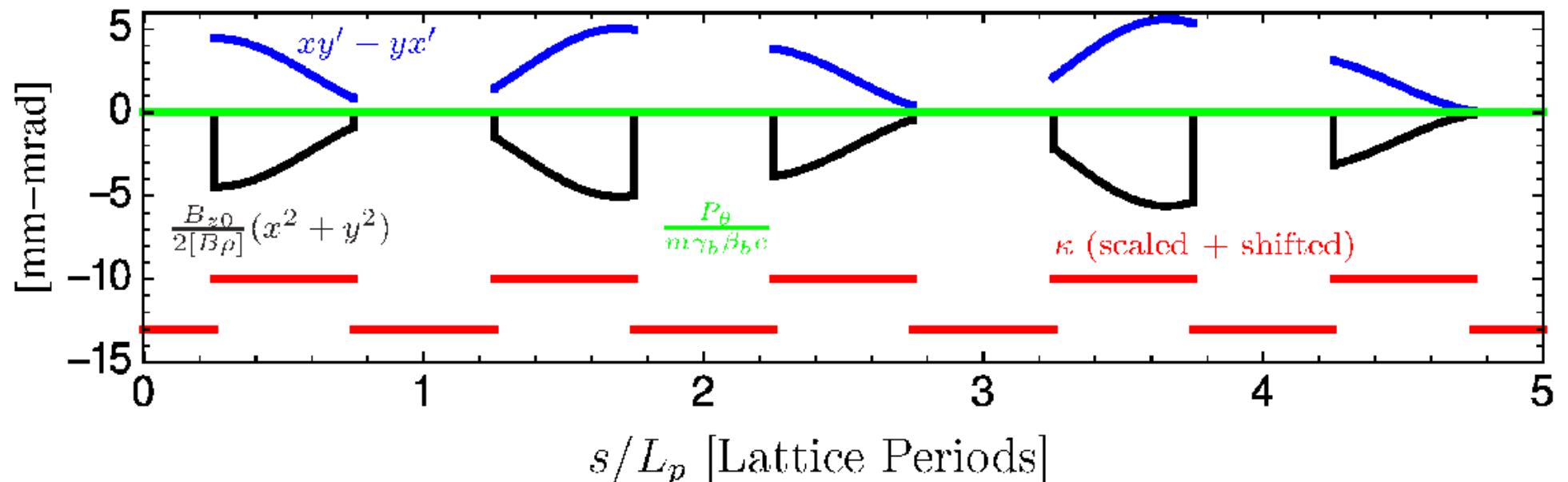

Comments on Orbits (see also info in S2E on 3D orbit):

- ◆ Mechanical angular momentum jumps discontinuously going into and out of the solenoid
 - Particle spins up (θ' jumps) and down going into and out of the solenoid
 - No mechanical angular momentum outside of solenoid due to the choice of initial condition in this example (initial x -plane motion)
- ◆ Canonical angular momentum P_θ is conserved in the 3D orbit evolution
 - Invariance provides a strong check on dynamics
 - P_θ in example has zero value due to the specific (x -plane) choice of initial condition of the particle. Other choices can give nonzero values and finite mechanical angular momentum in drifts.
- ◆ Solenoid provides focusing due to radial kicks associated with the “fringe” field entering the solenoid
 - Kick is abrupt for hard-edge solenoids
 - Details on radial kick/rotation structure can be found in [Appendix C](#)

Alternative expressions of canonical angular momentum

It is insightful to express the canonical angular momentum in (denoted tilde here) in the solenoid focusing canonical variables used earlier in this section and rotating Larmor frame variables:

- ◆ See [Appendix B](#) for Larmor frame transform
- ◆ Might expect simpler form of expressions given the relative simplicity of the formulation in canonical and Larmor frame variables

Canonical Variables:

$$\tilde{x} = x$$

$$\tilde{y} = y$$

$$\tilde{x}' = x' - \frac{B_{z0}}{2[B\rho]} y \quad \tilde{y}' = y' + \frac{B_{z0}}{2[B\rho]} x$$

$$\implies \frac{P_\theta}{m\gamma_b\beta_b c} \equiv xy' - yx' + \frac{B_{z0}}{2[B\rho]} (x^2 + y^2) \\ = \tilde{x}\tilde{y}' - \tilde{x}'\tilde{y}$$

- ◆ Applies to acceleration also since just employing transform as a definition here

Larmor (Rotating) Frame Variables:

Larmor transform following formulation in **Appendix B**:

◆ Here tildes denote Larmor frame variables

$$\begin{bmatrix} x \\ x' \\ y \\ y' \end{bmatrix} = \begin{bmatrix} \cos \tilde{\psi} & 0 & -\sin \tilde{\psi} & 0 \\ k_L \sin \tilde{\psi} & \cos \tilde{\psi} & k_L \cos \tilde{\psi} & -\sin \tilde{\psi} \\ \sin \tilde{\psi} & 0 & \cos \tilde{\psi} & 0 \\ -k_L \cos \tilde{\psi} & \sin \tilde{\psi} & k_L \sin \tilde{\psi} & \cos \tilde{\psi} \end{bmatrix} \begin{bmatrix} \tilde{x} \\ \tilde{x}' \\ \tilde{y} \\ \tilde{y}' \end{bmatrix} \quad \tilde{\psi}(s) = - \int_{s_i}^s d\bar{s} k_L(\bar{s})$$
$$k_L(s) \equiv \frac{B_{z0}(s)}{2[B\rho]}$$

gives after some algebra:

$$\implies x^2 + y^2 = \tilde{x}^2 + \tilde{y}^2$$

$$xy' - yx' = \tilde{x}\tilde{y}' - \tilde{y}\tilde{x}' - \frac{B_{z0}}{2[B\rho]}(\tilde{x}^2 + \tilde{y}^2)$$

Showing that:

$$\begin{aligned} \frac{P_\theta}{m\gamma_b\beta_b c} &\equiv xy' - yx' + \frac{B_{z0}}{2[B\rho]}(x^2 + y^2) \\ &= \tilde{x}\tilde{y}' - \tilde{y}\tilde{x}' \end{aligned}$$

- ◆ Same form as previous canonical variable case due to notation choices. However, steps/variables and implications different in this case !

Bush's Theorem expression of canonical angular momentum conservation

Take:

$$\mathbf{B}^a = \nabla \times \mathbf{A}$$

and apply Stokes Theorem to calculate the magnetic flux Ψ through a circle of radius r :

$$\Psi = \int_r d^2x \mathbf{B}^a \cdot \hat{\mathbf{z}} = \int_r d^2x (\nabla \times \mathbf{A}) \cdot \hat{\mathbf{z}} = \oint_r \mathbf{A} \cdot d\vec{\ell}$$

For a nonlinear, but axisymmetric solenoid, one can always take:

- ♦ Also applies to linear field component case

$$\mathbf{A} = \hat{\theta} A_\theta(r, z)$$

$$\implies \mathbf{B}^a = -\hat{\mathbf{r}} \frac{\partial A_\theta}{\partial z} + \hat{\mathbf{z}} \frac{1}{r} \frac{\partial}{\partial r} (r A_\theta)$$

Thus:

$$\Psi = 2\pi r A_\theta$$

// Aside: Nonlinear Application of Vector Potential

Given the magnetic field components

$$B_r^a(r, z) \quad B_z^a(r, z)$$

the equations

$$B_r^a(r, z) = -\frac{\partial}{\partial z} A_\theta(r, z)$$

$$B_z^a(r, z) = \frac{1}{r} \frac{\partial}{\partial r} [r A_\theta(r, z)]$$

can be integrated for a single isolated magnet to obtain *equivalent* expressions for A_θ

$$A_\theta(r, z) = -\int_{-\infty}^z d\tilde{z} B_r^a(r, \tilde{z})$$

$$A_\theta(r, z) = \frac{1}{r} \int_0^r d\tilde{r} \tilde{r} B_z^a(\tilde{r}, z)$$

- ◆ Resulting A_θ contains consistent nonlinear terms with magnetic field

//

Then the exact form of the canonical angular momentum for solenoid focusing can be expressed as:

- ◆ Here γ factor is exact (not paraxial)

$$\begin{aligned} P_\theta &= m\gamma r^2 \dot{\theta} + qr A_\theta \\ &= m\gamma r^2 \dot{\theta} + \frac{q\Psi}{2\pi} \end{aligned}$$

This form is often applied in solenoidal focusing and is known as “Bush's Theorem” with

$$P_\theta = m\gamma r^2 \dot{\theta} + \frac{q\Psi}{2\pi} = \text{const}$$

- ◆ In a static applied magnetic field, $\gamma = \text{const}$ further simplifying use of eqn
- ◆ Exact as expressed, but easily modified using familiar steps for paraxial form and/or linear field components
- ◆ Expresses how a particle “spins up” when entering a solenoidal magnetic field

Appendix A: Quadrupole Skew Coupling

Consider a quadrupole **actively rotated** through an angle ψ about the z-axis:

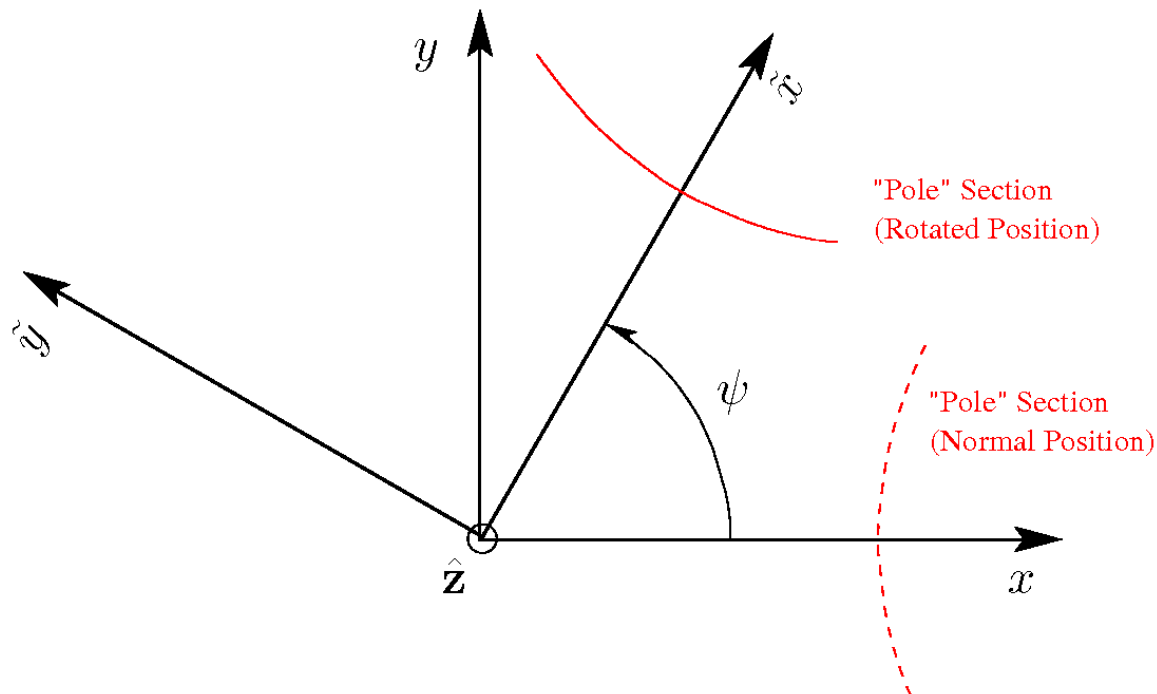

Transforms

$$\tilde{x} = x \cos \psi + y \sin \psi$$

$$\tilde{y} = -x \sin \psi + y \cos \psi$$

$$x = \tilde{x} \cos \psi - \tilde{y} \sin \psi$$

$$y = \tilde{x} \sin \psi + \tilde{y} \cos \psi$$

Normal Orientation Fields

Electric

$$E_x^a = -Gx$$

$$E_y^a = Gy$$

$$G = G(s)$$

= Field Gradient (Electric or Magnetic)

Magnetic

$$B_x^a = Gy$$

$$B_y^a = Gx$$

Note: units of G different in electric and magnetic cases

A1

Rotated Fields

Electric

$$\begin{aligned} E_x^a &= E_{\tilde{x}}^a \cos \psi - E_{\tilde{y}}^a \sin \psi & E_{\tilde{x}}^a &= -G\tilde{x} = -G(x \cos \psi + y \sin \psi) \\ E_y^a &= E_{\tilde{x}}^a \sin \psi + E_{\tilde{y}}^a \cos \psi & E_{\tilde{y}}^a &= G\tilde{y} = G(-x \sin \psi + y \cos \psi) \end{aligned}$$

Combine equations, collect terms, and apply trigonometric identities to obtain:

$$\begin{aligned} E_x^a &= -G \cos(2\psi)x - G \sin(2\psi)y & 2 \sin \psi \cos \psi &= \sin(2\psi) \\ E_y^a &= -G \sin(2\psi)x + G \cos(2\psi)y & \cos^2 \psi - \sin^2 \psi &= \cos(2\psi) \end{aligned}$$

Magnetic

$$\begin{aligned} B_x^a &= B_{\tilde{x}}^a \cos \psi - B_{\tilde{y}}^a \sin \psi & B_{\tilde{x}}^a &= G\tilde{y} = G(-x \sin \psi + y \cos \psi) \\ B_y^a &= B_{\tilde{x}}^a \sin \psi + B_{\tilde{y}}^a \cos \psi & B_{\tilde{y}}^a &= G\tilde{x} = G(x \cos \psi + y \sin \psi) \end{aligned}$$

Combine equations, collect terms, and apply trigonometric identities to obtain:

$$\begin{aligned} B_x^a &= -G \sin(2\psi)x + G \cos(2\psi)y \\ B_y^a &= G \cos(2\psi)x + G \sin(2\psi)y \end{aligned}$$

For *both* **electric** and **magnetic** focusing quadrupoles, these field component projections can be inserted in the linear field Eqns of motion to obtain:

Skew Coupled Quadrupole Equations of Motion

$$x'' + \frac{(\gamma_b \beta_b)'}{(\gamma_b \beta_b)} x' + \kappa \cos(2\psi)x + \kappa \sin(2\psi)y = -\frac{q}{m\gamma_b^3 \beta_b^2 c^2} \frac{\partial \phi}{\partial x}$$

$$y'' + \frac{(\gamma_b \beta_b)'}{(\gamma_b \beta_b)} y' - \kappa \cos(2\psi)y + \kappa \sin(2\psi)x = -\frac{q}{m\gamma_b^3 \beta_b^2 c^2} \frac{\partial \phi}{\partial y}$$

$$\kappa = \begin{cases} \frac{G}{\beta_b c [B\rho]}, & \text{Electric Focusing} \\ \frac{G}{[B\rho]}, & \text{Magnetic Focusing} \end{cases}$$

System is **skew coupled**:

- ◆ x -equation depends on y, y' and y -equation on x, x' for $\psi \neq n\pi/2$ (n integer)

Skew-coupling considerably complicates dynamics

- ◆ Unless otherwise specified, we consider only quadrupoles with “normal” orientation with $\psi = n\pi/2$
- ◆ Skew coupling errors or intentional skew couplings can be important
 - Leads to transfer of oscillations energy between x and y -planes
 - Invariants much more complicated to construct/interpret

The skew coupled equations of motion can be alternatively derived by actively rotating the quadrupole equation of motion in the form:

$$x'' + \frac{(\gamma_b \beta_b)'}{(\gamma_b \beta_b)} x' + \kappa(s)x = -\frac{q}{m\gamma_b^3 \beta_b^2 c^2} \frac{\partial \phi}{\partial x}$$
$$y'' + \frac{(\gamma_b \beta_b)'}{(\gamma_b \beta_b)} y' - \kappa(s)y = -\frac{q}{m\gamma_b^3 \beta_b^2 c^2} \frac{\partial \phi}{\partial y}$$

- ◆ Steps are then identical whether quadrupoles are electric *or* magnetic

Appendix B: The Larmor Transform to Express Solenoidal Focused Particle Equations of Motion in Uncoupled Form

Solenoid equations of motion:

$$x'' + \frac{(\gamma_b \beta_b)'}{(\gamma_b \beta_b)} x' - \frac{B'_{z0}(s)}{2[B\rho]} y - \frac{B_{z0}(s)}{[B\rho]} y' = -\frac{q}{m\gamma_b^3 \beta_b^2 c^2} \frac{\partial \phi}{\partial x}$$

$$y'' + \frac{(\gamma_b \beta_b)'}{(\gamma_b \beta_b)} y' + \frac{B'_{z0}(s)}{2[B\rho]} x + \frac{B_{z0}(s)}{[B\rho]} x' = -\frac{q}{m\gamma_b^3 \beta_b^2 c^2} \frac{\partial \phi}{\partial y}$$

$$B_{z0}(s) = B_z^a(r = 0, z = s) = \text{On-Axis Field}$$

$$[B\rho] = \frac{\gamma_b \beta_b m c}{q} = \text{Rigidity}$$

To simplify algebra, introduce the **complex** coordinate

$$\underline{z} \equiv x + iy \quad i \equiv \sqrt{-1}$$

Note* context clarifies use of i
(particle index, initial cond, complex i)

Then the two equations can be expressed as a single complex equation

$$\underline{z}'' + \frac{(\gamma_b \beta_b)'}{(\gamma_b \beta_b)} \underline{z}' + i \frac{B'_{z0}(s)}{2[B\rho]} \underline{z} + i \frac{B_{z0}(s)}{[B\rho]} \underline{z}' = -\frac{q}{m\gamma_b^3 \beta_b^2 c^2} \left(\frac{\partial \phi}{\partial x} + i \frac{\partial \phi}{\partial y} \right)$$

B1

If the potential is axisymmetric with $\phi = \phi(r)$:

$$\frac{\partial \phi}{\partial x} + i \frac{\partial \phi}{\partial y} = \frac{\partial \phi}{\partial r} \frac{z}{r} \quad r \equiv \sqrt{x^2 + y^2}$$

then the complex form equation of motion reduces to:

$$\underline{z}'' + \frac{(\gamma_b \beta_b)'}{(\gamma_b \beta_b)} \underline{z}' + i \frac{B'_{z0}(s)}{2[B\rho]} \underline{z} + i \frac{B_{z0}(s)}{[B\rho]} \underline{z}' = - \frac{q}{m \gamma_b^3 \beta_b^2 c^2} \frac{\partial \phi}{\partial r} \frac{z}{r}$$

Following Wiedemann, Vol II, pg 82, introduce a transformed complex variable that is a local (s -varying) rotation:

$$\tilde{z} \equiv z e^{-i\tilde{\psi}(s)} = \tilde{x} + i\tilde{y}$$

$\tilde{\psi}(s)$ = phase-function
(real-valued)

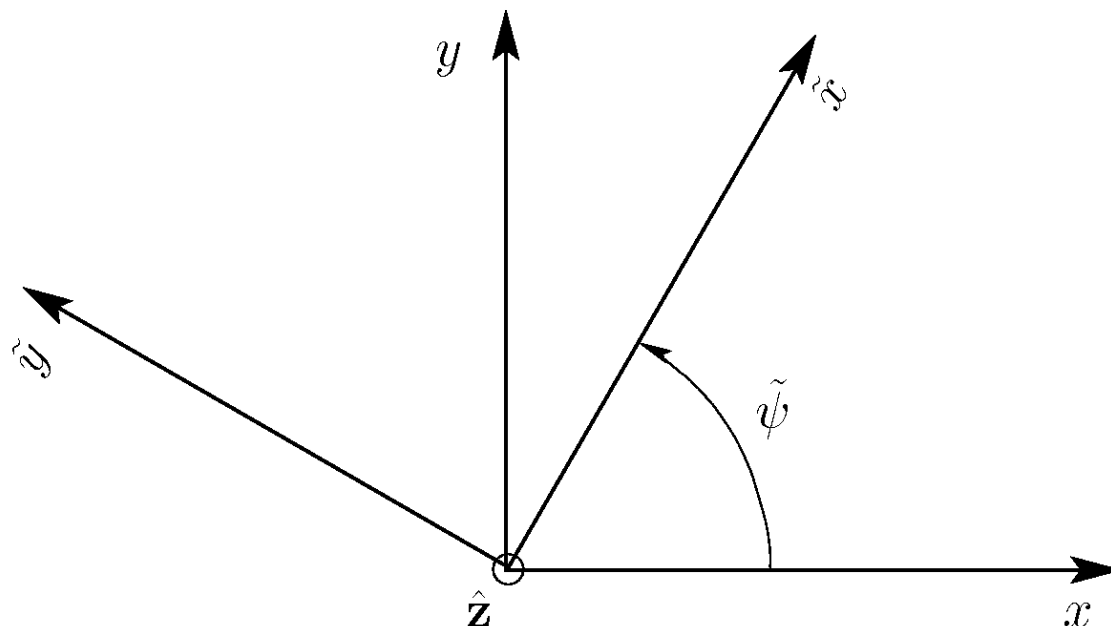

Then: $\underline{z} = \tilde{z} e^{i\tilde{\psi}}$

$$\underline{z}' = \left(\tilde{z}' + i\tilde{\psi}'\tilde{z} \right) e^{i\tilde{\psi}}$$

$$\underline{z}'' = \left(\tilde{z}'' + 2i\tilde{\psi}'\tilde{z}' + i\tilde{\psi}''\tilde{z} - \tilde{\psi}'^2\tilde{z} \right) e^{i\tilde{\psi}}$$

and the complex form equations of motion become:

$$\begin{aligned} \tilde{z}'' + \left[i \left(2\tilde{\psi}' + \frac{B_{z0}}{[B\rho]} \right) + \frac{(\gamma_b\beta_b)'}{(\gamma_b\beta_b)} \right] \tilde{z}' \\ + \left[-\tilde{\psi}'^2 - \frac{B_{z0}}{[B\rho]}\tilde{\psi}' + i \left(\tilde{\psi}'' + \frac{B'_{z0}}{2[B\rho]} + \frac{(\gamma_b\beta_b)'}{(\gamma_b\beta_b)}\tilde{\psi}' \right) \right] \tilde{z} \\ = -\frac{q}{m\gamma_b^3\beta_b^2c^2} \frac{\partial\phi}{\partial r} \frac{\tilde{z}}{r} \end{aligned}$$

Free to choose the form of $\tilde{\psi}$ Can choose to eliminate imaginary terms in $i(\dots)$ in equation by taking:

$$\tilde{\psi}' \equiv -\frac{B_{z0}}{2[B\rho]}$$

$$\implies \tilde{\psi}'' = -\frac{B'_{z0}}{2[B\rho]} + \frac{B_{z0}}{2[B\rho]} \frac{(\gamma_b\beta_b)'}{(\gamma_b\beta_b)}$$

Using these results, the complex form equations of motion reduce to:

B4

$$\underline{\tilde{z}}'' + \frac{(\gamma_b \beta_b)'}{(\gamma_b \beta_b)} \underline{\tilde{z}}' + \left(\frac{B_{z0}}{2[B\rho]} \right)^2 \underline{\tilde{z}} = - \frac{q}{m \gamma_b^3 \beta_b^2 c^2} \frac{\partial \phi}{\partial r} \frac{\underline{\tilde{z}}}{r}$$

Or using $\underline{\tilde{z}} = \tilde{x} + i\tilde{y}$, the equations can be expressed in decoupled \tilde{x} , \tilde{y} variables in the **Larmor Frame** as:

$$\tilde{x}'' + \frac{(\gamma_b \beta_b)'}{(\gamma_b \beta_b)} \tilde{x}' + \kappa(s) \tilde{x} = - \frac{q}{m \gamma_b^3 \beta_b^2 c^2} \frac{\partial \phi}{\partial r} \frac{\tilde{x}}{r}$$

$$\tilde{y}'' + \frac{(\gamma_b \beta_b)'}{(\gamma_b \beta_b)} \tilde{y}' + \kappa(s) \tilde{y} = - \frac{q}{m \gamma_b^3 \beta_b^2 c^2} \frac{\partial \phi}{\partial r} \frac{\tilde{y}}{r}$$

$$\kappa(s) \equiv k_L^2(s) \quad k_L(s) \equiv \frac{B_{z0}(s)}{2[B\rho]} = \frac{\omega_c(s)}{2\gamma_b \beta_b c} \quad [B\rho] = \frac{\gamma_b \beta_b m c}{q}$$

= Larmor Wave-Number

Equations of motion are uncoupled but must be interpreted in the rotating Larmor frame

- ◆ Same form as quadrupoles but with focusing function same sign in each plane

The rotational transformation to the **Larmor Frame** can be effected by integrating the equation for $\tilde{\psi}' = -\frac{B_{z0}}{2[B\rho]}$

$$\tilde{\psi}(s) = - \int_{s_i}^s d\tilde{s} \frac{B_{z0}(\tilde{s})}{2[B\rho]} = - \int_{s_i}^s d\tilde{s} k_L(\tilde{s})$$

Here, s_i is some value of s where the initial conditions are taken.

- ♦ Take $s = s_i$ where axial field is zero for simplest interpretation (see: pg **B6**)

Because

$$\tilde{\psi}' = -\frac{B_{z0}}{2[B\rho]} = \frac{\omega_c}{2\gamma_b\beta_b c}$$

the local $\tilde{x} - \tilde{y}$ Larmor frame is rotating at $\frac{1}{2}$ of the local s -varying cyclotron frequency

- ♦ If $B_{z0} = \text{const}$, then the Larmor frame is uniformly rotating as is well known from elementary textbooks (see problem sets)

The complex form phase-space transformation and inverse transformations are:

$$\begin{aligned}
 \underline{z} &= \underline{\tilde{z}} e^{i\tilde{\psi}} & \underline{\tilde{z}} &= \underline{z} e^{-i\tilde{\psi}} \\
 \underline{z}' &= \left(\underline{\tilde{z}}' + i\tilde{\psi}' \underline{\tilde{z}} \right) e^{i\tilde{\psi}} & \underline{\tilde{z}}' &= \left(\underline{z}' - i\tilde{\psi}' \underline{z} \right) e^{-i\tilde{\psi}} \\
 \underline{z} &= x + iy & \underline{\tilde{z}} &= \tilde{x} + i\tilde{y} & \tilde{\psi}' &= -k_L \\
 \underline{z}' &= x' + iy' & \underline{\tilde{z}}' &= \tilde{x}' + i\tilde{y}'
 \end{aligned}$$

Apply to:

- ◆ Project initial conditions from lab-frame when integrating equations
- ◆ Project integrated solution back to lab-frame to interpret solution

If the initial condition $s = s_i$ is taken **outside of the magnetic field** where $B_{z0}(s_i) = 0$, then:

$$\begin{aligned}
 \tilde{x}(s = s_i) &= x(s = s_i) & \tilde{x}'(s = s_i) &= x'(s = s_i) \\
 \tilde{y}(s = s_i) &= y(s = s_i) & \tilde{y}'(s = s_i) &= y'(s = s_i) \\
 \underline{\tilde{z}}(s = s_i) &= \underline{z}(s = s_i) & \underline{\tilde{z}}'(s = s_i) &= \underline{z}'(s = s_i)
 \end{aligned}$$

The transform and inverse transform between the laboratory and rotating frames can then be applied to project initial conditions into the rotating frame for integration and then the rotating frame solution back into the laboratory frame.

Using the real and imaginary parts of the complex-valued transformations:

$$\begin{bmatrix} x \\ x' \\ y \\ y' \end{bmatrix} = \tilde{\mathbf{M}}_r(s|s_i) \cdot \begin{bmatrix} \tilde{x} \\ \tilde{x}' \\ \tilde{y} \\ \tilde{y}' \end{bmatrix} \quad \begin{bmatrix} \tilde{x} \\ \tilde{x}' \\ \tilde{y} \\ \tilde{y}' \end{bmatrix} = \tilde{\mathbf{M}}_r^{-1}(s|s_i) \cdot \begin{bmatrix} x \\ x' \\ y \\ y' \end{bmatrix}$$

$$\tilde{\mathbf{M}}_r(s|s_i) = \begin{bmatrix} \cos \tilde{\psi} & 0 & -\sin \tilde{\psi} & 0 \\ k_L \sin \tilde{\psi} & \cos \tilde{\psi} & k_L \cos \tilde{\psi} & -\sin \tilde{\psi} \\ \sin \tilde{\psi} & 0 & \cos \tilde{\psi} & 0 \\ -k_L \cos \tilde{\psi} & \sin \tilde{\psi} & k_L \sin \tilde{\psi} & \cos \tilde{\psi} \end{bmatrix}$$

$$\tilde{\mathbf{M}}_r^{-1}(s|s_i) = \begin{bmatrix} \cos \tilde{\psi} & 0 & \sin \tilde{\psi} & 0 \\ k_L \sin \tilde{\psi} & \cos \tilde{\psi} & -k_L \cos \tilde{\psi} & \sin \tilde{\psi} \\ -\sin \tilde{\psi} & 0 & \cos \tilde{\psi} & 0 \\ k_L \cos \tilde{\psi} & -\sin \tilde{\psi} & k_L \sin \tilde{\psi} & \cos \tilde{\psi} \end{bmatrix}$$

Here we used:

$$\tilde{\psi}' = -k_L$$

and it can be verified that:

$$\tilde{\mathbf{M}}_r^{-1} = \text{Inverse}[\tilde{\mathbf{M}}_r]$$

Appendix C: Transfer Matrices for Hard-Edge Solenoidal Focusing

Using results and notation from **Appendix B**, derive transfer matrix for single particle orbit with:

- ◆ No space-charge
- ◆ No momentum spread

◆ Details of decompositions can be found in: Conte and Mackay, “An Introduction to the Physics of Particle Accelerators” (2nd edition; 2008)

First, the solution to the Larmor-frame equations of motion:

$$\begin{aligned}\tilde{x}'' + \frac{(\gamma_b\beta_b)'}{(\gamma_b\beta_b)}\tilde{x}' + \kappa(s)\tilde{x} &= 0 \\ \tilde{y}'' + \frac{(\gamma_b\beta_b)'}{(\gamma_b\beta_b)}\tilde{y}' + \kappa(s)\tilde{y} &= 0\end{aligned}\quad \kappa = k_L^2 = \left(\frac{B_{z0}}{2[B\rho]}\right)^2$$

Can be expressed as:

$$\begin{bmatrix} \tilde{x} \\ \tilde{x}' \\ \tilde{y} \\ \tilde{y}' \end{bmatrix}_z = \tilde{\mathbf{M}}_L(z|z_i) \cdot \begin{bmatrix} \tilde{x} \\ \tilde{x}' \\ \tilde{y} \\ \tilde{y}' \end{bmatrix}_{z=z_i}$$

- ◆ In this appendix we use z rather than s for the axial coordinate since there are not usually bends in a solenoid

C1

Transforming the solution back to the laboratory frame:

$$\begin{aligned}
 & \text{From project of initial conditions} \\
 & \text{to Larmor Frame} \\
 \begin{bmatrix} x \\ x' \\ y \\ y' \end{bmatrix}_z &= \tilde{\mathbf{M}}_r(z|z_i) \cdot \tilde{\mathbf{M}}_L(z|z_i) \cdot \tilde{\mathbf{M}}_r^{-1}(z_i|z_i) \cdot \begin{bmatrix} x \\ x' \\ y \\ y' \end{bmatrix}_{z=z_i} \\
 &= \mathbf{I} \text{ Identity Matrix}
 \end{aligned}$$

- Here we assume the initial condition is outside the magnetic field so that there is no adjustment to the Larmor frame angles, i.e., $\tilde{\mathbf{M}}_r^{-1}(z_i|z_i) = \mathbf{I}$

$$\begin{aligned}
 \begin{bmatrix} x \\ x' \\ y \\ y' \end{bmatrix}_z &\equiv \mathbf{M}(z|z_i) \cdot \begin{bmatrix} x \\ x' \\ y \\ y' \end{bmatrix}_{z=z_i} = \tilde{\mathbf{M}}_r(z|z_i) \cdot \tilde{\mathbf{M}}_L(z|z_i) \cdot \begin{bmatrix} x \\ x' \\ y \\ y' \end{bmatrix}_{z=z_i} \\
 \mathbf{M}(z|z_i) &= \tilde{\mathbf{M}}_r(z|z_i) \cdot \tilde{\mathbf{M}}_L(z|z_i)
 \end{aligned}$$

- Care must be taken when applying to discontinuous (hard-edge) field models of solenoids to correctly calculate transfer matrices
 - Fringe field influences beam “spin-up” and “spin-down” entering and exiting the magnet

Apply formulation to a hard-edge solenoid with no acceleration $[(\gamma_b\beta_b)' = 0]$:

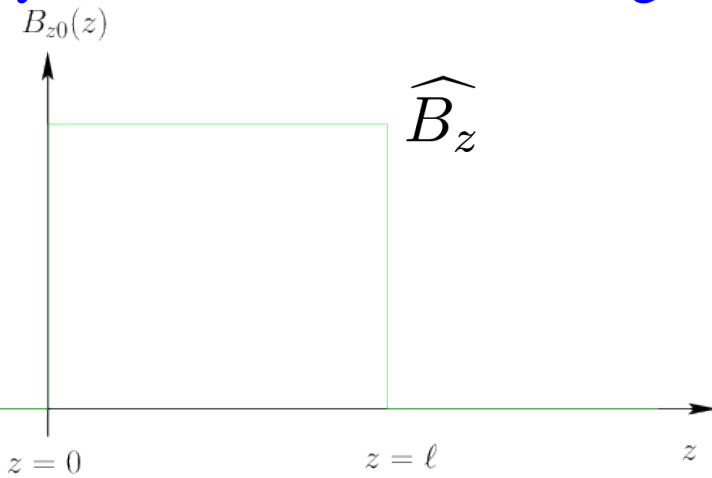

$$B_{z0}(z) = \widehat{B}_z [\Theta(z) - \Theta(z - \ell)]$$

$$\widehat{B}_z = \text{const} = \text{Hard-Edge Field}$$

$$\ell = \text{const} = \text{Hard-Edge Magnet Length}$$

Note coordinate choice: $z=0$ is start of magnet

Calculate the Larmor-frame transfer matrix in $0 \leq z \leq \ell$:

$$\tilde{x}'' + k_L^2 \tilde{x} = 0$$

$$\tilde{y}'' + k_L^2 \tilde{y} = 0$$

$$k_L = \frac{qB_{z0}}{2\gamma_b\beta_b mc} = \frac{B_{z0}}{2[B\rho]} = \frac{\widehat{B}_z}{2[B\rho]} = \text{const}$$

$$0^- \leq z \leq \ell^+$$

$$\tilde{\mathbf{M}}_L(z|0^-) = \begin{bmatrix} C & S/k_L & 0 & 0 \\ -k_L S & C & 0 & 0 \\ 0 & 0 & C & S/k_L \\ 0 & 0 & -k_L S & C \end{bmatrix}$$

$$C \equiv \cos(k_L z) \quad S \equiv \sin(k_L z)$$

Subtle Point:

Larmor frame transfer matrix is valid both sides of discontinuity in focusing entering and exiting solenoid.

The Larmor-frame transfer matrix can be decomposed as:

◆ Useful for later constructs

$$\tilde{\mathbf{M}}_L(z|0^-) = \begin{bmatrix} C & S/k_L & 0 & 0 \\ -k_L S & C & 0 & 0 \\ 0 & 0 & C & S/k_L \\ 0 & 0 & -k_L S & C \end{bmatrix} = \begin{bmatrix} \mathbf{F}(z) & \mathbf{0} \\ \mathbf{0} & \mathbf{F}(z) \end{bmatrix}$$

with

$$\tilde{\mathbf{F}}(z) \equiv \begin{bmatrix} C(z) & S(z)/k_L \\ -k_L S(z) & C(z) \end{bmatrix} \quad \mathbf{0} \equiv \begin{bmatrix} 0 & 0 \\ 0 & 0 \end{bmatrix}$$

Using results from [Appendix E](#), \mathbf{F} can be further decomposed as:

$$\begin{aligned} \tilde{\mathbf{F}}(z) &= \begin{bmatrix} C(z) & S(z)/k_L \\ -k_L S(z) & C(z) \end{bmatrix} \\ &= \begin{bmatrix} 1 & \frac{1}{k_L} \tan\left(\frac{k_L z}{2}\right) \\ 0 & 1 \end{bmatrix} \cdot \begin{bmatrix} 1 & 0 \\ -k_L \sin(k_L z) & 1 \end{bmatrix} \cdot \begin{bmatrix} 1 & \frac{1}{k_L} \tan\left(\frac{k_L z}{2}\right) \\ 0 & 1 \end{bmatrix} \\ &= \mathbf{M}_{\text{drift}}(z) \cdot \mathbf{M}_{\text{thin-lens}}(z) \cdot \mathbf{M}_{\text{drift}}(z) \end{aligned}$$

Applying these results and the formulation of **Appendix B**, we obtain the rotation matrix **within** the magnet $0 < z < \ell$:

- Here we apply $\tilde{\mathbf{M}}_r$ formula with $\tilde{\psi} = -k_L z$ for the hard-edge solenoid

$$\tilde{\mathbf{M}}_r(z|0^-) = \begin{bmatrix} C & 0 & S & 0 \\ -k_L S & C & k_L C & S \\ -S & 0 & C & 0 \\ -k_L C & -S & -k_L S & C \end{bmatrix}$$

Comment: Careful with minus signs! Here, C and S here have positive arguments as defined.

With special magnet **end-forms**:

- Here we exploit continuity of $\tilde{\mathbf{M}}_r$ in Larmor frame

Entering solenoid

$$\tilde{\mathbf{M}}_r(0^+|0^-) = \begin{bmatrix} 1 & 0 & 0 & 0 \\ 0 & 1 & k_L & 0 \\ 0 & 0 & 1 & 0 \\ -k_L & 0 & 0 & 1 \end{bmatrix}$$

- Direct plug-in from formula above for $\tilde{\mathbf{M}}_r$ at $z = 0^+$

Exiting solenoid

$$\tilde{\mathbf{M}}_r(\ell^+|\ell^-) = \begin{bmatrix} 1 & 0 & 0 & 0 \\ 0 & 1 & -k_L & 0 \\ 0 & 0 & 1 & 0 \\ k_L & 0 & 0 & 1 \end{bmatrix}$$

- Slope of fringe field is reversed so replace in entrance formula: $k_L \rightarrow -k_L$

C5

The rotation matrix through the full solenoid is (plug in to previous formula for $\tilde{\mathbf{M}}_r(z|0^-)$):

$$\tilde{\mathbf{M}}_r(\ell^+|0^-) = \begin{bmatrix} \cos \Phi & 0 & \sin \Phi & 0 \\ 0 & \cos \Phi & 0 & \sin \Phi \\ -\sin \Phi & 0 & \cos \Phi & 0 \\ 0 & -\sin \Phi & 0 & \cos \Phi \end{bmatrix} = \begin{bmatrix} \mathbf{I} \cos \Phi & \mathbf{I} \sin \Phi \\ -\mathbf{I} \sin \Phi & \mathbf{I} \cos \Phi \end{bmatrix}$$

$$\Phi \equiv k_L \ell \qquad \mathbf{I} \equiv \begin{bmatrix} 1 & 0 \\ 0 & 1 \end{bmatrix}$$

and the rotation matrix within the solenoid is (plug into formula for $\tilde{\mathbf{M}}_r(z|0^-)$ and apply algebra to resolve sub-forms):

$$\tilde{\mathbf{M}}_r(z|0^-) = \begin{bmatrix} C(z) & 0 & S(z) & 0 \\ 0 & C(z) & 0 & S(z) \\ -S(z) & 0 & C(z) & 0 \\ 0 & -S(z) & 0 & C(z) \end{bmatrix} \cdot \begin{bmatrix} 1 & 0 & 0 & 0 \\ 0 & 1 & k_L & 0 \\ 0 & 0 & 1 & 0 \\ -k_L & 0 & 0 & 1 \end{bmatrix}$$

$$= \begin{bmatrix} C(z)\mathbf{I} & S(z)\mathbf{I} \\ -S(z)\mathbf{I} & C(z)\mathbf{I} \end{bmatrix} \cdot \begin{bmatrix} \mathbf{I} & \mathbf{K} \\ -\mathbf{K} & \mathbf{I} \end{bmatrix} \qquad \mathbf{K} \equiv \begin{bmatrix} 0 & 0 \\ k_L & 0 \end{bmatrix}$$

$$= \tilde{\mathbf{M}}_r(z|0^+) \cdot \tilde{\mathbf{M}}_r(0^+|0^-) \qquad 0 < z < \ell$$

Note that the rotation matrix kick entering the solenoid is expressible as

$$\tilde{\mathbf{M}}_r(0^+|0^-) = \begin{bmatrix} \mathbf{I} & \mathbf{K} \\ -\mathbf{K} & \mathbf{I} \end{bmatrix}$$

C6

The lab-frame advance matrices are then (after expanding matrix products):

Inside Solenoid $0^+ \leq z \leq \ell^-$

$$\mathbf{M}(z|0^-) = \tilde{\mathbf{M}}_r(z|0^-)\tilde{\mathbf{M}}_L(z|0^-)$$

$$= \begin{bmatrix} \cos^2 \phi & \frac{1}{2k_L} \sin(2\phi) & \frac{1}{2} \sin(2\phi) & \frac{1}{k_L} \sin^2 \phi \\ -k_L \sin(2\phi) & \cos(2\phi) & k_L \cos(2\phi) & \sin(2\phi) \\ -\frac{1}{2} \sin(2\phi) & -\frac{1}{k_L} \sin^2 \phi & \cos^2 \phi & \frac{1}{2k_L} \sin(2\phi) \\ -k_L \cos(2\phi) & -\sin(2\phi) & -k_L \sin(2\phi) & \cos(2\phi) \end{bmatrix}$$

$$\phi \equiv k_L z$$

$$= \begin{bmatrix} C(z)\mathbf{I} & S(z)\mathbf{I} \\ -S(z)\mathbf{I} & C(z)\mathbf{I} \end{bmatrix} \cdot \begin{bmatrix} \mathbf{I} & \mathbf{K} \\ -\mathbf{K} & \mathbf{I} \end{bmatrix} \cdot \begin{bmatrix} \mathbf{F}(z) & \mathbf{0} \\ \mathbf{0} & \mathbf{F}(z) \end{bmatrix}$$

$$= \begin{bmatrix} C(z)\mathbf{I} - S(z)\mathbf{K} & C(z)\mathbf{K} + S(z)\mathbf{I} \\ -C(z)\mathbf{K} - S(z)\mathbf{I} & C(z)\mathbf{I} - S(z)\mathbf{K} \end{bmatrix} \cdot \begin{bmatrix} \mathbf{F}(z) & \mathbf{0} \\ \mathbf{0} & \mathbf{F}(z) \end{bmatrix}$$

$$= \begin{bmatrix} C(z)\mathbf{F}(z) - S(z)\mathbf{K} \cdot \mathbf{F}(z) & C(z)\mathbf{K} \cdot \mathbf{F}(z) + S(z)\mathbf{F}(z) \\ -C(z)\mathbf{K} \cdot \mathbf{F}(z) - S(z)\mathbf{F}(z) & C(z)\mathbf{F}(z) - S(z)\mathbf{K} \cdot \mathbf{F}(z) \end{bmatrix}$$

◆ 2nd forms useful to see structure of transfer matrix

Through entire Solenoid $z = \ell^+$

$$\mathbf{M}(\ell^+|0^-) = \tilde{\mathbf{M}}_r(\ell^+|0^-)\tilde{\mathbf{M}}_L(\ell^+|0^-)$$

$$= \begin{bmatrix} \cos^2 \Phi & \frac{1}{2k_L} \sin(2\Phi) & \frac{1}{2} \sin(2\Phi) & \frac{1}{k_L} \sin^2 \Phi \\ -\frac{k_L}{2} \sin(2\Phi) & \cos^2 \Phi & -k_L \sin^2 \Phi & \frac{1}{2} \sin(2\Phi) \\ -\frac{1}{2} \sin(2\Phi) & -\frac{1}{k_L} \sin^2 \Phi & \cos^2 \Phi & \frac{1}{2k_L} \sin(2\Phi) \\ k_L \sin^2 \Phi & -\frac{1}{2} \sin(2\Phi) & -\frac{k_L}{2} \sin(2\Phi) & \cos^2 \Phi \end{bmatrix}$$

$$\Phi \equiv k_L \ell$$

$$= \begin{bmatrix} \cos \Phi \mathbf{I} & \sin \Phi \mathbf{I} \\ -\sin \Phi \mathbf{I} & \cos \Phi \mathbf{I} \end{bmatrix} \cdot \begin{bmatrix} \mathbf{F}(\ell) & \mathbf{0} \\ \mathbf{0} & \mathbf{F}(\ell) \end{bmatrix}$$

$$= \begin{bmatrix} \cos \Phi \mathbf{F}(\ell) & \sin \Phi \mathbf{F}(\ell) \\ -\sin \Phi \mathbf{F}(\ell) & \cos \Phi \mathbf{F}(\ell) \end{bmatrix}$$

♦ 2nd forms useful to see structure of transfer matrix

Note that due to discontinuous fringe field:

$$\mathbf{M}(0^+|0^-) = \begin{bmatrix} 1 & 0 & 0 & 0 \\ 0 & 1 & k_L & 0 \\ 0 & 0 & 1 & 0 \\ -k_L & 0 & 0 & 1 \end{bmatrix} = \begin{bmatrix} \mathbf{I} & \mathbf{K} \\ -\mathbf{K} & \mathbf{I} \end{bmatrix} \neq I \quad \text{Fringe going in} \\ \text{kicks angles of beam}$$

C8

$\mathbf{M}(\ell^-|0^-) \neq \mathbf{M}(\ell^+|0^-)$ Due to fringe exiting
kicking angles of beam

In more realistic model with a continuously varying fringe to zero, all transfer matrix components will vary continuously across boundaries

- Still important to get this right in idealized designs often taken as a first step!

Focusing kicks on particles entering/exiting the solenoid can be calculated as:

Entering:

$$\begin{aligned}x(0^+) &= x(0^-) & x'(0^+) &= x'(0^-) + k_L y(0^-) \\y(0^+) &= y(0^-) & y'(0^+) &= y'(0^-) - k_L x(0^-)\end{aligned}$$

Exiting:

$$\begin{aligned}x(\ell^+) &= x(\ell^-) & x'(\ell^+) &= x'(\ell^-) - k_L y(\ell^-) \\y(\ell^+) &= y(\ell^-) & y'(\ell^+) &= y'(\ell^-) + k_L x(\ell^-)\end{aligned}$$

- ◆ Beam spins up/down on entering/exiting the (abrupt) magnetic fringe field
- ◆ Sense of rotation changes with entry/exit of hard-edge field.

The transfer matrix for a hard-edge solenoid can be resolved into thin-lens kicks entering and exiting the optic and an rotation in the central region of the optic as:

$$\begin{aligned}
 \mathbf{M}(\ell^+|0^-) &= \tilde{\mathbf{M}}_r(\ell^+|0^-)\tilde{\mathbf{M}}_L(\ell^+|0^-) \\
 &= \begin{bmatrix} \cos^2 \Phi & \frac{1}{2k_L} \sin(2\Phi) & \frac{1}{2} \sin(2\Phi) & \frac{1}{k_L} \sin^2 \Phi \\ -\frac{k_L}{2} \sin(2\Phi) & \cos^2 \Phi & -k_L \sin^2 \Phi & \frac{1}{2} \sin(2\Phi) \\ -\frac{1}{2} \sin(2\Phi) & -\frac{1}{k_L} \sin^2 \Phi & \cos^2 \Phi & \frac{1}{2k_L} \sin(2\Phi) \\ k_L \sin^2 \Phi & -\frac{1}{2} \sin(2\Phi) & -\frac{k_L}{2} \sin(2\Phi) & \cos^2 \Phi \end{bmatrix} \\
 &= \begin{bmatrix} 1 & 0 & 0 & 0 \\ 0 & 1 & -k_L & 0 \\ 0 & 0 & 1 & 0 \\ k_L & 0 & 0 & 1 \end{bmatrix} \begin{bmatrix} 1 & \frac{1}{2k_L} \sin(2\Phi) & 0 & \frac{1}{k_L} \sin^2 \Phi \\ 0 & \cos(2\Phi) & 0 & \sin(2\Phi) \\ 0 & \frac{1}{k_L} \sin^2 \Phi & 1 & \frac{1}{2k_L} \sin(2\Phi) \\ 1 & -\sin(2\Phi) & 0 & \cos(2\Phi) \end{bmatrix} \begin{bmatrix} 1 & 0 & 0 & 0 \\ 0 & 1 & k_L & 0 \\ 0 & 0 & 1 & 0 \\ -k_L & 0 & 0 & 1 \end{bmatrix} \\
 &= \mathbf{M}(\ell^+|\ell^-) \cdot \mathbf{M}(\ell^-|0^+) \cdot \mathbf{M}(0^+|0^-)
 \end{aligned}$$

where $\Phi \equiv k_L \ell$

- ◆ Focusing effect effectively from thin lens kicks at entrance/exit of solenoid as particle traverses the (abrupt here) fringe field

The transfer matrix for the hard-edge solenoid is exact within the context of linear optics. However, real solenoid magnets have an axial fringe field. An obvious need is how to best set the hard-edge parameters B_z , ℓ from the real fringe field.

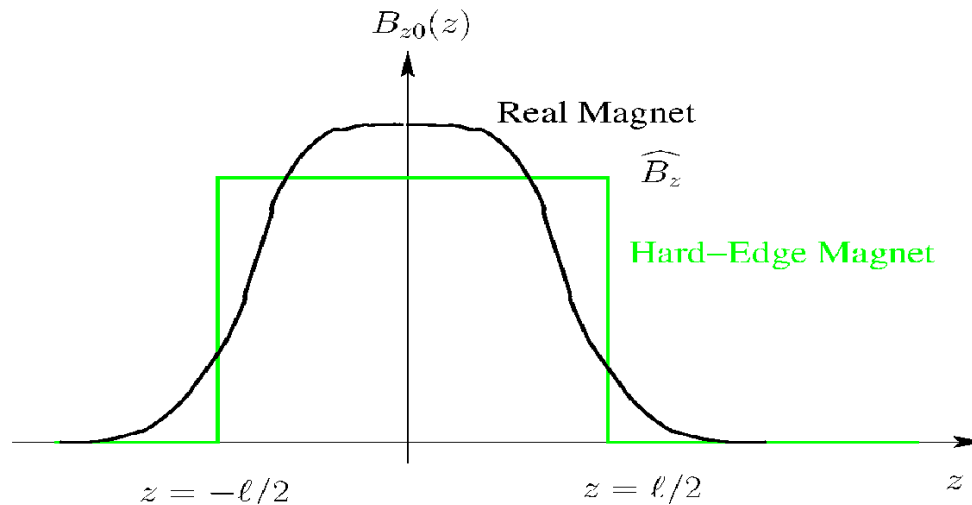

Hard-Edge and Real Magnets axially centered to compare

Simple physical motivated prescription by requiring:

1) Equivalent Linear Focus Impulse $\propto \int dz k_L^2 \propto \int dz B_{z0}^2$

$$\implies \int_{-\infty}^{\infty} dz B_{z0}^2(z) = \ell \widehat{B}_z^2$$

2) Equivalent Net Larmor Rotation Angle $\propto \int dz k_L \propto \int dz B_{z0}$

$$\implies \int_{-\infty}^{\infty} dz B_{z0}(z) = \ell \widehat{B}_z$$

Solve 1) and 2) for hard edge parameters \widehat{B}_z , ℓ

$$\widehat{B}_z = \frac{\int_{-\infty}^{\infty} dz B_{z0}^2(z)}{\int_{-\infty}^{\infty} dz B_{z0}(z)}$$
$$\ell = \frac{\left[\int_{-\infty}^{\infty} dz B_{z0}(z) \right]^2}{\int_{-\infty}^{\infty} dz B_{z0}^2(z)}$$

Appendix D: Axisymmetric Applied Magnetic or Electric Field Expansion

Static, rationally symmetric static applied fields \mathbf{E}^a , \mathbf{B}^a satisfy the vacuum Maxwell equations in the beam aperture:

$$\nabla \cdot \mathbf{E}^a = 0 \quad \nabla \times \mathbf{E}^a = 0 \quad \nabla \cdot \mathbf{B}^a = 0 \quad \nabla \times \mathbf{B}^a = 0$$

This implies we can take for some electric potential ϕ^e and magnetic potential ϕ^m :

$$\mathbf{E}^a = -\nabla\phi^e \quad \mathbf{B}^a = -\nabla\phi^m$$

which in the vacuum aperture satisfies the Laplace equations:

$$\nabla^2\phi^e = 0 \quad \nabla^2\phi^m = 0$$

We will analyze the magnetic case and the electric case is analogous. In axisymmetric ($\partial/\partial\theta = 0$) geometry we express Laplace's equation as:

$$\nabla^2\phi^m(r, z) = \frac{1}{r} \frac{\partial}{\partial r} \left(r \frac{\partial\phi^m}{\partial r} \right) + \frac{\partial^2\phi^m}{\partial z^2} = 0$$

$\phi^m(r, z)$ can be expanded as (odd terms in r would imply nonzero $B_r = -\frac{\partial\phi^m}{\partial r}$ at $r = 0$):

$$\phi^m(r, z) = \sum_{\nu=0}^{\infty} f_{2\nu}(z)r^{2\nu} = f_0 + f_2r^2 + f_4r^4 + \dots$$

where $f_0 = \phi^m(r = 0, z)$ is the on-axis potential

D1

Plugging ϕ^m into Laplace's equation yields the recursion relation for $f_{2\nu}$

$$(2\nu + 2)^2 f_{2\nu+2} + f_{2\nu}'' = 0$$

Iteration then shows that

$$\phi^m(r, z) = \sum_{\nu=0}^{\infty} \frac{(-1)^\nu}{(\nu!)^2} \frac{\partial^{2\nu} f(0, z)}{\partial z^{2\nu}} \left(\frac{r}{2}\right)^{2\nu}$$

Using $B_z^a(r=0, z) \equiv B_{z0}(z) = -\frac{\partial\phi_m(0, z)}{\partial z}$ and differentiating yields:

$$B_r^a(r, z) = -\frac{\partial\phi_m}{\partial r} = \sum_{\nu=1}^{\infty} \frac{(-1)^\nu}{(\nu!)(\nu-1)!} \frac{\partial^{2\nu-1} B_{z0}(z)}{\partial z^{2\nu-1}} \left(\frac{r}{2}\right)^{2\nu-1}$$

$$B_z^a(r, z) = -\frac{\partial\phi_m}{\partial z} = \sum_{\nu=0}^{\infty} \frac{(-1)^\nu}{(\nu!)^2} \frac{\partial^{2\nu} B_{z0}(z)}{\partial z^{2\nu}} \left(\frac{r}{2}\right)^{2\nu}$$

- ◆ Electric case immediately analogous and can arise in electrostatic Einzel lens focusing systems often employed near injectors
- ◆ Electric case can also be applied to RF and induction gap structures in the quasistatic (long RF wavelength relative to gap) limit.

D2

Appendix E: Thin Lens Equivalence for Thick Lenses

In the thin lens model for an orbit described by Hill's equation:

$$x''(s) + \kappa_x(s)x(s) = 0$$

the applied focusing function $\kappa_x(s)$ is replaced by a “thin-lens” kick described by:

$$\kappa_x(s) = \frac{1}{f} \delta(s - s_0) \quad \begin{array}{l} s_0 = \text{Optic Location} = \text{const} \\ f = \text{focal length} = \text{const} \end{array}$$

The transfer matrix to describe the action of the thin lens is found by integrating the Hill's equation to be:

$$\begin{bmatrix} x \\ x' \end{bmatrix}_{s=s_0^+} = \begin{bmatrix} 1 & 0 \\ -1/f & 1 \end{bmatrix} \cdot \begin{bmatrix} x \\ x' \end{bmatrix}_{s=s_0^-} \equiv \mathbf{M}_{\text{kick}} \begin{bmatrix} x \\ x' \end{bmatrix}_{s=s_0^-}$$

Graphical Interpretation:

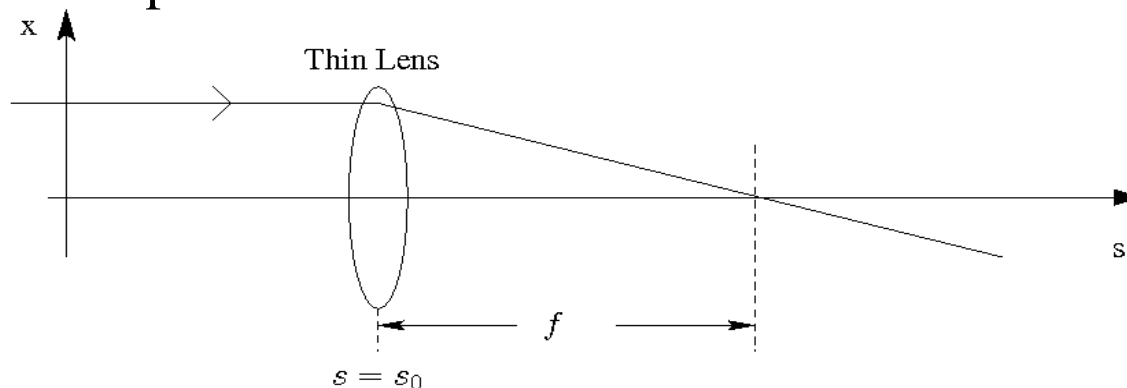

For a free drift, Hill's equation is:

$$x''(s) = 0$$

with a corresponding transfer matrix solution:

$$\begin{bmatrix} x \\ x' \end{bmatrix}_s = \begin{bmatrix} 1 & (s - s_i) \\ 0 & 1 \end{bmatrix} \cdot \begin{bmatrix} x \\ x' \end{bmatrix}_{s_i} \equiv \mathbf{M}_{\text{drift}} \begin{bmatrix} x \\ x' \end{bmatrix}_{s_i}$$

We will show that the thin lens and two drifts can *exactly* replace

Case 1) Piecewise constant focusing lens: $\kappa_x(s) = \kappa = \text{const} > 0$

Case 2) Piecewise constant defocusing lens: $\kappa_x(s) = -\kappa = \text{const} < 0$

Case 3) Arbitrary linear lens represented by: $\kappa_x(s)$

This can be helpful since the thin lens + drift model is simple both to carry out algebra and conceptually understand.

Case 1) The piecewise constant focusing transfer matrix \mathbf{M}_x for $\kappa_x = \kappa > 0$ can be resolved as:

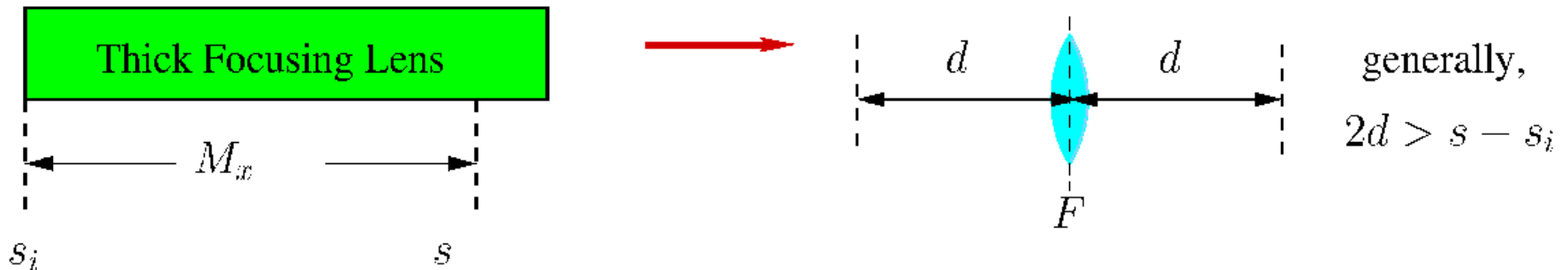

$$\begin{aligned} \mathbf{M}_x(s|s_i) &= \begin{bmatrix} C(s) & S(s)/\sqrt{\kappa} \\ -\sqrt{\kappa}S(s) & C(s) \end{bmatrix} \\ &= \begin{bmatrix} 1 & d(s) \\ 0 & 1 \end{bmatrix} \cdot \begin{bmatrix} 1 & 0 \\ -1/f(s) & 1 \end{bmatrix} \cdot \begin{bmatrix} 1 & d(s) \\ 0 & 1 \end{bmatrix} \\ &\equiv \mathbf{M}_{\text{drift}} \cdot \mathbf{M}_{\text{kick}} \cdot \mathbf{M}_{\text{drift}} \end{aligned}$$

where $C(s) = \cos[\sqrt{\kappa}(s - s_i)]$ $d(s) = \tan[\sqrt{\kappa}(s - s_i)/2]/\sqrt{\kappa}$
 $S(s) = \sin[\sqrt{\kappa}(s - s_i)]$ $1/f(s) = \sqrt{\kappa}S(s)$

This resolves the thick focusing lens into a thin-lens kick \mathbf{M}_{kick} between two equal length drifts $\mathbf{M}_{\text{drift}}$ upstream and downstream of the kick

- ◆ Result specifies *exact* thin-lens equivalent focusing element
- ◆ Can also be applied to continuous focusing (in interval) and solenoid focusing (in Larmor frame, see [S2E](#) and [Appendix C](#)) by substituting appropriately for κ
- ◆ Must adjust element length consistently with composite replacement **E3**

Case 2) The piecewise constant de-focusing transfer matrix \mathbf{M}_x for $\kappa_x = -\kappa < 0$ can be resolved as:

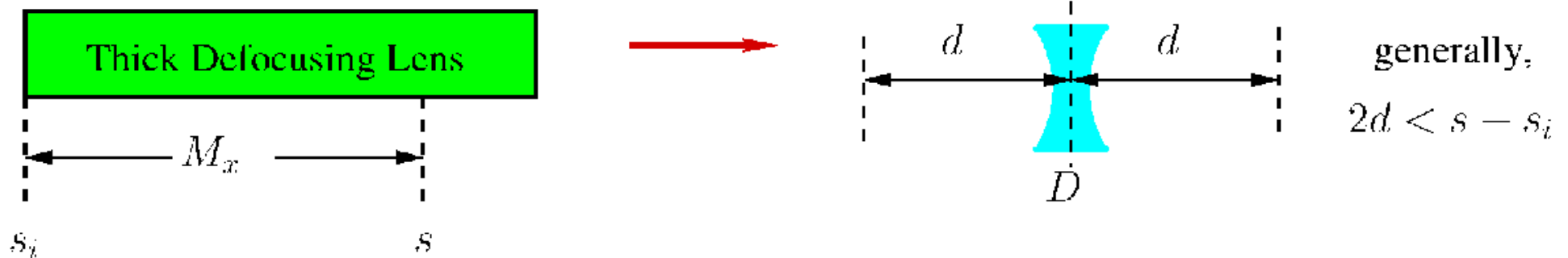

$$\begin{aligned}
 \mathbf{M}_{\mathbf{x}}(s|s_i) &= \begin{bmatrix} \text{Ch}(s) & \text{Sh}(s)/\sqrt{\kappa} \\ \sqrt{\kappa}\text{Sh}(s) & \text{Ch}(s) \end{bmatrix} \\
 &= \begin{bmatrix} 1 & d(s) \\ 0 & 1 \end{bmatrix} \cdot \begin{bmatrix} 1 & 0 \\ 1/f(s) & 1 \end{bmatrix} \cdot \begin{bmatrix} 1 & d(s) \\ 0 & 1 \end{bmatrix} \\
 &\equiv \mathbf{M}_{\text{drift}} \cdot \mathbf{M}_{\text{kick}} \cdot \mathbf{M}_{\text{drift}}
 \end{aligned}$$

where

$$\begin{aligned}
 \text{Ch}(s) &= \cosh[\sqrt{\kappa}(s - s_i)] & d(s) &= \tanh[\sqrt{\kappa}(s - s_i)/2]/\sqrt{\kappa} \\
 \text{Sh}(s) &= \sinh[\sqrt{\kappa}(s - s_i)] & 1/f(s) &= \sqrt{\kappa}\text{Sh}(s)
 \end{aligned}$$

- ◆ Result is *exact* thin-lens equivalent defocusing element
- ◆ Can be applied together with thin lens focus replacement to more simply derive phase-advance formulas etc for AG focusing lattices
- ◆ Must adjust element length consistently with composite replacement

Case 3) General element replacement with an equivalent thin lens

Consider a general transport matrix:

$$\mathbf{M} = \begin{bmatrix} M_{11} & M_{12} \\ M_{21} & M_{22} \end{bmatrix} \quad \det \mathbf{M} = M_{11}M_{22} - M_{12}M_{21} = 1$$

◆ Always true for linear optics, see Sec **S5**

A transfer matrix of a drift of length d_1 followed by a thin lens of strength f , followed by a drift of length d_2 gives:

$$\mathbf{M}_{\text{drift2+thin+drift1}} = \begin{bmatrix} 1 & d_2 \\ 0 & 1 \end{bmatrix} \cdot \begin{bmatrix} 1 & 0 \\ -1/f & 1 \end{bmatrix} \cdot \begin{bmatrix} 1 & d_1 \\ 0 & 1 \end{bmatrix}$$

$$\text{Setting } \mathbf{M} = \mathbf{M}_{\text{drift2+thin+drift1}} = \begin{bmatrix} 1 - d_2/f & d_1 + d_2 - d_1d_2/f \\ -1/f & 1 - d_1/f \end{bmatrix}$$

$$d_1 = (M_{22} - 1)/M_{21}$$

$$d_2 = (M_{11} - 1)/M_{21}$$

$$-1/f = M_{21}$$

◆ M_{12} implicitly involved due to unit determinant constraint

Discussions of this, and similar results can be found in older optics books such as: Banford, *The Transport of Charged Particle Beams*, 1965. **E5**

Comments:

- ◆ Shows that *any* linear optic (thick or thin) can be resolved into an equivalent thin lens kick + drifts
 - Use requires element effective length in drift + thin-lens-kick + drift to be adjusted consistently
 - - Care must be taken to interpret lattice period with potentially different axial extent focusing elements correctly
- ◆ Orbits in thin-lens replacements may differ a little in max excursions etc, but this shows simple and rapid design estimates can be made using thin lens models if proper equivalences are employed
 - Analysis of thin lens + drifts can simplify interpretation and algebraic steps
- ◆ Construct applies to solenoidal focusing also if the orbit is analyzed in the Larmor frame where the decoupled orbit can be analyzed with Hill's equation, but it does *not* apply in the laboratory frame
 - Piecewise constant (hard-edge) solenoid in lab frame can be resolved into a rotation + thin-lens kick structure though (see [Appendix C](#))

S3: Description of Applied Focusing Fields

S3A: Overview

Applied fields for focusing, bending, and acceleration enter the equations of motion via:

$$\mathbf{E}^a = \text{Applied Electric Field}$$

$$\mathbf{B}^a = \text{Applied Magnetic Field}$$

Generally, these fields are produced by sources (often static or slowly varying in time) located outside an aperture or so-called pipe radius $r = r_p$. For example, the **electric** and **magnetic** quadrupoles of **S2**:

Electric Quadrupole

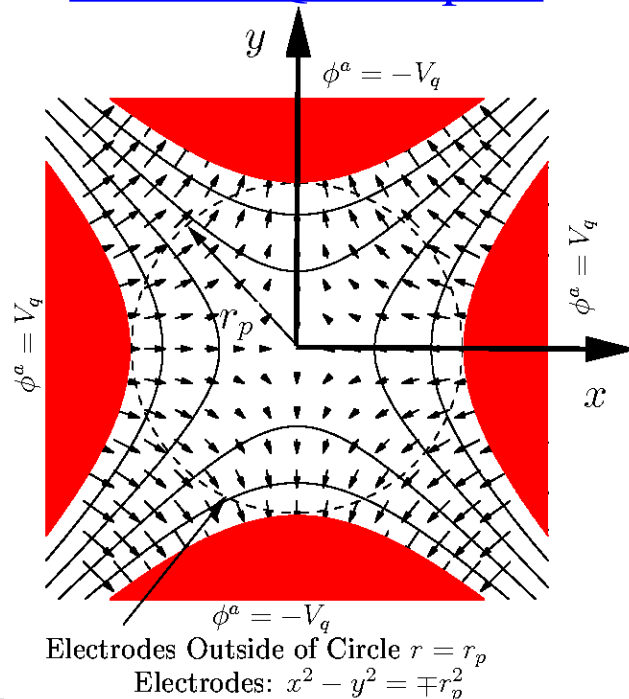

Hyperbolic material surfaces outside pipe radius

$$r = r_p$$

Magnetic Quadrupole

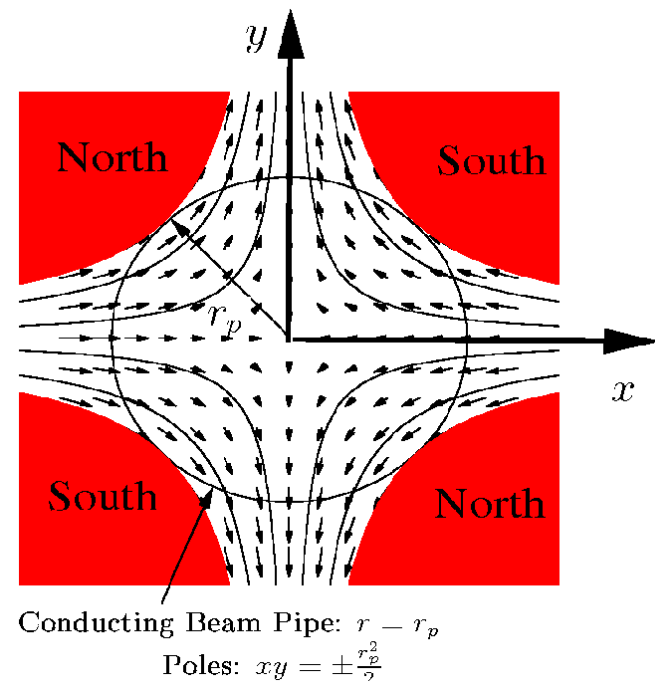

The fields of such classes of magnets obey the **vacuum Maxwell Equations** within the aperture:

$$\begin{aligned}\nabla \cdot \mathbf{E}^a &= 0 & \nabla \cdot \mathbf{B}^a &= 0 \\ \nabla \times \mathbf{E}^a &= -\frac{\partial}{\partial t} \mathbf{B}^a & \nabla \times \mathbf{B}^a &= \frac{1}{c^2} \frac{\partial}{\partial t} \mathbf{E}^a\end{aligned}$$

If the fields are static or sufficiently slowly varying (quasistatic) where the time derivative terms can be neglected, then the fields in the aperture will obey the **static vacuum Maxwell equations**:

$$\begin{aligned}\nabla \cdot \mathbf{E}^a &= 0 & \nabla \cdot \mathbf{B}^a &= 0 \\ \nabla \times \mathbf{E}^a &= 0 & \nabla \times \mathbf{B}^a &= 0\end{aligned}$$

In general, optical elements are tuned to **limit** the strength of **nonlinear field terms** so the beam experiences primarily **linear applied fields**.

- ◆ Linear fields allow better preservation of beam quality

Removal of *all* nonlinear fields cannot be accomplished

- ◆ 3D structure of the Maxwell equations precludes for finite geometry optics
- ◆ Even in finite geometries deviations from optimal structures and symmetry will result in nonlinear fields

As an example of this, when an ideal 2D iron magnet with infinite hyperbolic poles is truncated radially for finite 2D geometry, this leads to nonlinear focusing fields even in 2D:

- ◆ Truncation necessary along with confinement of return flux in yoke

Cross-Sections of Iron Quadrupole Magnets

Ideal (infinite geometry)

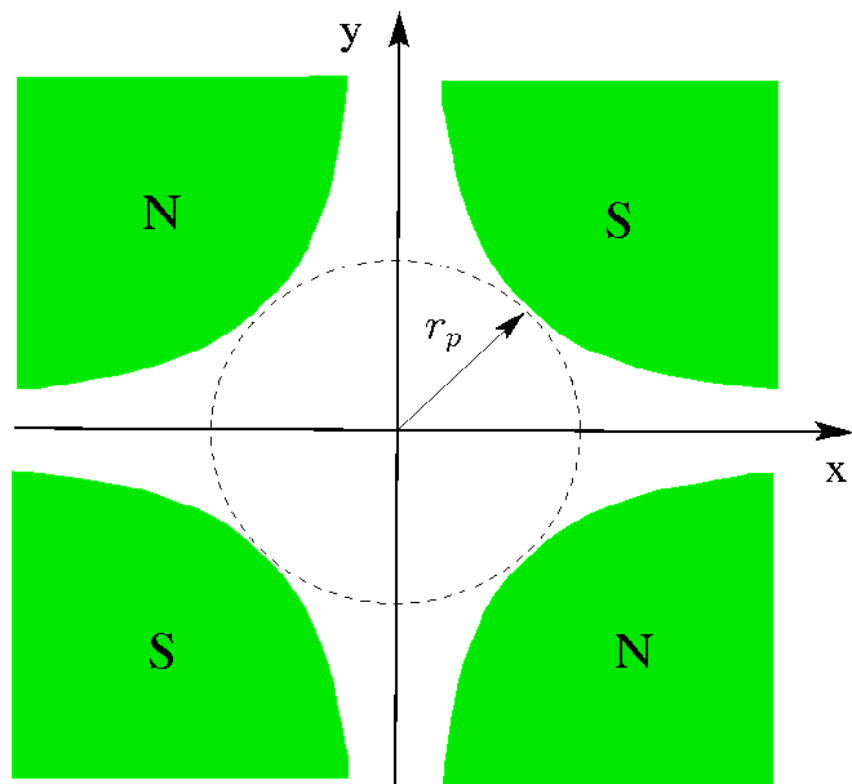

Hyperbolic Iron Pole Sections
(infinite)

Practical (finite geometry)

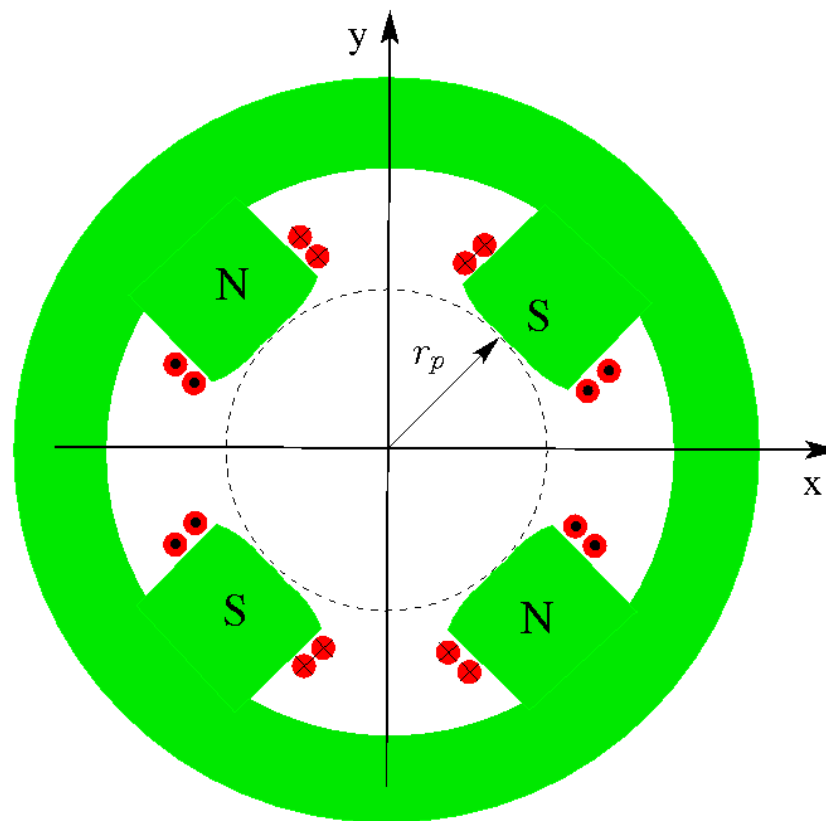

Shaped Iron Pole Sections
(finite)

The design of optimized electric and magnetic optics for accelerators is a specialized topic with a vast literature. It is not possible to cover this topic in this brief survey. In the remaining part of this section we will overview a limited subset of material on [magnetic optics](#) including:

- ◆ (see: [S3B](#)) [Magnetic field expansions](#) for focusing and bending
- ◆ (see: [S3C](#)) [Hard edge equivalent models](#)
- ◆ (see: [S3D](#)) [2D multipole models](#) and nonlinear field scalings
- ◆ (see: [S3E](#)) [Good field radius](#)

Much of the material presented can be immediately applied to static [Electric Optics](#) since the vacuum Maxwell equations are the same for static Electric \mathbf{E}^a and Magnetic \mathbf{B}^a fields in vacuum.

S3B: Magnetic Field Expansions for Focusing and Bending

Forces from transverse ($B_z^a = 0$) magnetic fields enter the transverse equations of motion (see: **S1**, **S2**) via:

Force: $\mathbf{F}_\perp^a \simeq q\beta_b c \hat{\mathbf{z}} \times \mathbf{B}_\perp^a$

Field: $\mathbf{B}_\perp^a = \hat{\mathbf{x}}B_x^a + \hat{\mathbf{y}}B_y^a$

Combined these give:

$$F_x^a \simeq -q\beta_b c B_y^a$$

$$F_y^a \simeq q\beta_b c B_x^a$$

Field components entering these expressions can be expanded about $\mathbf{x}_\perp = 0$

◆ Element center and design orbit taken to be at $\mathbf{x}_\perp = 0$

$$B_x^a = B_x^a(0) + \frac{\partial B_x^a}{\partial y}(0)y + \frac{\partial B_x^a}{\partial x}(0)x$$

Nonlinear Focus

$$+ \frac{1}{2} \frac{\partial^2 B_x^a}{\partial x^2}(0)x^2 + \frac{\partial^2 B_x^a}{\partial x \partial y}(0)xy + \frac{1}{2} \frac{\partial^2 B_x^a}{\partial y^2}(0)y^2 + \dots$$

$$B_y^a = B_y^a(0) + \frac{\partial B_y^a}{\partial x}(0)x + \frac{\partial B_y^a}{\partial y}(0)y$$

Nonlinear Focus

$$+ \frac{1}{2} \frac{\partial^2 B_y^a}{\partial x^2}(0)x^2 + \frac{\partial^2 B_y^a}{\partial x \partial y}(0)xy + \frac{1}{2} \frac{\partial^2 B_y^a}{\partial y^2}(0)y^2 + \dots$$

Terms:

1: Dipole Bend

2: Normal

Quad Focus

3: Skew

Quad Focus

Sources of undesired nonlinear applied field components include:

- ◆ Intrinsic finite 3D geometry and the structure of the Maxwell equations
- ◆ Systematic errors or sub-optimal geometry associated with practical trade-offs in fabricating the optic
- ◆ Random construction errors in individual optical elements
- ◆ Alignment errors of magnets in the lattice giving field projections in unwanted directions
- ◆ Excitation errors effecting the field strength
 - Currents in coils not correct and/or unbalanced

More advanced treatments exploit less simple power-series expansions to express symmetries more clearly:

- ◆ Maxwell equations constrain structure of solutions
 - Expansion coefficients are NOT all independent
- ◆ Forms appropriate for bent coordinate systems in dipole bends can become complicated

S3C: Hard Edge Equivalent Models

Real 3D magnets can often be modeled with sufficient accuracy by 2D **hard-edge** “**equivalent**” magnets that give the same approximate focusing impulse to the particle as the full 3D magnet

- ♦ Objective is to provide same approximate applied focusing “kick” to particles with different focusing gradient functions $G(s)$

See Figure Next Slide

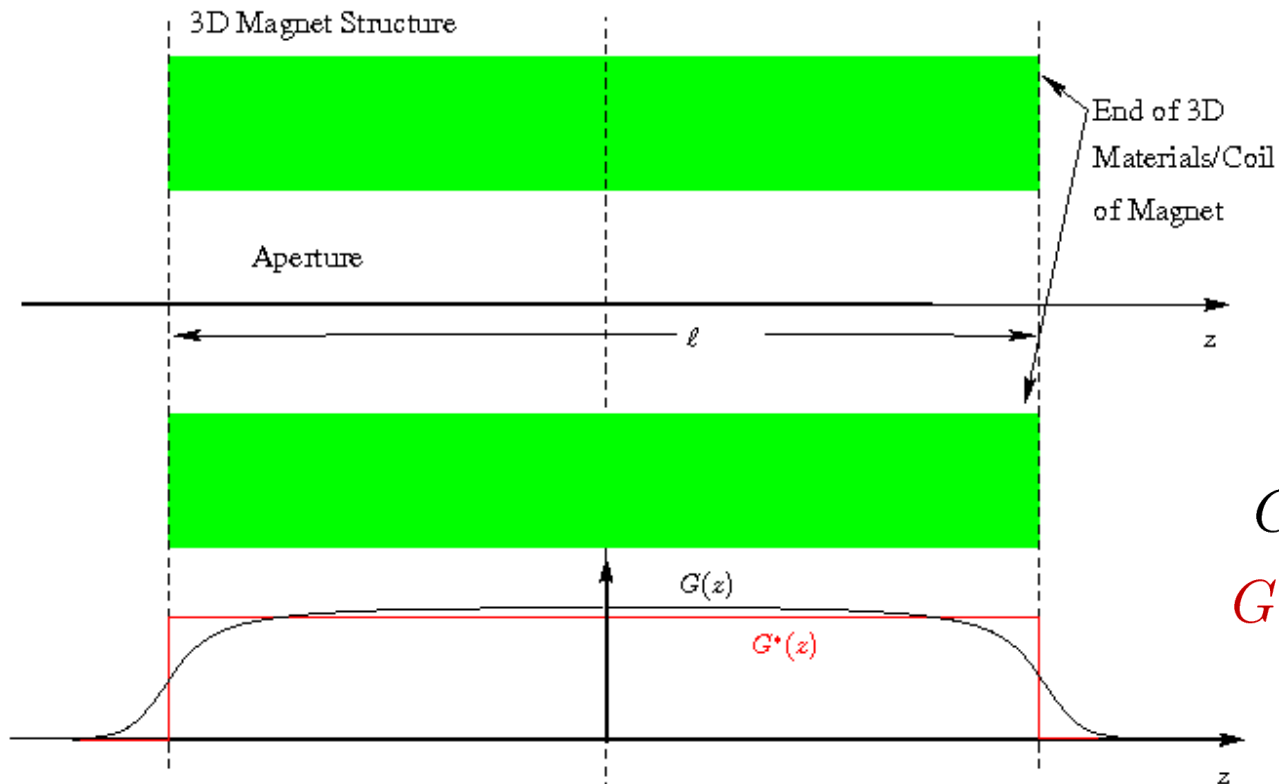

$G(z)$ = 3D Field Gradient

$G^*(z)$ = Hard-Edge Equivalent Field Gradient

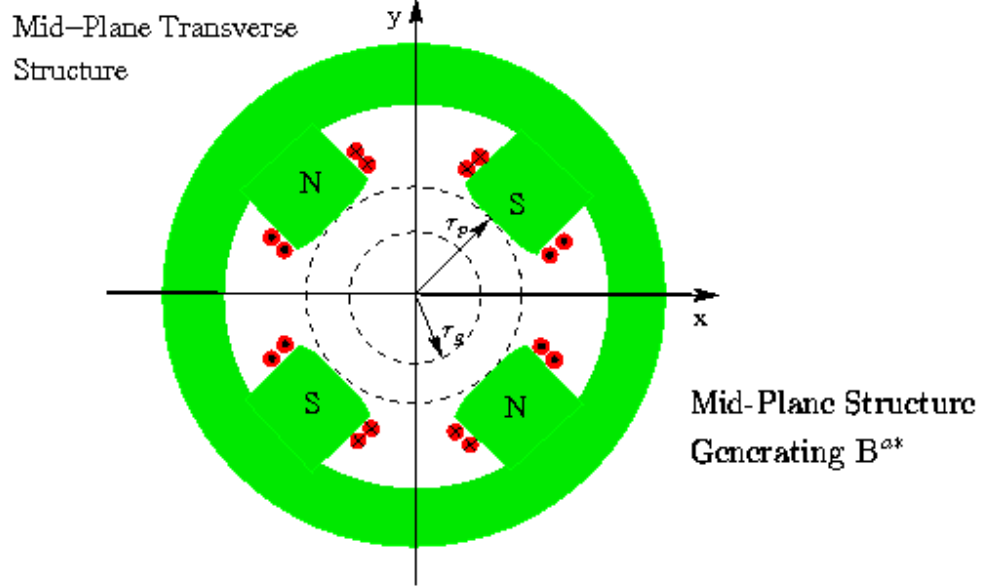

Many prescriptions exist for calculating the effective axial length and strength of hard-edge equivalent models

- ◆ See Review: Lund and Bukh, PRSTAB 7 204801 (2004), Appendix C

Here we overview a simple equivalence method that has been shown to work well:

For a relatively long, but finite axial length magnet with 3D gradient function:

$$G(z) \equiv \left. \frac{\partial B_x^a}{\partial y} \right|_{x=y=0}$$

Take **hard-edge equivalent** parameters:

- ◆ Take $z = 0$ at the axial magnet mid-plane

Gradient: $G^* \equiv G(z = 0)$

Axial Length: $\ell \equiv \frac{1}{G(z = 0)} \int_{-\infty}^{\infty} dz G(z)$

- ◆ More advanced equivalences can be made based more on particle optics
 - Disadvantage of such methods is “equivalence” changes with particle energy and must be revisited as optics are tuned

S3D: 2D Transverse Multipole Magnetic Fields

In many cases, it is sufficient to characterize the field errors in 2D hard-edge equivalent as:

$$\overline{B}_x(x, y) = \frac{1}{\ell} \int_{-\infty}^{\infty} dz B_x^a(x, y, z)$$

$$\overline{B}_y(x, y) = \frac{1}{\ell} \int_{-\infty}^{\infty} dz B_y^a(x, y, z)$$

↑
↑
 2D Effective Fields 3D Fields

Operating on the vacuum Maxwell equations with: $\int_{-\infty}^{\infty} \frac{dz}{\ell} \dots$
 yields the (exact) 2D Transverse Maxwell equations :

$$\frac{\partial \overline{B}_x(x, y)}{\partial y} = \frac{\partial \overline{B}_y(x, y)}{\partial x} \quad \Leftarrow \text{From } \nabla \times \mathbf{B} = 0$$

$$\frac{\partial \overline{B}_x(x, y)}{\partial x} = -\frac{\partial \overline{B}_y(x, y)}{\partial y} \quad \Leftarrow \text{From } \nabla \cdot \mathbf{B} = 0$$

These equations are recognized as the **Cauchy-Riemann conditions** for a **complex field variable**:

$$\underline{B}^* \equiv \overline{B_x} - i\overline{B_y} \quad i \equiv \sqrt{-1}$$

to be an **analytical function** of the **complex variable**:

$$\underline{z} \equiv x + iy \quad i \equiv \sqrt{-1}$$

Notation:

Underlines denote complex variables where confusion may arise

Cauchy-Riemann Conditions

$$\underline{F} = u(x, y) + iv(x, y)$$

$$\frac{\partial u}{\partial x} = \frac{\partial v}{\partial y}$$

$$\frac{\partial u}{\partial y} = -\frac{\partial v}{\partial x}$$

→

→

2D Magnetic Field

$$u = \overline{B_x} \quad v = -\overline{B_y}$$

$$\frac{\partial \overline{B_x}(x, y)}{\partial x} = -\frac{\partial \overline{B_y}(x, y)}{\partial y}$$

$$\frac{\partial \overline{B_x}(x, y)}{\partial y} = \frac{\partial \overline{B_y}(x, y)}{\partial x}$$

$\underline{F} = u + iv$ analytic
func of $\underline{z} = x + iy$

$\underline{F} = \overline{B_x} - i\overline{B_y}$ analytic
func of $\underline{z} = x + iy$

Note the complex field which is an analytic function of $\underline{z} = x + iy$ is $\underline{B}^* = \overline{B_x} - i\overline{B_y}$ NOT $\underline{B} = \overline{B_x} + i\overline{B_y}$. This is *not* a typo and is necessary for \underline{B}^* to satisfy the Cauchy-Riemann conditions.

♦ See problem sets for illustration

It follows that $\underline{B}^*(\underline{z})$ can be analyzed using the full power of the highly developed theory of analytical functions of a complex variable.

Expand $\underline{B}^*(\underline{z})$ as a **Laurent Series** within the vacuum aperture as:

$$\underline{B}^*(\underline{z}) = \overline{B}_x(x, y) - i\overline{B}_y(x, y) = \sum_{n=1}^{\infty} \underline{b}_n \underline{z}^{n-1}$$

$$\underline{b}_n = \text{const (complex)}$$

$$n = \text{Multipole Index}$$

The \underline{b}_n are called “**multipole coefficients**” and give the structure of the field. The multipole coefficients can be resolved into real and imaginary parts as:

$$\underline{b}_n = \mathcal{A}_n - i\mathcal{B}_n$$

$\mathcal{B}_n \implies$ ”Normal” Multipoles

$\mathcal{A}_n \implies$ ”Skew” Multipoles

Some algebra identifies the polynomial **symmetries** of low-order terms as:

Cartesian projections: $\overline{B_x} - i\overline{B_y} = (\mathcal{A}_n - i\mathcal{B}_n)(x + iy)^{n-1}$

Index n	Name	Normal ($\mathcal{A}_n = 0$)		Skew ($\mathcal{B}_n = 0$)	
		$\overline{B_x}/\mathcal{B}_n$	$\overline{B_y}/\mathcal{B}_n$	$\overline{B_x}/\mathcal{A}_n$	$\overline{B_y}/\mathcal{A}_n$
1	Dipole	0	1	1	
2	Quadrupole	y	x	x	$-y$
3	Sextupole	$2xy$	$x^2 - y^2$	$x^2 - y^2$	$-2xy$
4	Octupole	$3x^2y - y^3$	$x^3 - 3xy^2$	$x^3 - 3xy^2$	$-3x^2y + y^3$
5	Decapole	$4x^3y - 4xy^3$	$x^4 - 6x^2y^2 + y^4$	$x^4 - 6x^2y^2 + y^4$	$-4x^3y + 4xy^3$

Comments:

- ◆ Reason for pole names most apparent from polar representation (see following pages) and sketches of the magnetic pole structure
- ◆ Caution: In so-called “US notation”, poles are labeled with index $n \rightarrow n - 1$
 - Arbitrary in 2D but US choice *not* good notation in 3D generalizations

Comments continued:

- Normal and Skew symmetries can be taken as a symmetry *definition*. But this choice makes sense for $n = 2$ quadrupole focusing terms:

$$\overline{F}_x^a = -q\beta_b c \overline{B}_y = -q\beta_b c (\mathcal{B}_2 x - \mathcal{A}_2 y)$$

$$\overline{F}_y^a = q\beta_b c \overline{B}_x = q\beta_b c (\mathcal{B}_2 y + \mathcal{A}_2 x)$$

In equations of motion:

Normal $\Rightarrow \mathcal{B}_2$: x -eqn, x -focus y -eqn, y -defocus

Skew $\Rightarrow \mathcal{A}_2$: x -eqn, y -defocus y -eqn, x -defocus

Magnetic Pole Symmetries (normal orientation):

Dipole (n=1)

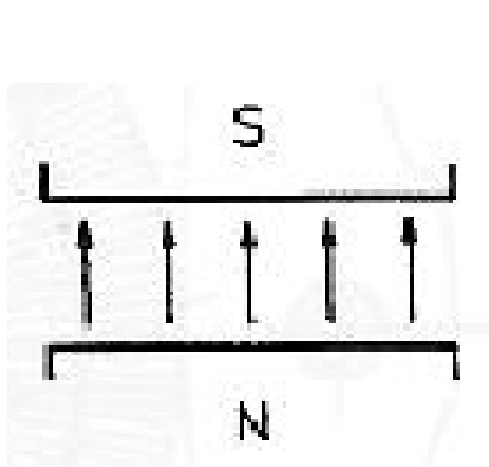

Quadrupole (n=2)

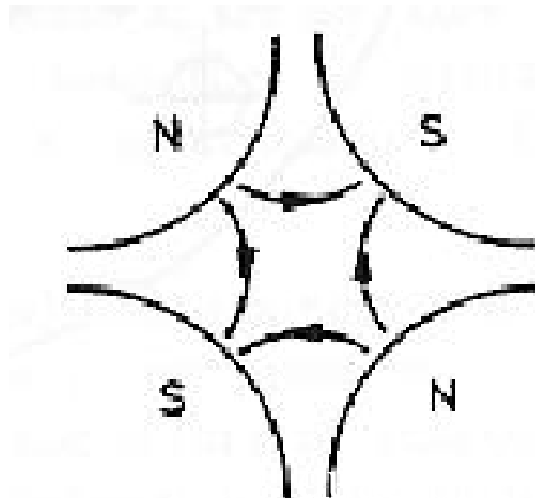

Sextupole (n=3)

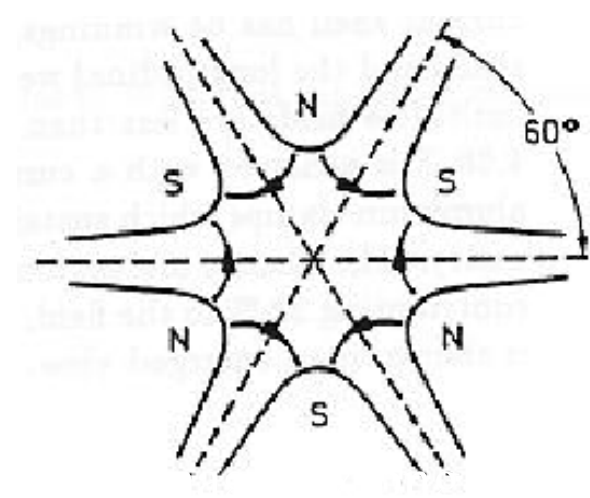

- Actively rotate normal field structures clockwise through an angle of $\pi/(2n)$ for skew field component symmetries

Multipole scale/units

Frequently, in the multipole expansion:

$$\underline{B}^*(\underline{z}) = \overline{B}_x(x, y) - i\overline{B}_y(x, y) = \sum_{n=1}^{\infty} \underline{b}_n \underline{z}^{n-1}$$

the multipole coefficients \underline{b}_n are rescaled as

$$\underline{b}_n \rightarrow \underline{b}_n r_p^{n-1}$$

r_p = Aperture "Pipe" Radius

Closest radius of approach of magnetic sources and/or aperture materials

so that the expansions becomes

$$\underline{B}^*(\underline{z}) = \overline{B}_x(x, y) - i\overline{B}_y(x, y) = \sum_{n=1}^{\infty} \underline{b}_n \left(\frac{\underline{z}}{r_p} \right)^{n-1}$$

Advantages of alternative notation:

- ◆ Multipoles \underline{b}_n given directly in field units regardless of index n
- ◆ Scaling of field amplitudes with radius within the magnet bore becomes clear

Scaling of Fields produced by multipole term:

Higher order multipole coefficients (larger n values) leading to nonlinear focusing forces decrease rapidly within the aperture. To see this use a polar representation for \underline{z} , \underline{b}_n

$$\begin{aligned}\underline{z} &= x + iy = r e^{i\theta} & r &= \sqrt{x^2 + y^2} \\ \underline{b}_n &= |\underline{b}_n| e^{i\psi_n} & \theta &= \arctan[y, x] \\ & & \psi_n &= \text{Real Const}\end{aligned}$$

Thus, the n th order multipole terms scale as

$$\underline{b}_n \left(\frac{\underline{z}}{r_p} \right)^{n-1} = |\underline{b}_n| \left(\frac{r}{r_p} \right)^{n-1} e^{i[(n-1)\theta + \psi_n]}$$

- ◆ Unless the coefficient $|\underline{b}_n|$ is very large, high order terms in n will become small rapidly as r_p decreases
- ◆ Better field quality can be obtained for a given magnet design by simply making the clear bore r_p larger, or alternatively using smaller bundles (more tight focus) of particles
 - Larger bore machines/magnets cost more. So designs become trade-off between cost and performance.
 - Stronger focusing to keep beam from aperture can be unstable (see: **S5**)

S3E: Good Field Radius

Often a magnet design will have a so-called “good-field” radius $r = r_g$ that the maximum field errors are specified on.

- ◆ In superior designs the good field radius can be around $\sim 70\%$ or more of the clear bore aperture to the beginning of material structures of the magnet.
- ◆ Beam particles should evolve with radial excursions with $r < r_g$

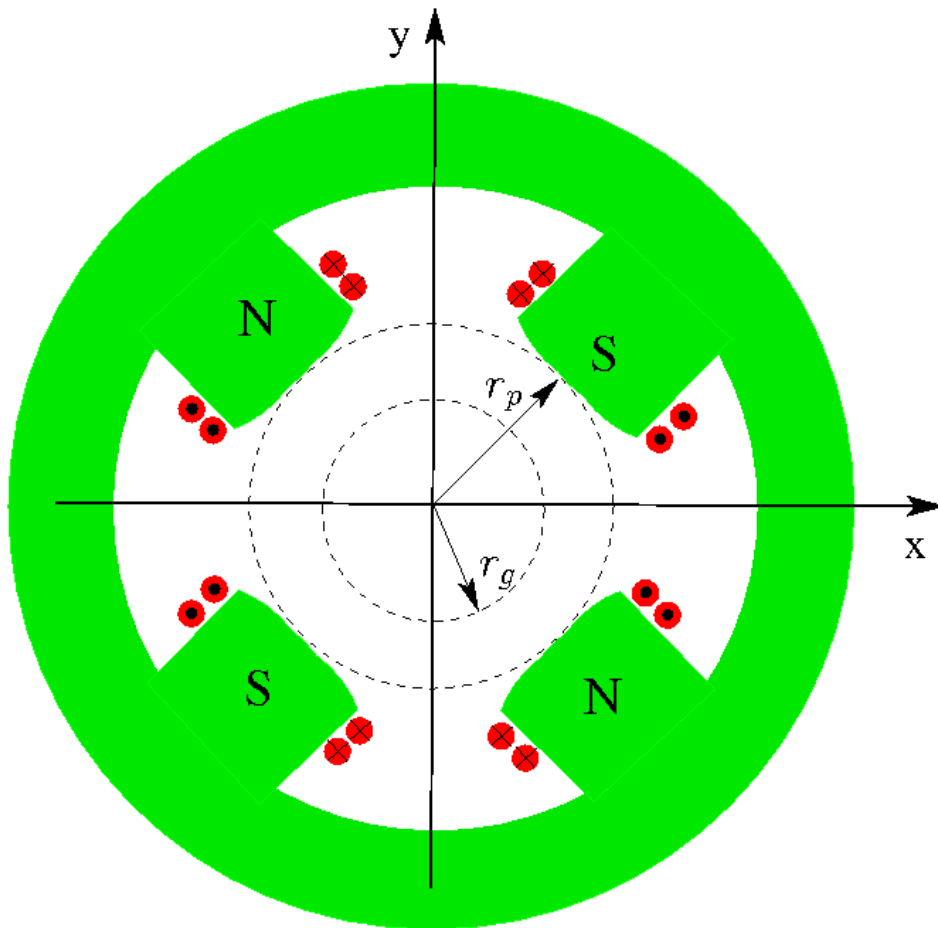

r_p = Clear Bore Radius
 \sim Pole Radius Typical

r_g = Good Field Radius
 $\sim 70\% r_p$ Typical

Comments:

- ◆ Particle orbits are designed to remain within radius r_g
- ◆ Field error statements are readily generalized to 3D since:

$$\begin{aligned} \nabla \cdot \mathbf{B}^a &= 0 \\ \nabla \times \mathbf{B}^a &= 0 \end{aligned} \quad \Longrightarrow \quad \nabla^2 \mathbf{B}^a = 0$$

and therefore each component of \mathbf{B}^a satisfies a Laplace equation within the vacuum aperture. Therefore, field errors decrease when moving more deeply within a source-free region.

S3F: Example Permanent Magnet Assemblies

A few examples of practical permanent magnet assemblies with field contours are provided to illustrate error field structures in practical devices

8 Rectangular Block Dipole 8 Square Block Quadrupole

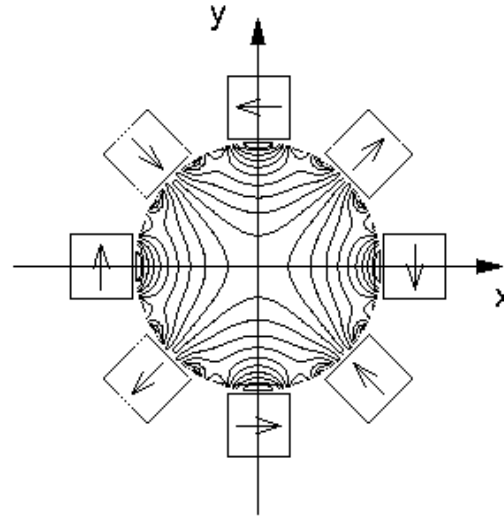
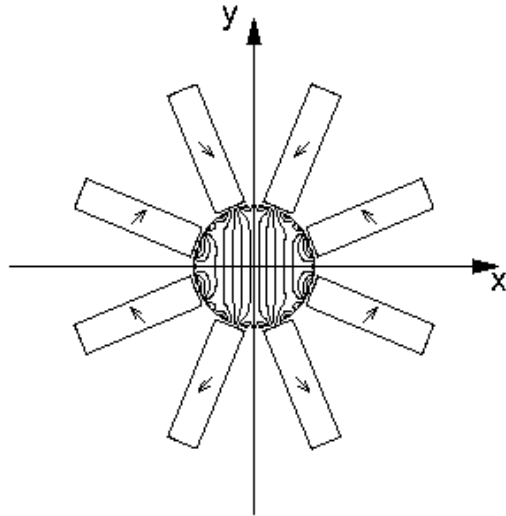

12 Rectangular Block Sextupole 8 Rectangular Block Quadrupole

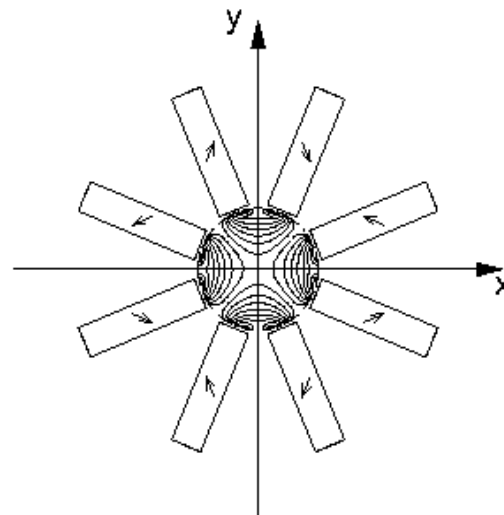
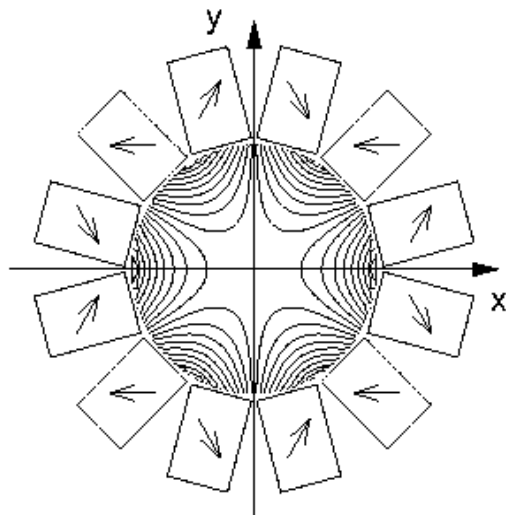

For more info on permanent magnet design see: Lund and Halbach, Fusion Engineering Design, **32-33**, 401-415 (1996)

S4: Transverse Particle Equations of Motion with Nonlinear Applied Fields

S4A: Overview

In **S1** we showed that the particle equations of motion can be expressed as:

$$\mathbf{x}''_{\perp} + \frac{(\gamma_b \beta_b)'}{(\gamma_b \beta_b)} \mathbf{x}'_{\perp} = \frac{q}{m \gamma_b \beta_b^2 c^2} \mathbf{E}_{\perp}^a + \frac{q}{m \gamma_b \beta_b c} \hat{\mathbf{z}} \times \mathbf{B}_{\perp}^a + \frac{q B_z^a}{m \gamma_b \beta_b c} \mathbf{x}'_{\perp} \times \hat{\mathbf{z}} - \frac{q}{\gamma_b^3 \beta_b^2 c^2} \frac{\partial}{\partial \mathbf{x}_{\perp}} \phi$$

When momentum spread is neglected and results are interpreted in a Cartesian coordinate system (no bends). In **S2**, we showed that these equations can be further reduced when the applied focusing fields are **linear** to:

$$x'' + \frac{(\gamma_b \beta_b)'}{(\gamma_b \beta_b)} x' + \kappa_x(s)x = -\frac{q}{m \gamma_b^3 \beta_b^2 c^2} \frac{\partial}{\partial x} \phi$$
$$y'' + \frac{(\gamma_b \beta_b)'}{(\gamma_b \beta_b)} y' + \kappa_y(s)y = -\frac{q}{m \gamma_b^3 \beta_b^2 c^2} \frac{\partial}{\partial y} \phi$$

where

$\kappa_x(s)$ = x -focusing function of lattice

$\kappa_y(s)$ = y -focusing function of lattice

describe the linear applied focusing forces and the equations are implicitly analyzed in the rotating Larmor frame when $B_z^a \neq 0$.

Lattice designs attempt to **minimize nonlinear applied fields**. However, the 3D Maxwell equations show that there will *always* be some finite nonlinear applied fields for an applied focusing element with finite extent. Applied field nonlinearities also result from:

- ◆ Design idealizations
- ◆ Fabrication and material errors

The largest source of nonlinear terms will depend on the case analyzed.

Nonlinear applied fields must be added back in the idealized model when it is appropriate to analyze their effects

- ◆ Common problem to address when carrying out large-scale numerical simulations to design/analyze systems

There are two basic approaches to carry this out:

Approach 1: Explicit 3D Formulation

Approach 2: Perturbations About Linear Applied Field Model

We will now discuss each of these in turn

S4B: Approach 1: Explicit 3D Formulation

This is the simplest. Just employ the full 3D equations of motion expressed in terms of the applied field components \mathbf{E}^a , \mathbf{B}^a and avoid using the focusing functions κ_x , κ_y

Comments:

- ◆ Most easy to apply in computer simulations where many effects are simultaneously included
 - Simplifies comparison to experiments when many details matter for high level agreement
- ◆ Simplifies simultaneous inclusion of transverse and longitudinal effects
 - Accelerating field E_z^a can be included to calculate changes in β_b , γ_b
 - Transverse and longitudinal dynamics cannot be fully decoupled in high level modeling – especially try when acceleration is strong in systems like injectors
- ◆ Can be applied with time based equations of motion (see: S1)
 - Helps avoid unit confusion and continuously adjusting complicated equations of motion to identify the axial coordinate s appropriately

S4C: Approach 2: Perturbations About Linear Applied Field Model

Exploit the linearity of the Maxwell equations to take:

$$\begin{aligned}\mathbf{E}_\perp^a &= \mathbf{E}_\perp^a|_L + \delta\mathbf{E}_\perp^a \\ \mathbf{B}^a &= \mathbf{B}^a|_L + \delta\mathbf{B}^a\end{aligned}$$

where

$\mathbf{E}_\perp^a|_L, \mathbf{B}^a|_L$ are the linear field components incorporated in κ_x, κ_y

to express the equations of motion as:

$$\begin{aligned}x'' + \frac{(\gamma_b\beta_b)'}{(\gamma_b\beta_b)}x' + \kappa_x x &= \frac{q}{m\gamma_b\beta_b^2c^2}\delta E_x^a - \frac{q}{m\gamma_b\beta_b c}\delta B_y^a + \frac{q}{m\gamma_b\beta_b c}\delta B_z^a y' \\ &\quad - \frac{q}{m\gamma_b^3\beta_b^2c^2}\frac{\partial\phi}{\partial x} \\ y'' + \frac{(\gamma_b\beta_b)'}{(\gamma_b\beta_b)}y' + \kappa_y y &= \frac{q}{m\gamma_b\beta_b^2c^2}\delta E_y^a + \frac{q}{m\gamma_b\beta_b c}\delta B_x^a - \frac{q}{m\gamma_b\beta_b c}\delta B_z^a x' \\ &\quad - \frac{q}{m\gamma_b^3\beta_b^2c^2}\frac{\partial\phi}{\partial y}\end{aligned}$$

This formulation can be most useful to understand the effect of deviations from the usual linear model where intuition is developed

Comments:

- ◆ Best suited to non-solenoidal focusing
 - Simplified Larmor frame analysis for solenoidal focusing is only valid for axisymmetric potentials $\phi = \phi(r)$ which may not hold in the presence of non-ideal perturbations.
 - Applied field perturbations $\delta\mathbf{E}_{\perp}^a$, $\delta\mathbf{B}^a$ would also need to be projected into the Larmor frame
- ◆ Applied field perturbations $\delta\mathbf{E}_{\perp}^a$, $\delta\mathbf{B}^a$ will not necessarily satisfy the 3D Maxwell Equations by themselves
 - Follows because the linear field components $\mathbf{E}_{\perp}^a|_L$, $\mathbf{B}^a|_L$ will not, in general, satisfy the 3D Maxwell equations by themselves

S5: Linear Transverse Particle Equations of Motion without Space-Charge, Acceleration, and Momentum Spread

S5A: Hill's Equation

Neglect:

- ◆ Space-charge effects: $\partial\phi/\partial\mathbf{x} \simeq 0$
- ◆ Nonlinear applied focusing and bends: $\mathbf{E}^a, \mathbf{B}^a$ have only linear focus terms
- ◆ Acceleration: $\gamma_b\beta_b \simeq \text{const}$
- ◆ Momentum spread effects: $v_{zi} \simeq \beta_b c$

Then the transverse particle equations of motion reduce to **Hill's Equation**:

$$x''(s) + \kappa(s)x(s) = 0$$

$x = \perp$ particle coordinate

(i.e., x or y or possibly combinations of coordinates)

$s =$ Axial coordinate of reference particle

$$' = \frac{d}{ds}$$

$\kappa(s) =$ Lattice focusing function (linear fields)

For a **periodic lattice**:

$$\kappa(s + L_p) = \kappa(s)$$
$$L_p = \text{Lattice Period}$$

/// Example: Hard-Edge Periodic Focusing Function

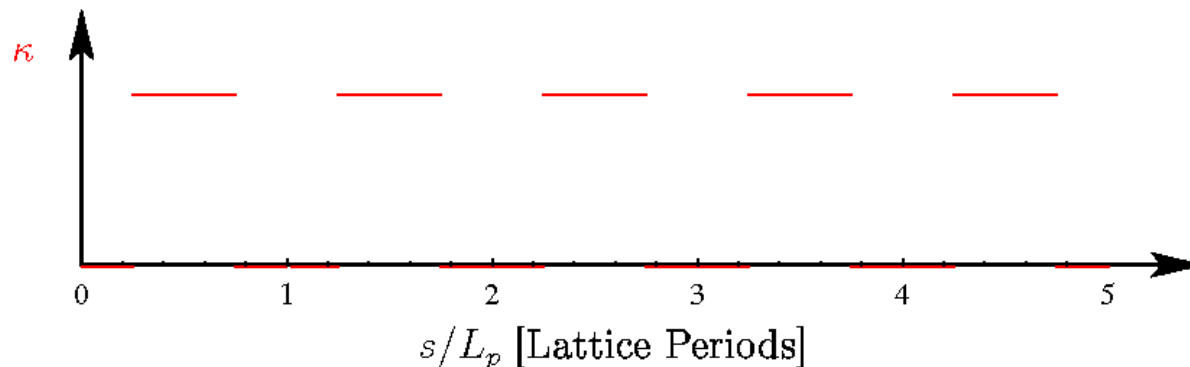

For a **ring** (i.e., circular accelerator), one also has the “superperiod” condition: ///

$$\kappa(s + \mathcal{C}) = \kappa(s)$$
$$\mathcal{C} = \mathcal{N}L_p = \text{Ring Circumfrance}$$
$$\mathcal{N} = \text{Superperiod Number}$$

- ◆ Distinction matters when there are (field) construction errors in the ring
 - Repeat with superperiod but not lattice period
 - See lectures on: **Particle Resonances**

/// Example: Period and Superperiod distinctions for errors in a ring

- * Magnet with systematic defect will be felt every lattice period
- X Magnet with random (fabrication) defect felt once per lap

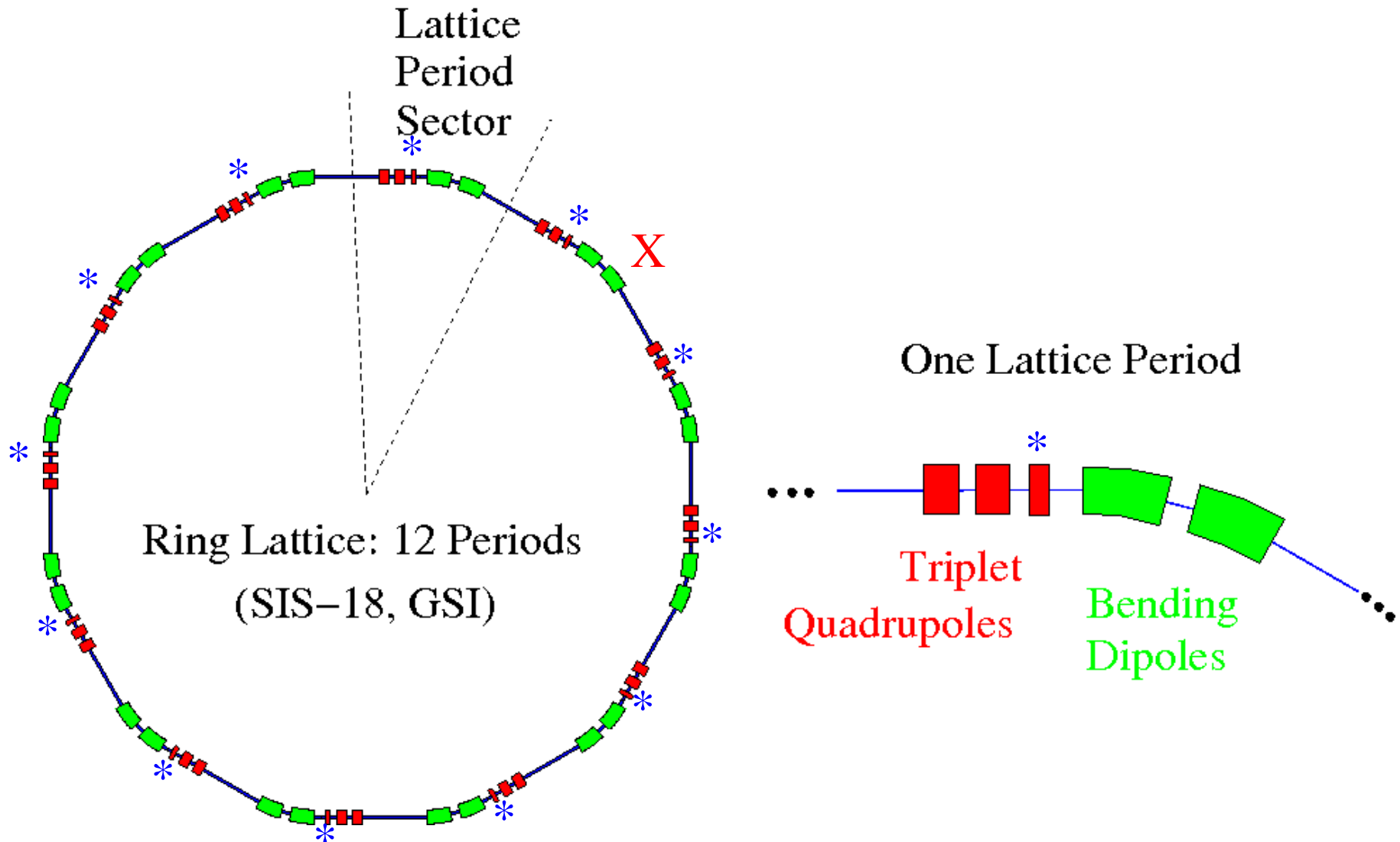

S5B: Transfer Matrix Form of the Solution to Hill's Equation

Hill's equation is linear. The solution with **initial condition**:

$$\begin{aligned}x(s = s_i) &= x(s_i) \\x'(s = s_i) &= x'(s_i)\end{aligned}$$

$s = s_i =$ Axial location
of initial condition

can be uniquely expressed in matrix form (\mathbf{M} is the **transfer matrix**) as:

$$\begin{aligned}\begin{bmatrix} x(s) \\ x'(s) \end{bmatrix} &= \mathbf{M}(s|s_i) \cdot \begin{bmatrix} x(s_i) \\ x'(s_i) \end{bmatrix} \\ &= \begin{bmatrix} C(s|s_i) & S(s|s_i) \\ C'(s|s_i) & S'(s|s_i) \end{bmatrix} \cdot \begin{bmatrix} x(s_i) \\ x'(s_i) \end{bmatrix}\end{aligned}$$

Where $C(s|s_i)$ and $S(s|s_i)$ are “cosine-like” and “sine-like” **principal trajectories** satisfying:

$$\begin{aligned}C''(s|s_i) + \kappa(s)C(s|s_i) &= 0 & C(s_i|s_i) &= 1 & C'(s_i|s_i) &= 0 \\ S''(s|s_i) + \kappa(s)S(s|s_i) &= 0 & S(s_i|s_i) &= 0 & S'(s_i|s_i) &= 1\end{aligned}$$

Transfer matrices will be worked out in the problems for a few simple focusing systems discussed in **S2** with the additional assumption of piecewise constant $\kappa(s)$

1) **Drift:** $\kappa = 0$ $x'' = 0$

$$\mathbf{M}(s|s_i) = \begin{bmatrix} 1 & s - s_i \\ 0 & 1 \end{bmatrix}$$

2) **Continuous Focusing:** $\kappa = k_{\beta 0}^2 = \text{const} > 0$ $x'' + k_{\beta 0}^2 x = 0$

$$\mathbf{M}(s|s_i) = \begin{bmatrix} \cos[k_{\beta 0}(s - s_i)] & \frac{1}{k_{\beta 0}} \sin[k_{\beta 0}(s - s_i)] \\ -k_{\beta 0} \sin[k_{\beta 0}(s - s_i)] & \cos[k_{\beta 0}(s - s_i)] \end{bmatrix}$$

3) **Solenoidal Focusing:** $\kappa = \hat{\kappa} = \text{const} > 0$ $x'' + \hat{\kappa} x = 0$

Results are expressed within the rotating **Larmor Frame**

(same as continuous focusing with reinterpretation of variables)

$$\mathbf{M}(s|s_i) = \begin{bmatrix} \cos[\sqrt{\hat{\kappa}}(s - s_i)] & \frac{1}{\sqrt{\hat{\kappa}}} \sin[\sqrt{\hat{\kappa}}(s - s_i)] \\ -\sqrt{\hat{\kappa}} \sin[\sqrt{\hat{\kappa}}(s - s_i)] & \cos[\sqrt{\hat{\kappa}}(s - s_i)] \end{bmatrix}$$

4) **Quadrupole Focusing-Plane:** $\kappa = \hat{\kappa} = \text{const} > 0$ $x'' + \hat{\kappa}x = 0$

(Obtain from continuous focusing case)

$$\mathbf{M}(s|s_i) = \begin{bmatrix} \cos[\sqrt{\hat{\kappa}}(s - s_i)] & \frac{1}{\sqrt{\hat{\kappa}}} \sin[\sqrt{\hat{\kappa}}(s - s_i)] \\ -\sqrt{\hat{\kappa}} \sin[\sqrt{\hat{\kappa}}(s - s_i)] & \cos[\sqrt{\hat{\kappa}}(s - s_i)] \end{bmatrix}$$

5) **Quadrupole DeFocusing-Plane:** $\kappa = -\hat{\kappa} = \text{const} < 0$ $x'' - \hat{\kappa}x = 0$

(Obtain from quadrupole focusing case with $\sqrt{\hat{\kappa}} \rightarrow i\sqrt{\hat{\kappa}}$ $i = \sqrt{-1}$)

$$\mathbf{M}(s|s_i) = \begin{bmatrix} \cosh[\sqrt{\hat{\kappa}}(s - s_i)] & \frac{1}{\sqrt{\hat{\kappa}}} \sinh[\sqrt{\hat{\kappa}}(s - s_i)] \\ \sqrt{\hat{\kappa}} \sinh[\sqrt{\hat{\kappa}}(s - s_i)] & \cosh[\sqrt{\hat{\kappa}}(s - s_i)] \end{bmatrix}$$

6) **Thin Lens:** $\kappa(s) = \frac{1}{f} \delta(s - s_0)$ $x'' + \frac{1}{f} \delta(s - s_0)x = 0$

$s_0 = \text{const} = \text{Axial Location Lens}$

$f = \text{const} = \text{Focal Length}$

$\delta(x) = \text{Dirac-Delta Function}$

$$\mathbf{M}(s_0^+ | s_0^-) = \begin{bmatrix} 1 & 0 \\ -\frac{1}{f} & 1 \end{bmatrix}$$

S5C: Wronskian Symmetry of Hill's Equation

An important property of this linear motion is a **Wronskian invariant/symmetry**:

$$W(s|s_i) \equiv \det \mathbf{M}(s|s_i) = \det \begin{bmatrix} C(s|s_i) & S(s|s_i) \\ C'(s|s_i) & S'(s|s_i) \end{bmatrix} \\ = C(s|s_i)S'(s|s_i) - C'(s|s_i)S(s|s_i) = 1$$

/// Proof: Abbreviate Notation $C \equiv C(s|s_i)$ etc.

Multiply Equations of Motion for C and S by $-S$ and C , respectively:

$$-S(C'' + \kappa C) = 0$$

$$+C(S'' + \kappa S) = 0$$

Add Equations:

$$CS'' - SC'' + \kappa(CS - SC) = 0$$

$$\implies \frac{dW}{ds} = \frac{d}{ds}(CS' - C'S) = CS'' - SC'' = 0$$

$$\implies W = \text{const}$$

Apply initial conditions:

$$W(s) = W(s_i) = C_i S'_i - C'_i S_i = 1 \cdot 1 - 0 \cdot 0 = 1$$

///

/// Example: Continuous Focusing: Transfer Matrix and Wronskian

$$\kappa(s) = k_{\beta 0}^2 = \text{const} > 0$$

Principal orbit equations are simple harmonic oscillators with solution:

$$\begin{aligned} C(s|s_i) &= \cos[k_{\beta 0}(s - s_i)] & C'(s|s_i) &= -k_{\beta 0} \sin[k_{\beta 0}(s - s_i)] \\ S(s|s_i) &= \frac{\sin[k_{\beta 0}(s - s_i)]}{k_{\beta 0}} & S'(s|s_i) &= \cos[k_{\beta 0}(s - s_i)] \end{aligned}$$

Transfer matrix gives the familiar solution:

$$\begin{bmatrix} x(s) \\ x'(s) \end{bmatrix} = \begin{bmatrix} \cos[k_{\beta 0}(s - s_i)] & \frac{\sin[k_{\beta 0}(s - s_i)]}{k_{\beta 0}} \\ -k_{\beta 0} \sin[k_{\beta 0}(s - s_i)] & \cos[k_{\beta 0}(s - s_i)] \end{bmatrix} \cdot \begin{bmatrix} x(s_i) \\ x'(s_i) \end{bmatrix}$$

Wronskian invariant is elementary:

$$W = \cos^2[k_{\beta 0}(s - s_i)] + \sin^2[k_{\beta 0}(s - s_i)] = 1$$

///

S5D: Stability of Solutions to Hill's Equation in a Periodic Lattice

The transfer matrix must be the same in any period of the lattice:

$$\mathbf{M}(s + L_p | s_i + L_p) = \mathbf{M}(s | s_i)$$

For a propagation distance $s - s_i$ satisfying

$$NL_p \leq s - s_i \leq (N + 1)L_p \quad N = 0, 1, 2, \dots$$

the transfer matrix can be resolved as

$$\begin{aligned} \mathbf{M}(s | s_i) &= \mathbf{M}(s - NL_p | s_i) \cdot \mathbf{M}(s_i + NL_p | s_i) \\ &= \mathbf{M}(s - NL_p | s_i) \cdot [\mathbf{M}(s_i + L_p | s_i)]^N \\ &\quad \text{Residual} \qquad \qquad \qquad N \text{ Full Periods} \end{aligned}$$

For a lattice to have **stable orbits**, both $x(s)$ and $x'(s)$ should **remain bounded** on propagation through an arbitrary number N of lattice periods. This is equivalent to requiring that the **elements of \mathbf{M} remain bounded** on propagation through any number of lattice periods:

$$\mathbf{M}^N \equiv [\mathbf{M}^N_{ij}]$$

$$\lim_{N \rightarrow \infty} \left| \mathbf{M}^N_{ij} \right| < \infty \quad \implies \text{Stable Motion}$$

Clarification of stability notion: Unstable Orbit

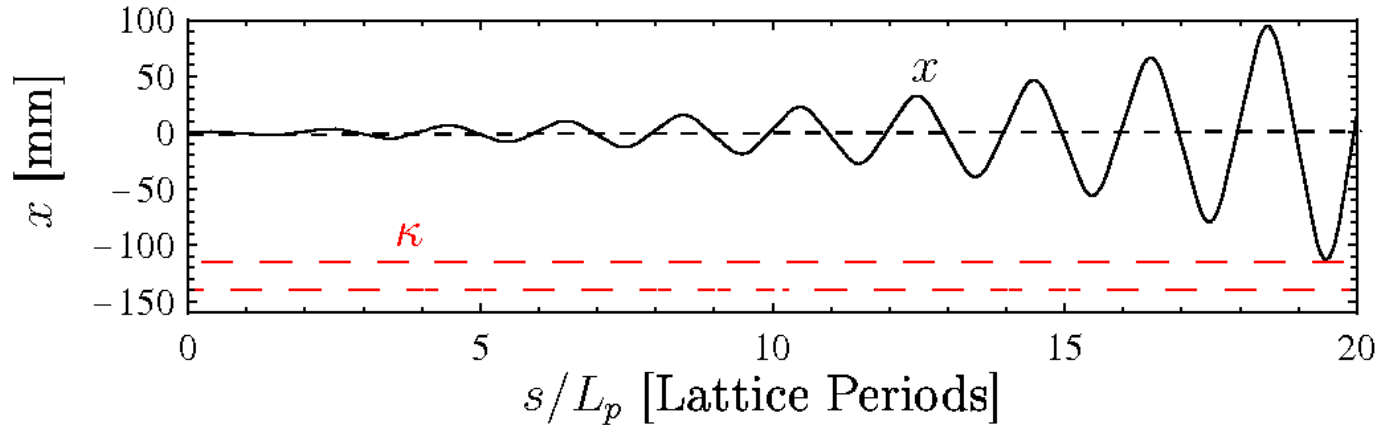

$$L_p = 0.5 \text{ m}$$

$$\eta = 0.5$$

$\kappa =$

$$\begin{cases} 48/\text{m}^2 & \text{where } \kappa \neq 0 \\ 0 & \text{otherwise} \end{cases}$$

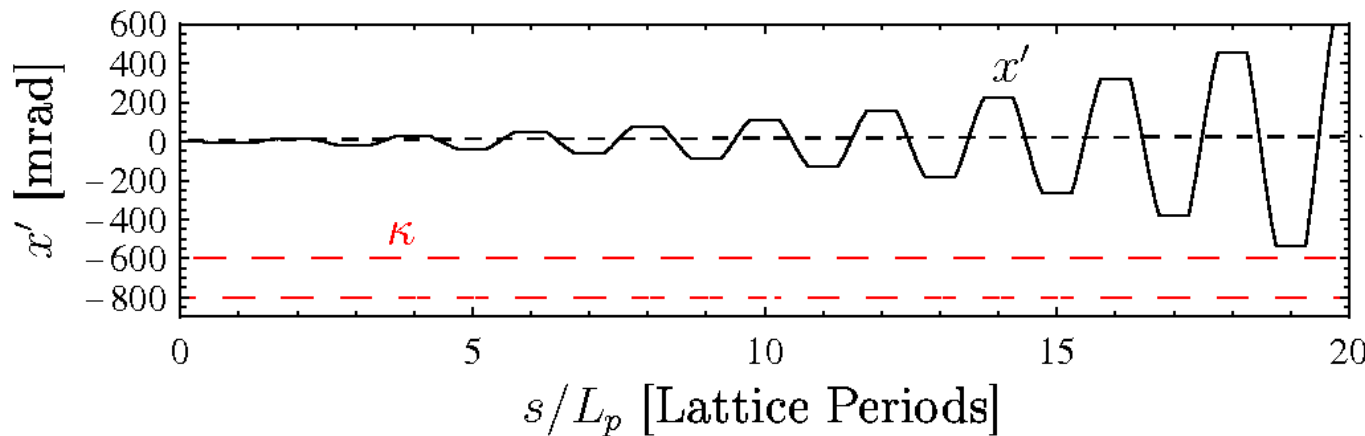

$$x(0) = 1 \text{ mm}$$

$$x'(0) = 0$$

For energetic particle: $H = \frac{1}{2}x'^2 + \frac{1}{2}\kappa x^2 \sim \text{Large, but } \neq \text{const}$

where $|x'|$ small, $|x|$ large

where $|x|$ small, $|x'|$ large

The matrix criterion corresponds to our intuitive notion of stability: as the particle advances there are no large oscillation excursions in position and angle.

To analyze the **stability condition**, examine the **eigenvectors/eigenvalues** of **M** for transport through one lattice period:

$$\mathbf{M}(s_i + L_p | s_i) \cdot \mathbf{E} \equiv \lambda \mathbf{E}$$

\mathbf{E} = Eigenvector

λ = Eigenvalue

- ◆ Eigenvectors and Eigenvalues are generally complex
- ◆ Eigenvectors and Eigenvalues generally vary with s_i
- ◆ Two independent Eigenvalues and Eigenvectors
 - Degeneracies special case

Derive the two independent eigenvectors/eigenvalues through analysis of the **characteristic equation**: Abbreviate Notation

$$\mathbf{M}(s_i + L_p | s_i) = \begin{bmatrix} C(s_i + L_p | s_i) & S(s_i + L_p | s_i) \\ C'(s_i + L_p | s_i) & S'(s_i + L_p | s_i) \end{bmatrix} \equiv \begin{bmatrix} C & S \\ C' & S' \end{bmatrix}$$

Nontrivial solutions exist when:

$$\det \begin{bmatrix} C - \lambda & S \\ C' & S' - \lambda \end{bmatrix} = \lambda^2 - (C + S')\lambda + (CS' - SC') = 0$$

But we can apply the **Wronskian** condition:

$$CS' - SC' = 1$$

and we make the notational definition

$$C + S' = \text{Tr } \mathbf{M} \equiv 2 \cos \sigma_0$$

The **characteristic equation** then reduces to:

$$\lambda^2 - 2\lambda \cos \sigma_0 + 1 = 0 \quad \cos \sigma_0 \equiv \frac{1}{2} \text{Tr } \mathbf{M}(s_i + L_p | s_i)$$

The use of $2 \cos \sigma_0$ to denote $\text{Tr } \mathbf{M}$ is in anticipation of later results (see **S6**) where σ_0 is identified as the phase-advance of a stable orbit

There are two solutions to the characteristic equation that we denote λ_{\pm}

$$\lambda_{\pm} = \cos \sigma_0 \pm \sqrt{\cos^2 \sigma_0 - 1} = \cos \sigma_0 \pm i \sin \sigma_0 = e^{\pm i \sigma_0}$$

$$\mathbf{E}_{\pm} = \text{Corresponding Eigenvectors} \quad i \equiv \sqrt{-1}$$

Note that:

$$\lambda_+ \lambda_- = 1$$
$$\lambda_+ = 1/\lambda_-$$

Consider a vector of **initial conditions**:

$$\begin{bmatrix} x(s_i) \\ x'(s_i) \end{bmatrix} = \begin{bmatrix} x_i \\ x'_i \end{bmatrix}$$

The eigenvectors \mathbf{E}_{\pm} span two-dimensional space. So any initial condition vector can be expanded as:

$$\begin{bmatrix} x_i \\ x'_i \end{bmatrix} = \alpha_+ \mathbf{E}_+ + \alpha_- \mathbf{E}_- \\ \alpha_{\pm} = \text{Complex Constants}$$

Then using $\mathbf{M}\mathbf{E}_{\pm} = \lambda_{\pm}\mathbf{E}_{\pm}$

$$\mathbf{M}^N(s_i + L_p | s_i) \begin{bmatrix} x_i \\ x'_i \end{bmatrix} = \alpha_+ \lambda_+^N \mathbf{E}_+ + \alpha_- \lambda_-^N \mathbf{E}_-$$

Therefore, if $\lim_{N \rightarrow \infty} \lambda^N$ is bounded, then the motion is **stable**. This will always be the case if $|\lambda_{\pm}| = |e^{\pm i\sigma_0}| \leq 1$, corresponding to σ_0 real with $|\cos \sigma_0| \leq 1$

This implies **for stability** or the orbit that we must have:

$$\begin{aligned} \frac{1}{2} |\text{Trace } \mathbf{M}(s_i + L_p | s_i)| &= \frac{1}{2} |C(s_i + L_p | s_i) + S'(s_i + L_p | s_i)| \\ &= |\cos \sigma_0| \leq 1 \end{aligned}$$

In a periodic focusing lattice, this important **stability condition** places restrictions on the lattice structure (focusing strength) that are generally interpreted in terms of **phase advance limits** (see: **S6**).

- ◆ Accelerator lattices almost always tuned for single particle stability to maintain beam control
 - Even for intense beams, beam centroid approximately obeys single particle equations of motion when image charges are negligible
- ◆ Space-charge and nonlinear applied fields can further limit particle stability
 - Resonances: see: **Particle Resonances**
 - Envelope Instability: see: **Transverse Centroid and Envelope**
 - Higher Order Instability: see: **Transverse Kinetic Stability**
- ◆ We will show (see: **S6**) that for stable orbits σ_0 can be interpreted as the phase-advance of single particle oscillations

/// Example: Continuous Focusing Stability

$$\kappa(s) = k_{\beta 0}^2 = \text{const} > 0$$

Principal orbit equations are simple harmonic oscillators with solution:

$$\begin{aligned} C(s|s_i) &= \cos[k_{\beta 0}(s - s_i)] & C'(s|s_i) &= -k_{\beta 0} \sin[k_{\beta 0}(s - s_i)] \\ S(s|s_i) &= \frac{\sin[k_{\beta 0}(s - s_i)]}{k_{\beta 0}} & S'(s|s_i) &= \cos[k_{\beta 0}(s - s_i)] \end{aligned}$$

Stability bound then gives:

$$\begin{aligned} \frac{1}{2} |\text{Trace } \mathbf{M}(s_i + L_p|s_i)| &= \frac{1}{2} |C(s_i + L_p|s_i) + S'(s_i + L_p|s_i)| \\ &= |\cos[k_{\beta 0}(s - s_i)]| \leq 1 \end{aligned}$$

- ◆ Always satisfied for real $k_{\beta 0}$
- ◆ Confirms known result using formalism: continuous focusing stable
 - Energy not pumped into or out of particle orbit

///

The simplest example of the stability criterion applied to periodic lattices will be given in the problem sets: **Stability of a periodic thin lens lattice**

- ◆ Analytically find that lattice unstable when focusing kicks sufficiently strong

More advanced treatments

◆ See: Dragt, *Lectures on Nonlinear Orbit Dynamics*, AIP Conf Proc 87 (1982) show that **symplectic 2x2 transfer matrices** associated with **Hill's Equation** have only **two possible classes of eigenvalue symmetries**:

1) Stable

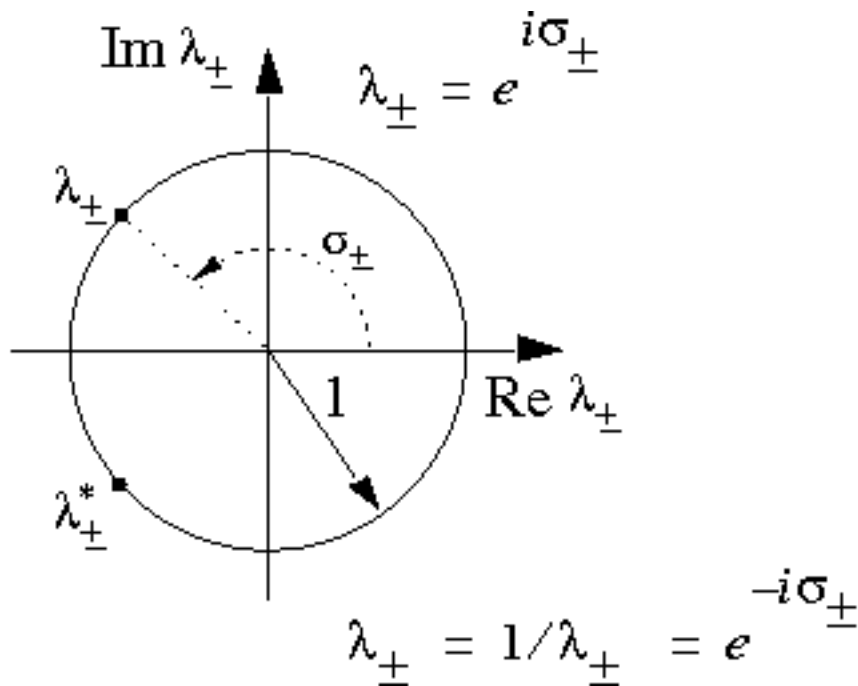

Occurs for:

$$0 \leq \sigma_0 \leq 180^\circ/\text{period}$$

◆ Limited class of possibilities simplifies analysis of focusing lattices

2) Unstable, Lattice Resonance

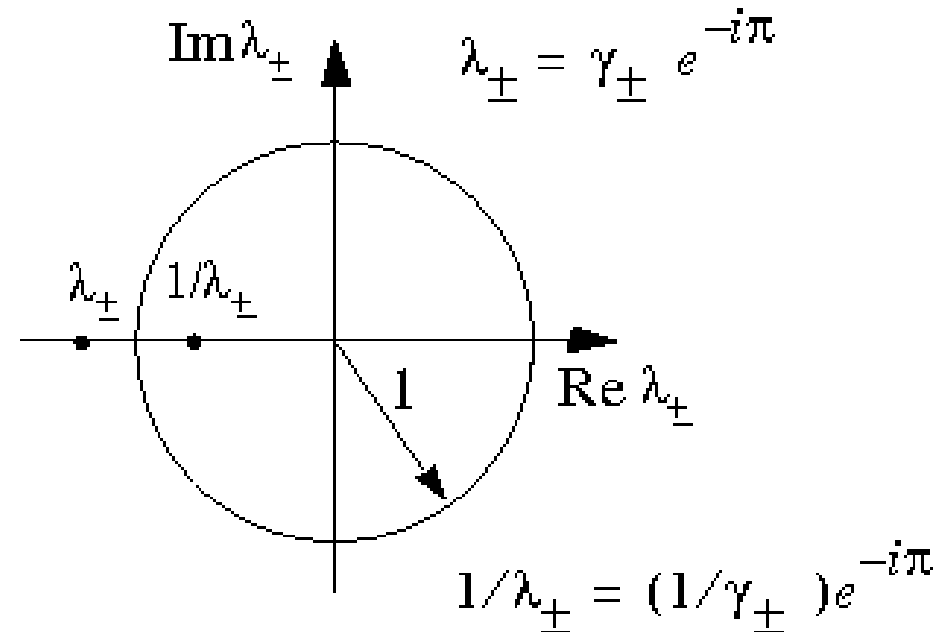

Occurs in bands when focusing strength is increased beyond

$$\sigma_0 = 180^\circ/\text{period}$$

Eigenvalue structure as focusing strength is increased

Weak Focusing:

- ◆ Make κ as small as needed (low phase advance σ_0)
- ◆ Always first eigenvalue case: $|\lambda_{\pm}| = 1$, $\lambda_+ = 1/\lambda_- = \lambda_-^*$

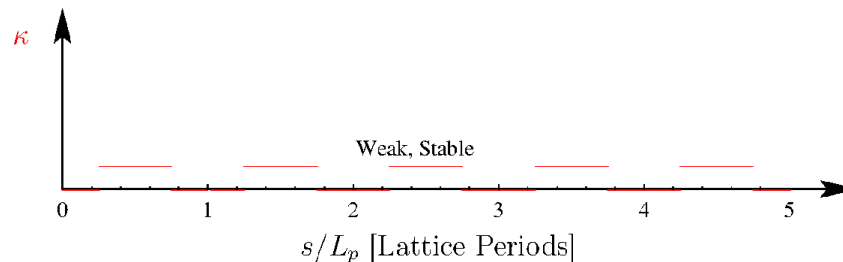
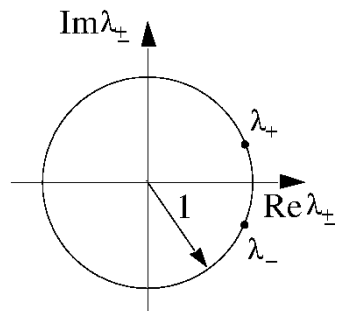

Stability Threshold:

- ◆ Increase κ to stability limit (phase advance $\sigma_0 = 180^\circ/\text{Period}$)
- ◆ Transition between first and second eigenvalue case: $\lambda_{\pm} = -1$

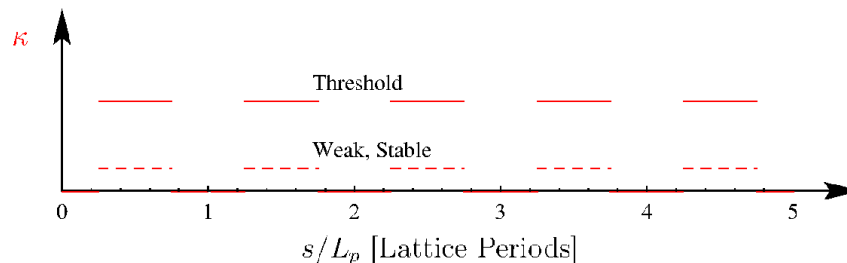
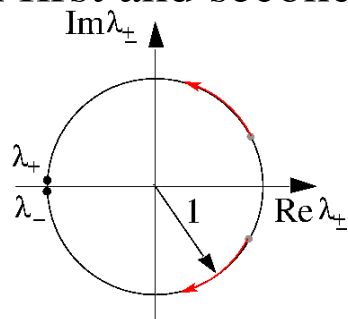

Instability:

- ◆ Increase κ beyond threshold (phase advance $\sigma_0 = 180^\circ/\text{Period}$)
- ◆ Second eigenvalue case: $|\lambda_{\pm}| \neq 1$, $\lambda_+ = 1/\lambda_-$ λ_{\pm} both real and negative

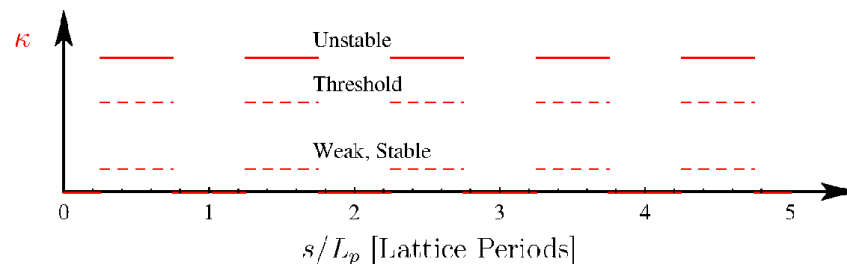
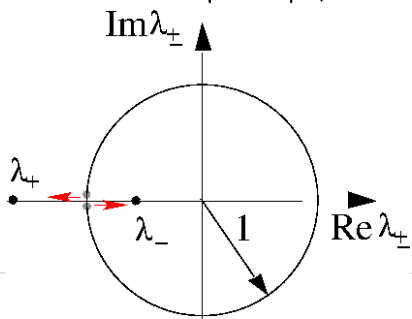

Comments:

- ◆ As κ becomes stronger and stronger it is not necessarily the case that instability persists. There can be (typically) narrow ranges of stability within a mostly unstable range of parameters.
 - Example: Stability/instability bands of the Mathieu equation commonly studied in mathematical physics which is a special case of Hills' equation.
- ◆ Higher order regions of stability past the first instability band likely make little sense to exploit because they require higher field strength (to generate larger κ) and generally lead to larger particle oscillations than for weaker fields below the first stability threshold.

S6: Hill's Equation: Floquet's Theorem and the Phase-Amplitude Form of the Particle Orbit

S6A: Introduction

In this section we consider **Hill's Equation**:

$$x''(s) + \kappa(s)x(s) = 0$$

subject to a **periodic** applied focusing function

$$\kappa(s + L_p) = \kappa(s)$$

$$L_p = \text{Lattice Period}$$

- ♦ Many results will also hold in more complicated form for a non-periodic $\kappa(s)$
 - Results less clean in this case
(initial conditions not removable to same degree as periodic case)

S6B: Floquet's Theorem

Floquet's Theorem (proof: see standard Mathematics and Mathematical Physics Texts)

The solution to Hill's Equation $x(s)$ has two linearly independent solutions that can be expressed as:

$$x_1(s) = w(s)e^{i\mu s}$$

$$x_2(s) = w(s)e^{-i\mu s}$$

$$i = \sqrt{-1}$$

$$\mu = \frac{1}{2} \text{Tr } \mathbf{M}(s_i + L_p | s_i) = \cos \sigma_0$$

$$= \text{const} = \text{Characteristic Exponent}$$

Where $w(s)$ is a **periodic** function:

$$w(s + L_p) = w(s)$$

- ◆ Theorem as written only applies for \mathbf{M} with non-degenerate eigenvalues. But a similar theorem applies in the degenerate case.
- ◆ A similar theorem is also valid for non-periodic focusing functions
 - Expression not as simple but has analogous form

S6C: Phase-Amplitude Form of Particle Orbit

As a consequence of [Floquet's Theorem](#), any (stable or unstable) nondegenerate solution to [Hill's Equation](#) can be expressed in [phase-amplitude](#) form as:

$$\begin{aligned}x(s) &= A(s) \cos \psi(s) & A(s) &= \text{Real-Valued Amplitude Function} \\A(s + L_p) &= A(s) & \psi(s) &= \text{Real-Valued Phase Function}\end{aligned}$$

Derive equations of motion for A , ψ by taking derivatives of the phase-amplitude form for $x(s)$:

$$x = A \cos \psi$$

$$x' = A' \cos \psi - A\psi' \sin \psi$$

$$x'' = A'' \cos \psi - 2A'\psi' \sin \psi - A\psi'' \sin \psi - A\psi'^2 \cos \psi$$

then substitute in [Hill's Equation](#):

$$x'' + \kappa x = [A'' + \kappa A - A\psi'^2] \cos \psi - [2A'\psi' + A\psi''] \sin \psi = 0$$

$$x'' + \kappa x = [A'' + \kappa A - A\psi'^2] \cos \psi - [2A'\psi' + A\psi''] \sin \psi = 0$$

We are free to introduce an additional constraint between A and ψ :

- Two functions A , ψ to represent one function x allows a constraint

Choose:

Eq. (1) $2A'\psi' + A\psi'' = 0 \implies$ Coefficient of $\sin \psi$ zero

Then to satisfy Hill's Equation for all ψ , the coefficient of $\cos \psi$ must also vanish giving:

Eq. (2) $A'' + \kappa A - A\psi'^2 = 0 \implies$ Coefficient of $\cos \psi$ zero

Eq. (1) Analysis (coefficient of $\sin \psi$): $2A'\psi' + A\psi'' = 0$

Simplify:

$$2A'\psi' + A\psi'' = \frac{(A^2\psi')'}{A} = 0$$

Assume for moment:

$$A \neq 0$$

$$\implies (A^2\psi')' = 0$$

Will show later
that this assumption
met for all s

Integrate once:

$$A^2\psi' = \text{const}$$

One commonly **rescales** the amplitude $A(s)$ in terms of an auxiliary amplitude function $w(s)$:

$$A(s) = A_i w(s) \quad A_i = \text{const} = \text{Initial Amplitude}$$

such that

$$w^2\psi' \equiv 1$$

This equation can then be integrated to obtain the **phase-function** of the particle:

$$\psi(s) = \psi_i + \int_{s_i}^s \frac{d\tilde{s}}{w^2(\tilde{s})} \quad \psi_i = \text{const} = \text{Initial Phase}$$

Eq. (2) Analysis (coefficient of $\cos \psi$): $A'' + \kappa A - A\psi'^2 = 0$

With the choice of amplitude rescaling, $A = A_i w$ and $w^2 \psi' = 1$, Eq. (2) becomes:

$$w'' + \kappa w - \frac{1}{w^3} = 0$$

Floquet's theorem tells us that we are free to restrict w to be a periodic solution:

$$w(s + L_p) = w(s)$$

Reduced Expressions for x and x' :

Using $A = A_i w$ and $w^2 \psi' = 1$:

$$x = A \cos \psi$$

$$x' = A' \cos \psi - A\psi' \sin \psi$$

$$\Rightarrow \begin{aligned} x &= A_i w \cos \psi \\ x' &= A_i w' \cos \psi - \frac{A_i}{w} \sin \psi \end{aligned}$$

S6D: Summary: Phase-Amplitude Form of Solution to Hill's Eqn

$$x(s) = A_i w(s) \cos \psi(s)$$

$$A_i = \text{const} = \text{Initial Amplitude}$$

$$x'(s) = A_i w'(s) \cos \psi(s) - \frac{A_i}{w(s)} \sin \psi(s)$$

$$\psi_i = \text{const} = \text{Initial Phase}$$

where $w(s)$ and $\psi(s)$ are **amplitude-** and **phase-functions** satisfying:

Amplitude Equations

$$w''(s) + \kappa(s)w(s) - \frac{1}{w^3(s)} = 0$$

$$w(s) > 0$$

Phase Equations

$$\psi'(s) = \frac{1}{w^2(s)}$$

$$\psi(s) = \psi_i + \int_{s_i}^s \frac{d\tilde{s}}{w^2(\tilde{s})}$$

$$\psi(s) = \psi_i + \Delta\psi(s)$$

Initial ($s = s_i$) amplitudes are constrained by the particle initial conditions as:

$$x(s = s_i) = A_i w_i \cos \psi_i$$

or

$$x'(s = s_i) = A_i w'_i \cos \psi_i - \frac{A_i}{w_i} \sin \psi_i$$

$$A_i \cos \psi_i = x(s = s_i) / w_i$$

$$w_i \equiv w(s = s_i)$$

$$A_i \sin \psi_i = x(s = s_i) w'_i - x'(s = s_i) w_i$$

$$w'_i \equiv w'(s = s_i)$$

S6E: Points on the Phase-Amplitude Formulation

1) $w(s)$ can be taken as **positive definite**

$$w(s) > 0$$

/// Proof: Sign choices in w :

Let $w(s)$ be positive at some point. Then the equation:

$$w'' + \kappa w - \frac{1}{w^3} = 0$$

Insures that w can never vanish or change sign. This follows because whenever w becomes small, $w'' \simeq 1/w^3 \gg 0$ can become arbitrarily large to turn w before it reaches zero. Thus, to fix phases, we conveniently require that $w > 0$. ///

- ◆ Proof verifies assumption made in analysis that $A = A_i w \neq 0$
- ◆ Conversely, one could choose w negative and it would always remain negative for analogous reasons. This choice is *not* commonly made.
- ◆ Sign choice removes ambiguity in relating initial conditions $x(s_i), x'(s_i)$ to A_i, ψ_i

2) $w(s)$ is a **unique periodic function**

- ◆ Can be proved using a connection between w and the principal orbit functions C and S (see: **Appendix A** and **S7**)
- ◆ $w(s)$ can be regarded as a special, periodic function describing the lattice focusing function $\kappa(s)$

3) The **amplitude parameters**

$$w_i = w(s = s_i)$$

$$w'_i = w'(s_i)$$

depend *only* on the periodic lattice properties and are *independent* of the particle initial conditions $x(s_i)$, $x'(s_i)$

4) The change in phase

$$\Delta\psi(s) = \int_{s_i}^s \frac{d\tilde{s}}{w^2(\tilde{s})}$$

depends on the choice of initial condition s_i . However, the **phase-advance** through one lattice period

$$\Delta\psi(s_i + L_p) = \int_{s_i}^{s_i + L_p} \frac{d\tilde{s}}{w^2(\tilde{s})}$$

is independent of s_i since w is a periodic function with period L_p

- ◆ Will show that (see later in this section)

$$\Delta\psi(s_i + L_p) \equiv \sigma_0$$

is the undepressed phase advance of particle oscillations

5) $w(s)$ has dimensions $[[w]] = \text{Sqrt}[\text{meters}]$

- ◆ Can prove inconvenient in applications and motivates the use of an alternative “betatron” function β

$$\beta(s) \equiv w^2(s)$$

with dimension $[[\beta]] = \text{meters}$ (see: [S7](#) and [S8](#))

6) On the surface, what we have done: Transform the [linear Hill's Equation](#) to a form where a solution to [nonlinear axillary equations](#) for w and ψ are needed via the [phase-amplitude method](#) seems insane [why do it?](#)

- ◆ Method will help identify the useful Courant-Snyder invariant which will aid interpretation of the dynamics (see: [S7](#))
- ◆ Decoupling of initial conditions in the phase-amplitude method will help simplify understanding of bundles of particles in the distribution

S6F: Relation between Principal Orbit Functions and Phase-Amplitude Form Orbit Functions

The **transfer matrix** \mathbf{M} of the particle orbit can be expressed in terms of the principal orbit functions C and S as (see: **S4**):

$$\begin{bmatrix} x(s) \\ x'(s) \end{bmatrix} = \mathbf{M}(s|s_i) \cdot \begin{bmatrix} x(s_i) \\ x'(s_i) \end{bmatrix} = \begin{bmatrix} C(s|s_i) & S(s|s_i) \\ C'(s|s_i) & S'(s|s_i) \end{bmatrix} \cdot \begin{bmatrix} x(s_i) \\ x'(s_i) \end{bmatrix}$$

Use of the **phase-amplitude forms** and some algebra identifies (see problem sets):

$$\begin{aligned} C(s|s_i) &= \frac{w(s)}{w_i} \cos \Delta\psi(s) - w'_i w(s) \sin \Delta\psi(s) \\ S(s|s_i) &= w_i w(s) \sin \Delta\psi(s) \\ C'(s|s_i) &= \left(\frac{w'(s)}{w_i} - \frac{w'_i}{w(s)} \right) \cos \Delta\psi(s) - \left(\frac{1}{w_i w(s)} + w'_i w'(s) \right) \sin \Delta\psi(s) \\ S'(s|s_i) &= \frac{w_i}{w(s)} \cos \Delta\psi(s) + w_i w'(s) \sin \Delta\psi(s) \\ \Delta\psi(s) &\equiv \int_{s_i}^s \frac{d\tilde{s}}{w^2(\tilde{s})} & w_i &\equiv w(s = s_i) \\ & & w'_i &\equiv w'(s = s_i) \end{aligned}$$

/// **Aside:** Alternatively, it can be shown (see: **Appendix A**) that $w(s)$ can be related to the principal orbit functions calculated over one Lattice period by:

$$w^2(s) = \beta(s) = \sin \sigma_0 \frac{S(s|s_i)}{S(s_i + L_p|s_i)} + \frac{S(s_i + L_p|s_i)}{\sin \sigma_0} \left[C(s|s_i) + \frac{\cos \sigma_0 - C(s|s_i)}{S(s_i + L_p|s_i)} S(s|s_i) \right]^2$$

$$\sigma_0 \equiv \int_{s_i}^{s_i + L_p} \frac{d\tilde{s}}{w^2(\tilde{s})}$$

The formula for σ_0 in terms of principal orbit functions is useful:

- ◆ σ_0 (phase advance, see: **S6G**) is often specified for the lattice and the focusing function $\kappa(s)$ is tuned to achieve the specified value
- ◆ Shows that $w(s)$ can be constructed from two principal orbit integrations over one lattice period
 - Integrations must generally be done numerically for C and S
 - No root finding required for initial conditions to construct periodic $w(s)$
 - s_i can be anywhere in the lattice period and $w(s)$ will be independent of the specific choice of s_i

- ♦ The form of $w^2(s)$ suggests an underlying **Courant-Snyder Invariant** (see: **S7** and **Appendix A**)
- ♦ $w^2 = \beta$ can be applied to calculate max beam particle excursions in the absence of space-charge effects (see: **S8**)
 - Useful in machine design
 - Exploits **Courant-Snyder Invariant**

///

To Add: Lee Algebra version of evolving Courant-Snyder ellipse functions through the lattice:

$$J_2 = M \cdot J_1 \cdot \text{Inv}[M]$$

This is simpler to use than the principal orbit version presented and results in an expression only in terms of lattice functions.

S6G: Undepressed Particle Phase Advance

We can now concretely connect σ_0 for a stable orbit to the change in particle oscillation phase $\Delta\psi$ through one lattice period:

From **S5D**:

$$\cos \sigma_0 \equiv \frac{1}{2} \text{Tr } \mathbf{M}(s_i + L_p | s_i)$$

Apply the principal orbit representation of \mathbf{M}

$$\text{Tr } \mathbf{M}(s_i + L_p | s_i) = C(s_i + L_p | s_i) + S'(s_i + L_p | s_i)$$

and use the phase-amplitude identifications of C and S' calculated in **S6F**:

$$\begin{aligned} \frac{1}{2} \text{Tr } \mathbf{M}(s_i + L_p | s_i) &= \frac{1}{2} \left(\frac{w(s_i + L_p)}{w_i} + \frac{w_i}{w(s_i + L_p)} \right) \cos \Delta\psi(s_i + L_p) \\ &\quad + \frac{1}{2} (w_i w'(s_i + L_p) - w'_i w(s_i + L_p)) \sin \Delta\psi(s_i + L_p) \end{aligned}$$

By periodicity:

$$\begin{aligned} w(s_i + L_p) &= w(s_i) = w_i \\ w'(s_i + L_p) &= w'(s_i) = w'_i \end{aligned} \quad \Longrightarrow \quad \begin{aligned} \text{coefficient of } \cos \Delta\psi &= 1 \\ \text{coefficient of } \sin \Delta\psi &= 0 \end{aligned}$$

Applying these results gives:

$$\cos \sigma_0 = \cos \Delta\psi(s_i + L_p) = \frac{1}{2} \text{Tr } \mathbf{M}(s_i + L_p | s_i)$$

Thus, σ_0 is identified as the **phase advance** of a stable particle orbit through one lattice period:

$$\sigma_0 = \Delta\psi(s_i + L_p) = \int_{s_i}^{s_i + L_p} \frac{ds}{w^2(s)}$$

- ◆ Again verifies that σ_0 is independent of s_i since $w(s)$ is periodic with period L_p
- ◆ The **stability criterion** (see: **S5**)

$$\frac{1}{2} |\text{Tr } \mathbf{M}(s_i + L_p | s_i)| = |\cos \sigma_0| \leq 1$$

is concretely connected to the particle phase advance through one lattice period providing a useful physical interpretation

Consequence:

Any periodic lattice with undepressed phase advance satisfying

$$\sigma_0 < \pi / \text{period} = 180^\circ / \text{period}$$

will have stable single particle orbits.

Discussion:

The **phase advance** σ_0 is an extremely useful dimensionless measure to characterize the focusing strength of a periodic lattice. Much of conventional accelerator physics centers on focusing strength and the suppression of resonance effects. The phase advance is a natural parameter to employ in many situations to allow ready interpretation of results in a generalizable manner.

We present **phase advance formulas** for several simple classes of lattices to help build intuition on focusing strength:

- 1) Continuous Focusing
- 2) Periodic Solenoidal Focusing
- 3) Periodic Quadrupole Doublet Focusing
 - FODO Quadrupole Limit

Several of these
will be derived
in the problem sets

- ◆ Lattices analyzed as “hard-edge” with piecewise-constant $\kappa(s)$ and lattice period L_p
- ◆ Results are summarized only with derivations guided in the problem sets.

- 4) Thin Lens Limits
 - Useful for analysis of scaling properties

1) Continuous Focusing

“Lattice period” L_p is an arbitrary length for phase accumulation

$$\kappa(s) = k_{\beta 0}^2 = \text{const} > 0$$

Parameters:

L_p = Lattice Period

$k_{\beta 0}^2$ = Strength

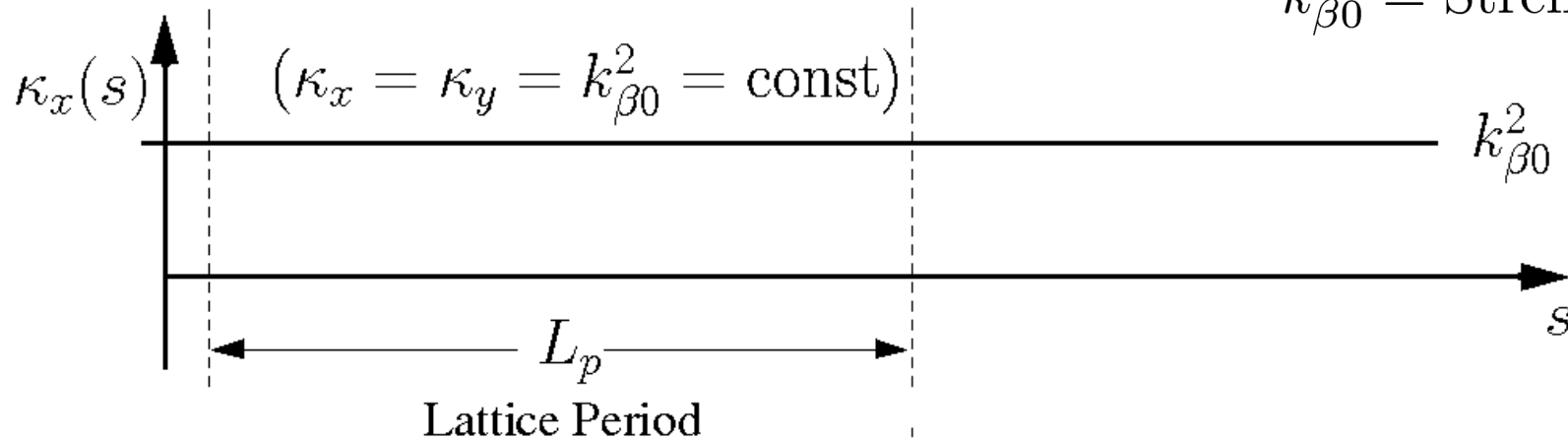

Apply phase advance formulas:

$$w'' + k_{\beta 0}^2 w - \frac{1}{w^3} = 0 \quad \Longrightarrow$$

$$w = \frac{1}{\sqrt{k_{\beta 0}}}$$

$$\sigma_0 = k_{\beta 0} L_p$$

$$\sigma_0 = \int_{s_i}^{s_i + L_p} \frac{ds}{w^2} = k_{\beta 0} L_p$$

◆ Always stable

- Energy cannot pump into or out of particle orbit

Rescaled Principal Orbit Evolution:

$$L_p = 0.5 \text{ m}$$

$$\sigma_0 = \pi/3 = 60^\circ$$

$$k_{\beta 0} = (\pi/6) \text{ rad/m}$$

Cosine-Like

1: $x(0) = 1 \text{ mm}$

$$x'(0) = 0 \text{ mrad}$$

Sine-Like

2: $x(0) = 0 \text{ mm}$

$$x'(0) = 1 \text{ mrad}$$

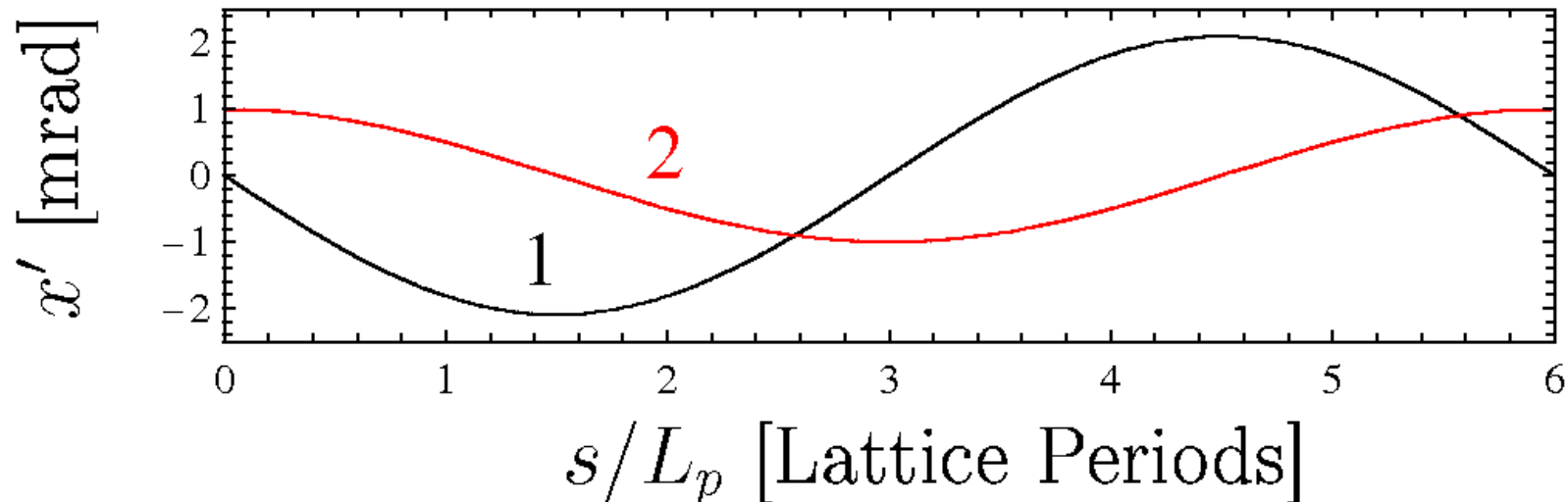
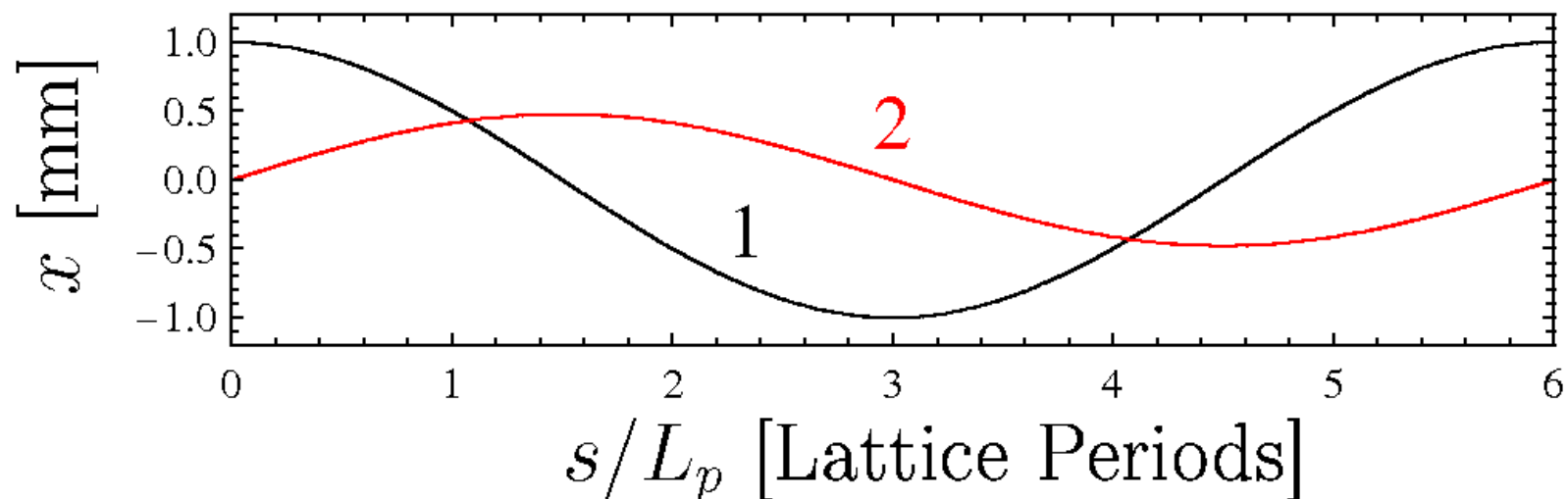

Phase-Space Evolution (see also S7):

- ◆ Phase-space ellipse stationary and aligned along x, x' axes for continuous focusing

$$w = \sqrt{1/k_{\beta 0}} = \text{const} \quad \gamma = \frac{1}{w^2} = k_{\beta 0} = \text{const}$$
$$w' = 0 \quad \alpha = -ww' = 0$$
$$\beta = w^2 = 1/k_{\beta 0} = \text{const}$$

$$k_{\beta 0}x^2 + x'^2/k_{\beta 0} = \epsilon = \text{const}$$

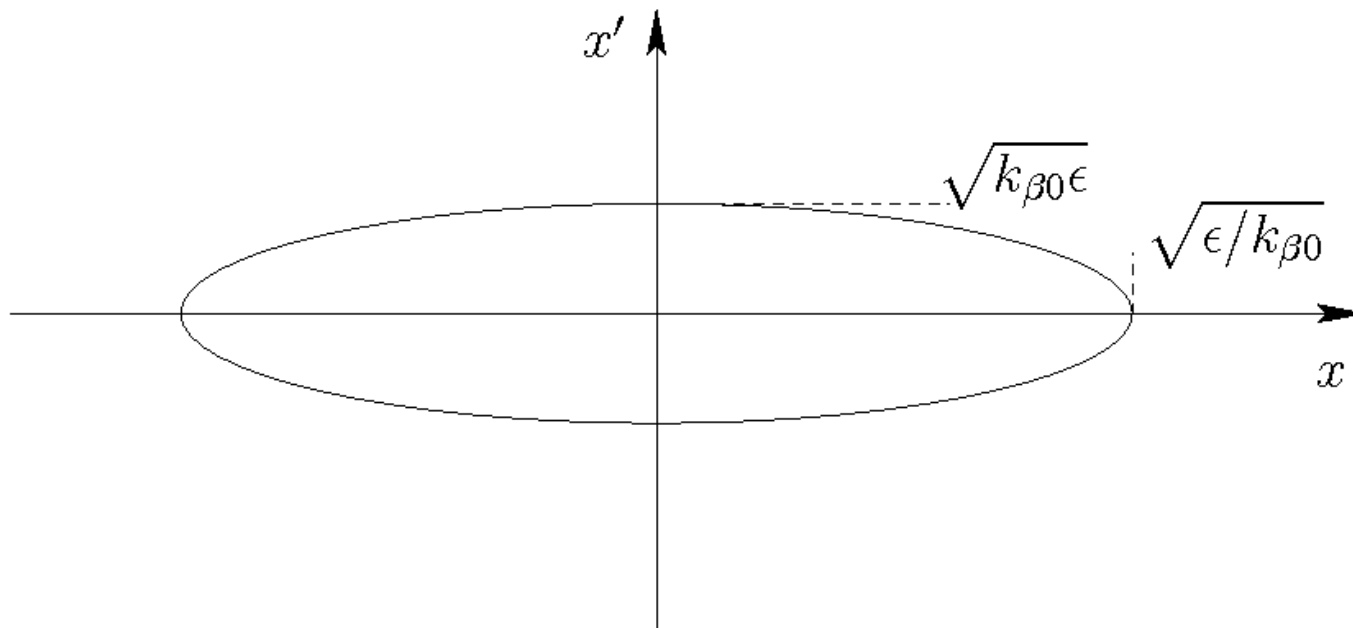

2) Periodic Solenoidal Focusing

Results are interpreted in the rotating Larmor frame (see [S2](#) and [Appendix A](#))

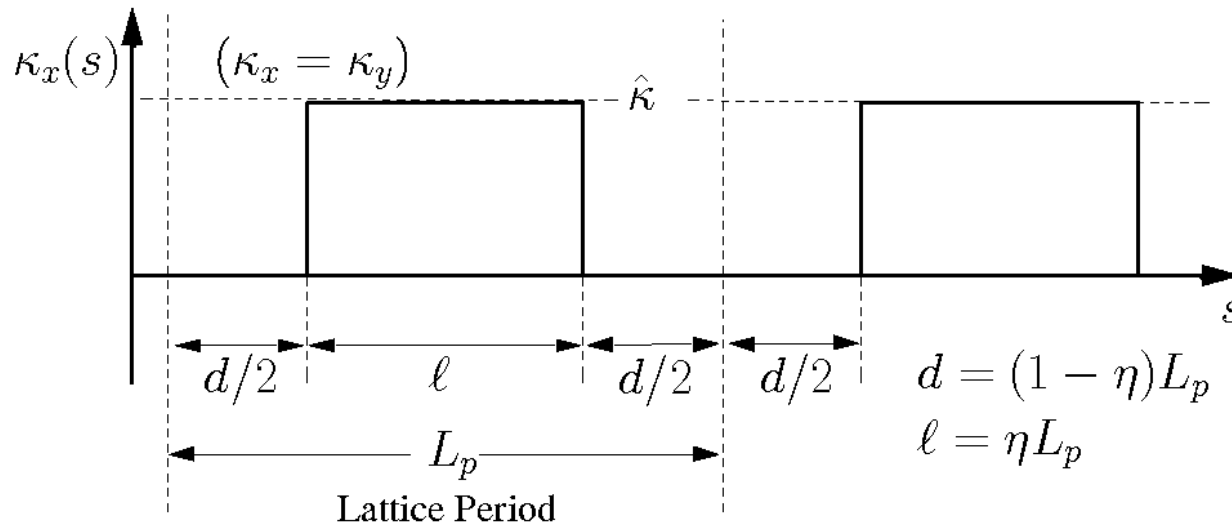

Parameters:

$\eta \in (0, 1] =$ Occupancy

$\hat{\kappa} =$ Strength

Characteristics:

$\eta L_p =$ Optic Length

$(1 - \eta)L_p =$ Drift Length

Calculation gives:

$$\cos \sigma_0 = \cos(2\Theta) - \frac{1 - \eta}{\eta} \Theta \sin(2\Theta) \quad \Theta \equiv \frac{\eta}{2} \sqrt{\hat{\kappa}} L_p$$

- ♦ Can be unstable when $\hat{\kappa}$ becomes large
 - Energy can pump into or out of particle orbit

Rescaled Larmor-Frame **Principal Orbit Evolution** Solenoid Focusing:

$$L_p = 0.5 \text{ m}$$

$$\sigma_0 = \pi/3 = 60^\circ \quad (\kappa = 8.558 \text{ m}^{-2})$$

$$\eta = 0.5$$

Cosine-Like

1: $\tilde{x}(0) = 1 \text{ mm}$

$\tilde{x}'(0) = 0 \text{ mrad}$

Sine-Like

2: $\tilde{x}(0) = 0 \text{ mm}$

$\tilde{x}'(0) = 1 \text{ mrad}$

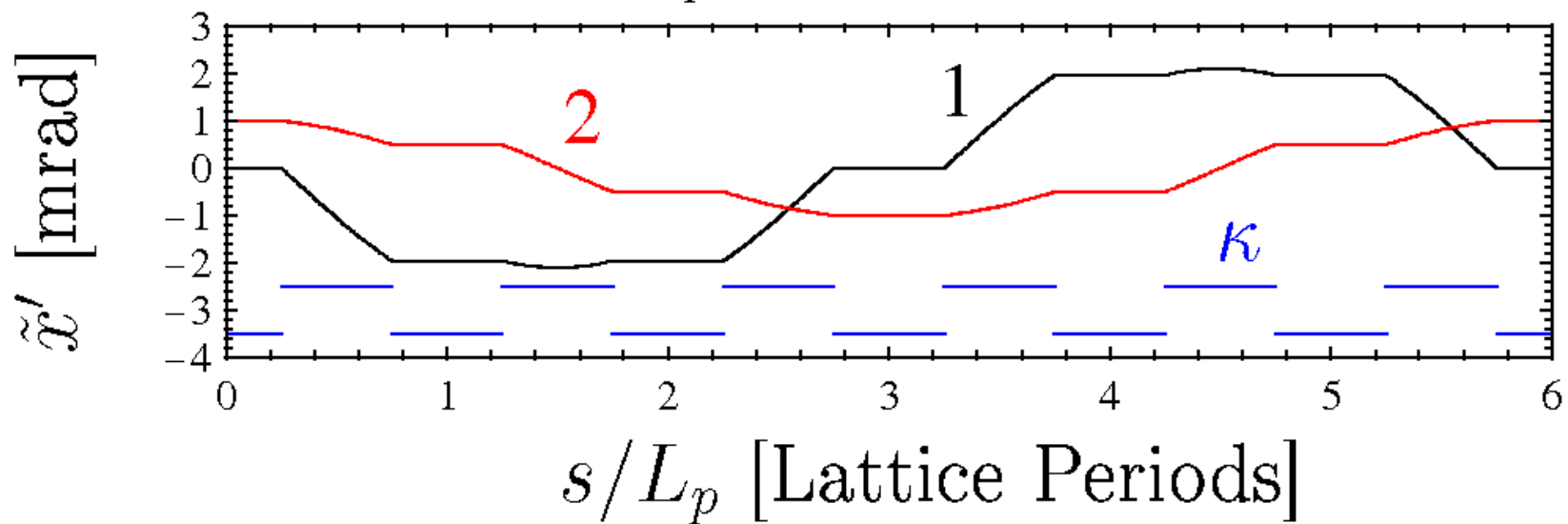
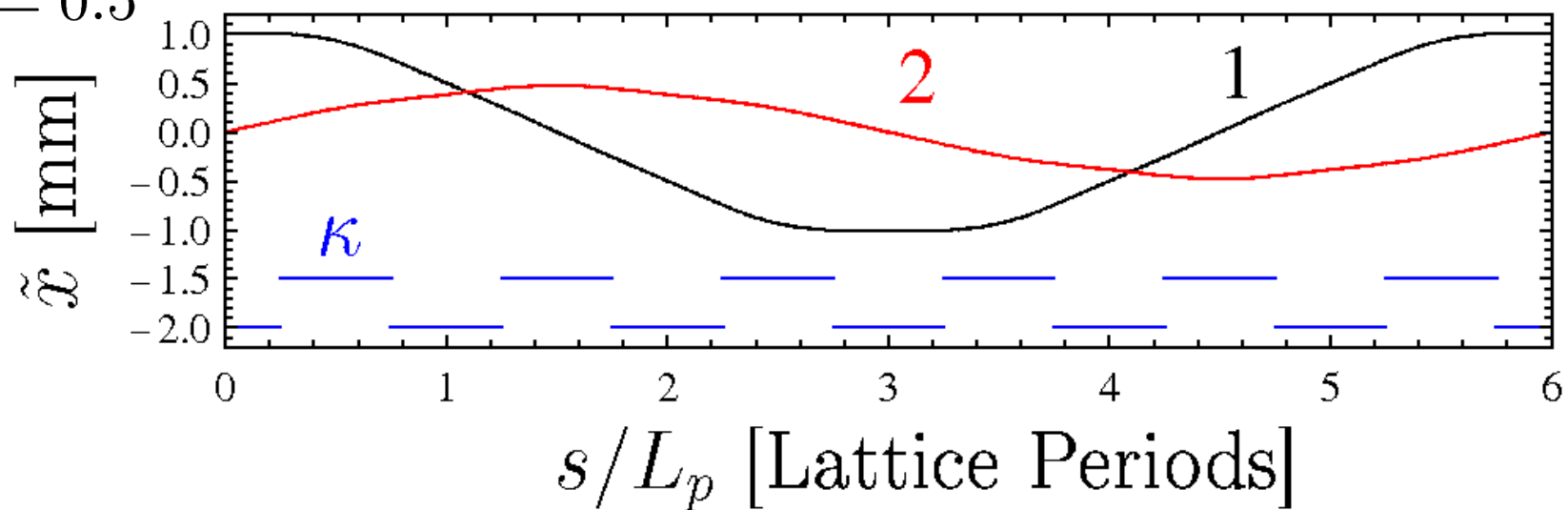

◆ Principal orbits in $\tilde{y} - \tilde{y}'$ phase-space are identical

Phase-Space Evolution in the Larmor frame (see also: S7):

- ◆ Phase-Space ellipse rotates and evolves in periodic lattice
 - phase-space properties same as in $\tilde{x} - \tilde{x}'$
 - Phase-space structure in $x-x', y-y'$ phase space is complicated

$$\gamma \tilde{x}^2 - 2\alpha \tilde{x}\tilde{x}' + \beta \tilde{x}'^2 = \epsilon = \text{const}$$

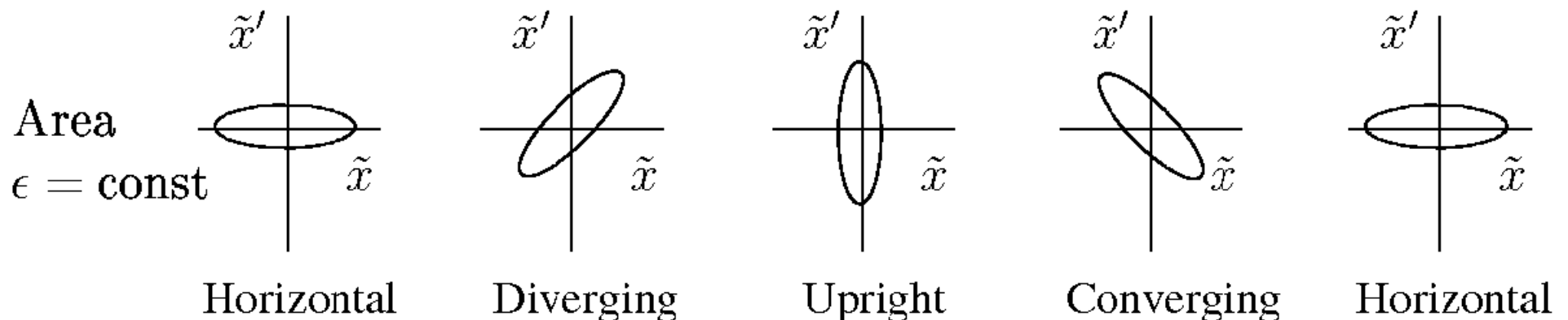
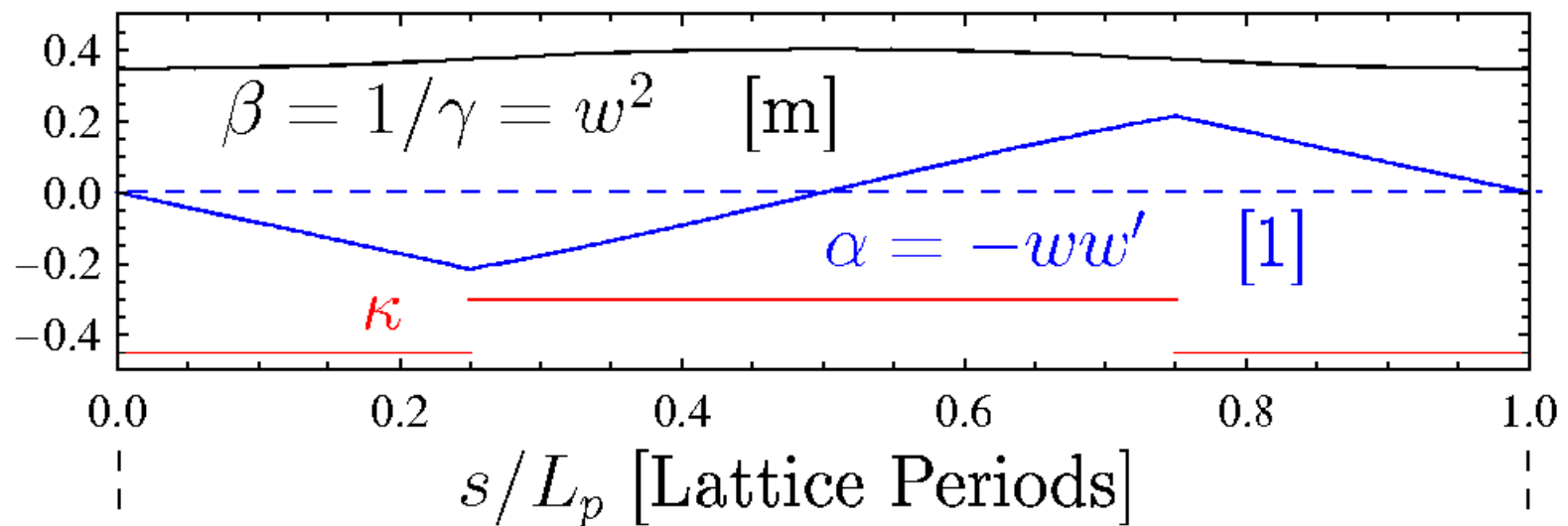

Comments on periodic solenoid results:

- ◆ Larmor frame analysis greatly simplifies results
 - 4D coupled orbit in $x-x'$, $y-y'$ phase-space will be much more intricate in structure
- ◆ Phase-Space ellipse rotates and evolves in periodic lattice
- ◆ Periodic structure of lattice changes orbits from simple harmonic

3) Periodic Quadrupole Doublet Focusing

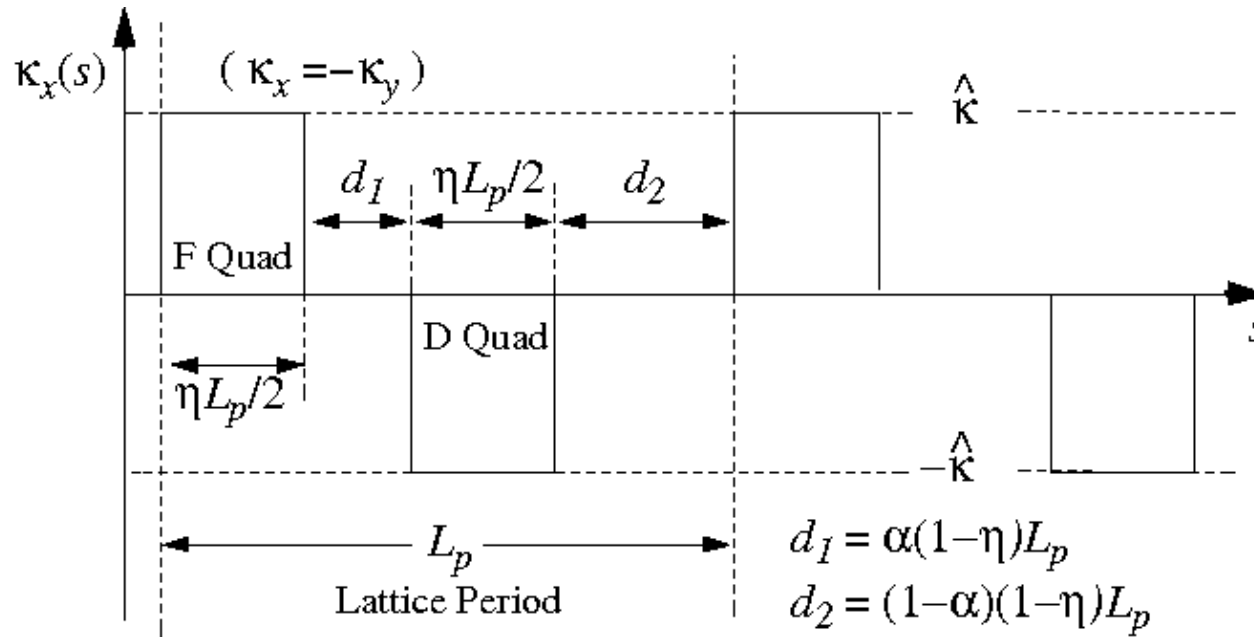

Parameters:

L_p = Lattice Period
 $\eta \in (0, 1]$ = Occupancy
 $\alpha \in [0, 1]$ = Syncopation
 $\hat{\kappa}$ = Strength

Characteristics:

$\eta L_p/2$ = F/D Len
 $\alpha(1 - \eta)L_p$ = Drift Len d_1
 $(1 - \alpha)(1 - \eta)L_p$ = Drift Len d_2

Calculation gives:

$$\begin{aligned}
 \cos \sigma_0 = & \cos \Theta \cosh \Theta + \frac{1 - \eta}{\eta} \Theta (\cos \Theta \sinh \Theta - \sin \Theta \cosh \Theta) \\
 & - 2\alpha(1 - \alpha) \frac{(1 - \eta)^2}{\eta^2} \Theta^2 \sin \Theta \sinh \Theta
 \end{aligned}
 \quad \Theta \equiv \frac{\eta}{2} \sqrt{|\hat{\kappa}|} L_p$$

- ♦ Can be unstable when $\hat{\kappa}$ becomes large
- Energy can pump into or out of particle orbit

Comments on Parameters:

- ◆ The “syncopation” parameter α measures how close the Focusing (F) and DeFocusing (D) quadrupoles are to each other in the lattice

$$\alpha \in [0, 1] \quad \begin{array}{l} \alpha = 0 \quad \Longrightarrow \quad d_1 = 0 \quad \quad d_2 = (1 - \eta)L_p \\ \alpha = 1 \quad \Longrightarrow \quad d_1 = (1 - \eta)L_p \quad d_2 = 0 \end{array}$$

The range $\alpha \in [1/2, 1]$ can be mapped to $\alpha \in [0, 1/2]$ by simply relabeling quantities. Therefore, we can take:

$$\alpha \in [0, 1/2]$$

- ◆ The special case of a doublet lattice with $\alpha = 1/2$ corresponds to equal drift lengths between the F and D quadrupoles and is called a **FODO lattice**

$$\alpha = 1/2 \quad \Longrightarrow \quad d_1 = d_2 \equiv d = (1 - \eta)L_p/2$$

Phase advance constraint will be derived for FODO case in problems (algebra much simpler than doublet case)

Special Case Doublet Focusing: Periodic Quadrupole FODO Lattice

Parameters:

$\eta \in (0, 1] =$ Occupancy

$\hat{\kappa} =$ Strength

Characteristics:

$\eta L_p/2 = \ell =$ F/D Len

$(1 - \eta)L_p/2 = d =$ Drift Len

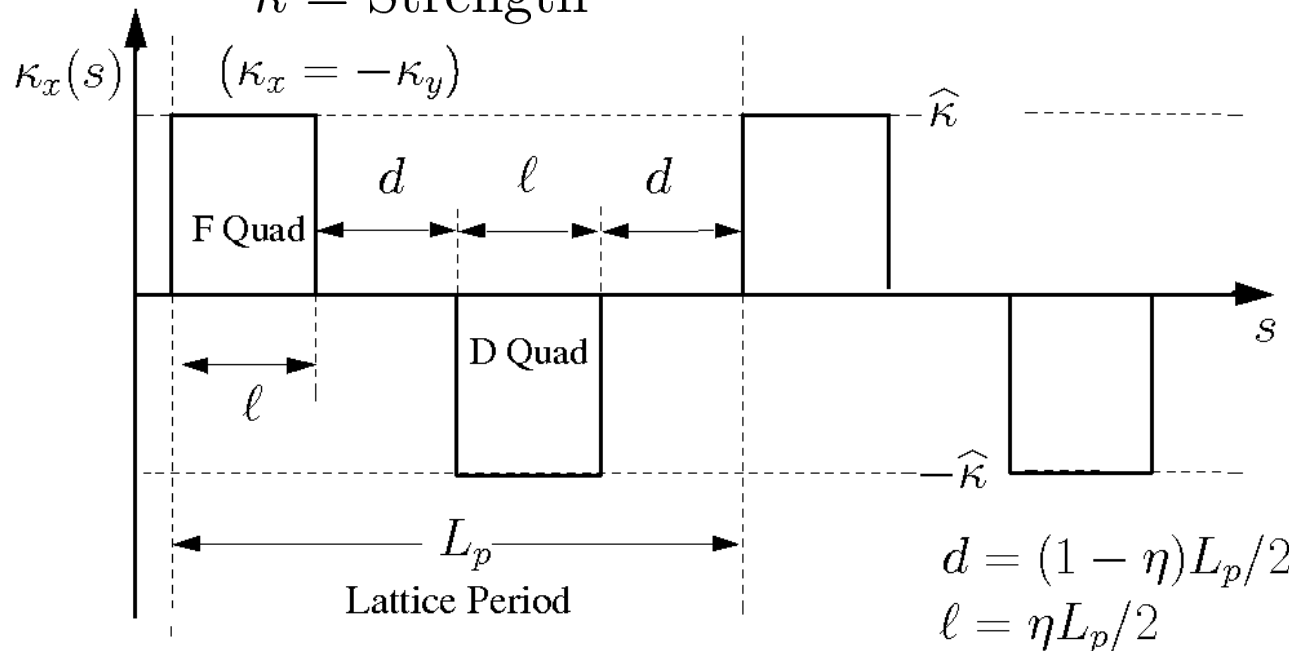

Phase advance formula reduces to:

$$\cos \sigma_0 = \cos \Theta \cosh \Theta + \frac{1 - \eta}{\eta} \Theta (\cos \Theta \sinh \Theta - \sin \Theta \cosh \Theta) - \frac{(1 - \eta)^2}{2\eta^2} \Theta^2 \sin \Theta \sinh \Theta$$

$$\Theta \equiv \frac{\eta}{2} \sqrt{|\hat{\kappa}|} L_p$$

- Analysis shows FODO provides stronger focus for same integrated field gradients than doublet due to symmetry

Rescaled Principal Orbit Evolution FODO Quadrupole:

$$L_p = 0.5 \text{ m}$$

$$\sigma_0 = \pi/3 = 60^\circ \quad (\kappa = 39.24 \text{ m}^{-2})$$

$$\eta = 0.5$$

Cosine-Like

Sine-Like

1: $x(0) = 1 \text{ mm}$
 $x'(0) = 0 \text{ mrad}$

2: $x(0) = 0 \text{ mm}$
 $x'(0) = 1 \text{ mrad}$

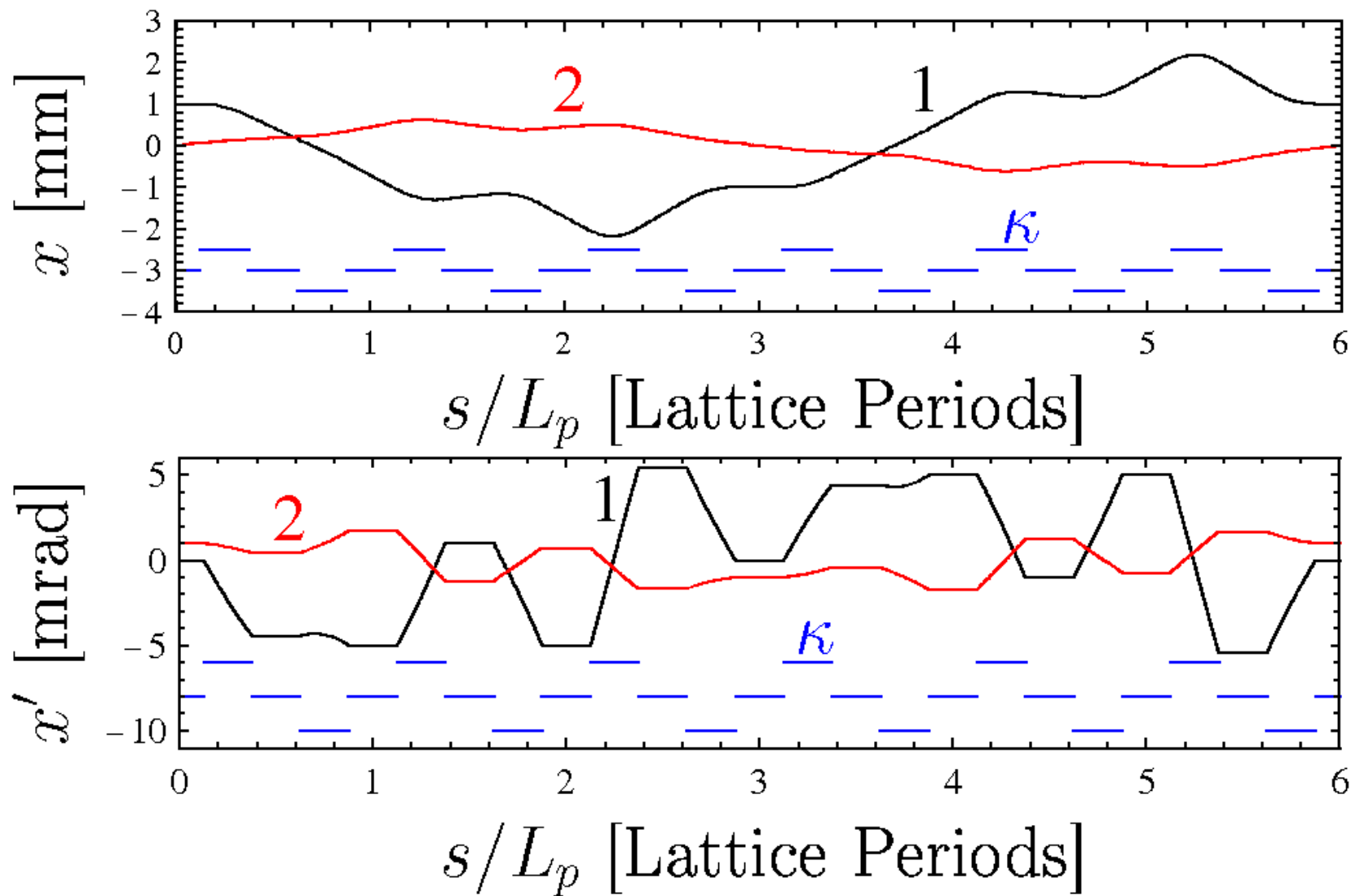

Phase-Space Evolution (see also: S7):

$$\gamma x^2 - 2\alpha x x' + \beta x'^2 = \epsilon = \text{const}$$

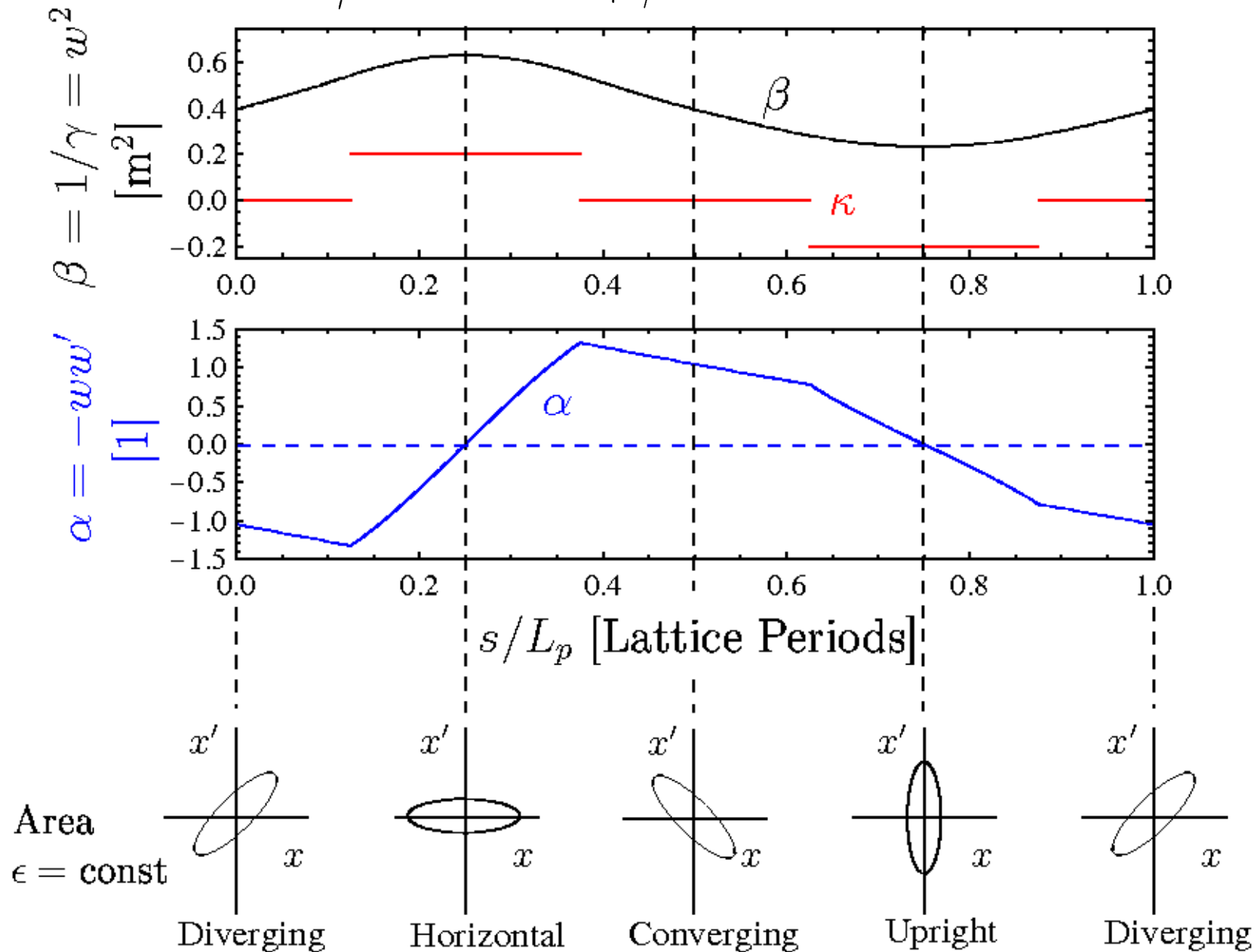

Comments on periodic FODO quadrupole results:

- ♦ Phase-Space ellipse rotates and evolves in periodic lattice
 - Evolution more intricate for Alternating Gradient (AG) focusing than for solenoidal focusing in the Larmor frame
- ♦ Harmonic content of orbits larger for AG focusing than solenoidal focusing
- ♦ Orbit and phase space evolution analogous in y - y' plane
 - Simply related by a shift in s of the lattice

Contrast of Principal Orbits for different focusing:

- ◆ Use previous examples with “equivalent” focusing strength $\sigma_0 = 60^\circ$
- ◆ Note that periodic focusing adds harmonic structure

1) Continuous Focusing

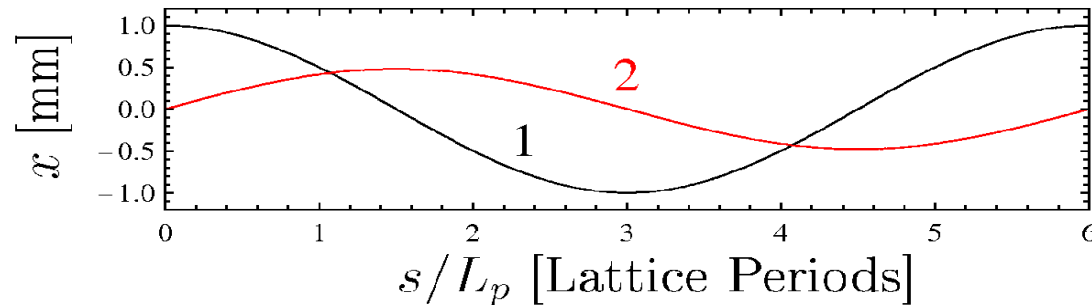

Simple Harmonic Oscillator

2) Periodic Solenoidal Focusing (Larmor Frame)

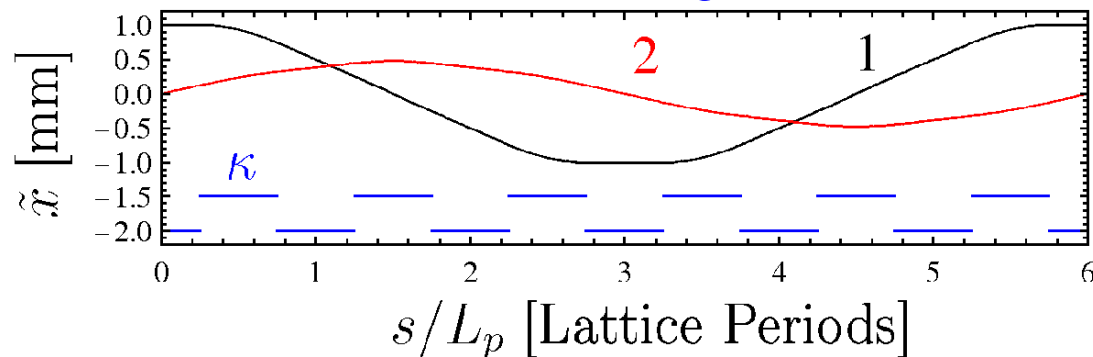

Simple harmonic oscillations modified with additional harmonics due to periodic focus

3) Periodic FODO Quadrupole Doublet Focusing

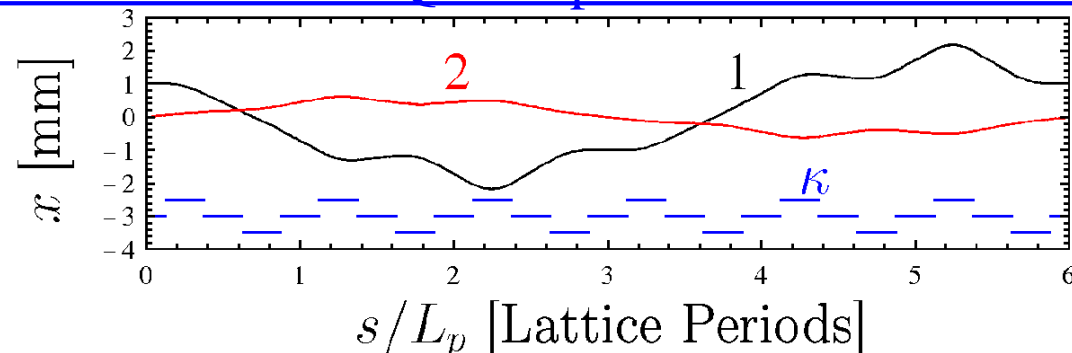

Simple harmonic oscillations more strongly modified due to periodic AG focus

4) Thin Lens Limits

Convenient to simply understand analytic scaling

$$\kappa_x(s) = \frac{1}{f} \delta(s - s_0)$$

$s_0 = \text{Optic Location} = \text{const}$

$f = \text{focal length} = \text{const}$

Transfer Matrix:

$$\begin{bmatrix} x \\ x' \end{bmatrix}_{s=s_0^+} = \begin{bmatrix} 1 & 0 \\ -1/f & 1 \end{bmatrix} \cdot \begin{bmatrix} x \\ x' \end{bmatrix}_{s=s_0^-}$$

Graphical Interpretation:

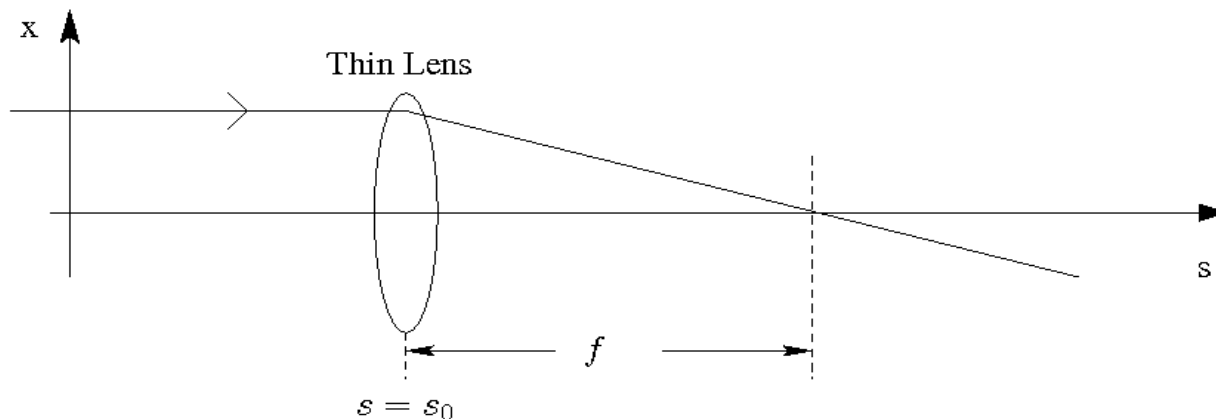

The thin lens limit of “thick” hard-edge solenoid and quadrupole focusing lattices presented can be obtained by taking:

Solenoids: $\hat{\kappa} \equiv \frac{1}{\eta f L_p}$ then take $\lim_{\eta \rightarrow 0}$

Quadrupoles: $\hat{\kappa} \equiv \frac{2}{\eta f L_p}$ then take $\lim_{\eta \rightarrow 0}$

This obtains when applied in the previous formulas:

$$\cos \sigma_0 = \begin{cases} 1 - \frac{1}{2} \frac{L_p}{f}, & \text{thin-lens periodic solenoid} \\ 1 - \frac{\alpha}{2} (1 - \alpha) \left(\frac{L_p}{f} \right)^2, & \text{thin-lens quadrupole doublet} \\ & \alpha = \frac{1}{2} \implies \text{FODO} \end{cases}$$

These formulas can also be derived directly from the drift and thin lens transfer matrices as

Periodic Solenoid

$$\cos \sigma_0 = \frac{1}{2} \text{Tr} \begin{bmatrix} 1 & L_p \\ 0 & 1 \end{bmatrix} \begin{bmatrix} 1 & 0 \\ -\frac{1}{f} & 1 \end{bmatrix} = 1 - \frac{1}{2} \frac{L_p}{f}$$

Periodic Quadrupole Doublet

$$\cos \sigma_0 = \frac{1}{2} \text{Tr} \begin{bmatrix} 1 & 0 \\ -\frac{1}{f} & 1 \end{bmatrix} \begin{bmatrix} 1 & \alpha L_p \\ 0 & 1 \end{bmatrix} \begin{bmatrix} 1 & 0 \\ \frac{1}{f} & 1 \end{bmatrix} \begin{bmatrix} 1 & (1 - \alpha)L_p \\ 0 & 1 \end{bmatrix} = 1 - \frac{\alpha}{2} (1 - \alpha) \left(\frac{L_p}{f} \right)^2$$

Expanded phase advance formulas (thin lens type limit and similar) can be useful in system design studies

- ◆ Desirable to derive simple formulas relating magnet parameters to σ_0
 - Clear analytic scaling trends clarify design trade-offs
- ◆ For hard edge periodic lattices, expand formula for $\cos \sigma_0$ to leading order in $\Theta = \sqrt{|\hat{\kappa}|} \eta L_p / 2$

/// Example: Periodic Quadrupole Doublet Focusing:

Expand previous phase advance formula for synchrotrons with periodic quadrupole doublet to obtain:

$$\cos \sigma_0 = 1 - \frac{(\eta \hat{\kappa} L_p^2)^2}{32} \left[\left(1 - \frac{2}{3} \eta \right) - 4 \left(\alpha - \frac{1}{2} \right)^2 (1 - \eta)^2 \right]$$

where:

$$\hat{\kappa} = \begin{cases} \frac{\hat{G}}{[B\rho]}, & \text{Magnetic Quadrupoles} \\ \frac{\hat{G}}{\beta_b c [B\rho]}, & \text{Electric Quadrupoles} \end{cases} \quad \hat{G} = \text{Hard-Edge Field Gradient}$$

Using these results, plot the **Field Gradient** and **Integrated Gradient** for quadrupole doublet focusing needed for $\sigma_0 = 80^\circ$ per lattice period

$$\text{Gradient} \sim |\hat{\kappa}| L_p^2 \sim \hat{G}$$

$$\text{Integrated Gradient} \sim \eta |\hat{\kappa}| L_p^2 / 2 \sim \hat{G} \ell$$

$\sigma_0 = 80^\circ$ / (Lattice Period) Quadrupole Doublet

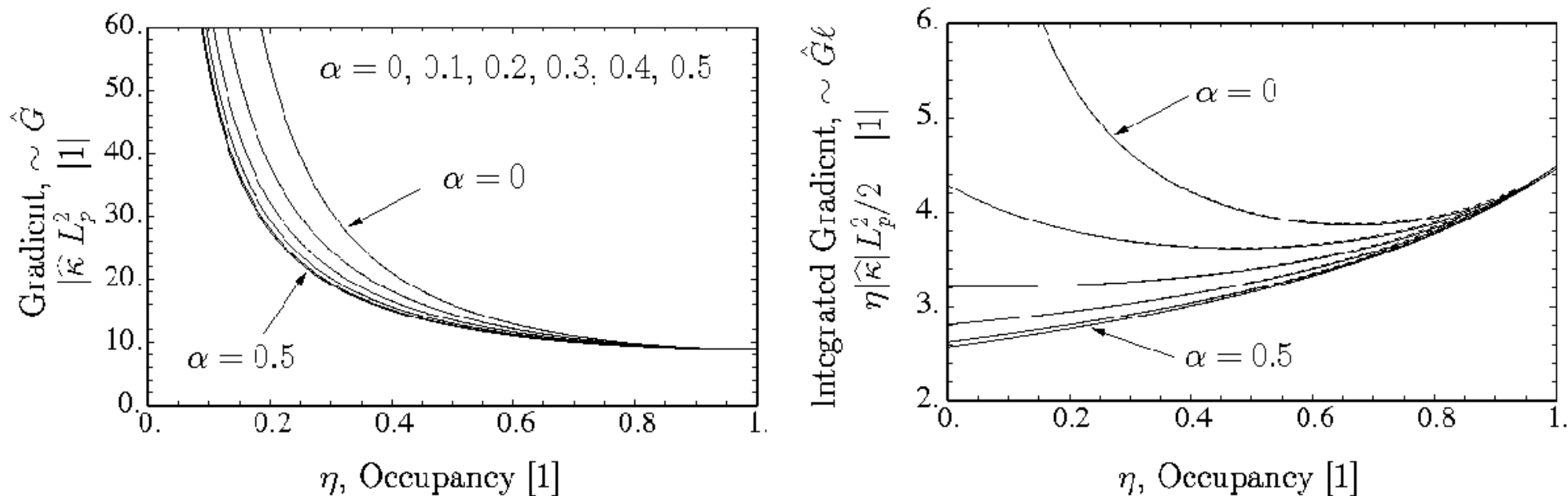

- ◆ Exact (non-expanded) solutions plotted dashed (almost overlay)
- ◆ **Gradient** and **integrated gradient** required depend only weakly on syncopation factor α when α is near or larger than $1/2$
- ◆ Stronger **gradient** required for low occupancy η but integrated gradient varies comparatively less with η except for small α

///

Appendix A: Calculation of $w(s)$ from Principal Orbit Functions

Evaluate principal orbit expressions of the transfer matrix through one lattice period using

$$w(s_i + L_p) = w_i$$

$$w'(s_i + L_p) = w'_i$$

and

$$\Delta\psi(s_i + L_p) = \int_{s_i}^{s_i + L_p} \frac{ds}{w^2(s)} = \sigma_0$$

to obtain (see principal orbit formulas expressed in phase-amplitude form):

$$C(s_i + L_p | s_i) = \cos \sigma_0 - w_i w'_i \sin \sigma_0$$

$$S(s_i + L_p | s_i) = w_i^2 \sin \sigma_0$$

$$C'(s_i + L_p | s_i) = - \left(\frac{1}{w_i^2} + w_i w'_i \right) \sin \sigma_0$$

$$S'(s_i + L_p | s_i) = \cos \sigma_0 + w_i w'_i \sin \sigma_0$$

Giving:

$$w_i = \sqrt{\frac{S(s_i + L_p | s_i)}{\sin \sigma_0}}$$

$$w'_i = \frac{\cos \sigma_0 - C(s_i + L_p | s_i)}{\sqrt{S(s_i + L_p | s_i) \sin \sigma_0}}$$

Apply $C(s|s_i)$ Eqn.

Apply $S(s|s_i)$ Eqn.
+ w_i Result Above

Or in terms of the betatron formulation (see: **S7** and **S8**) with

$$\beta = w^2, \quad \beta' = 2ww'$$

$$\beta_i = w_i^2 = \frac{S(s_i + L_p | s_i)}{\sin \sigma_0}$$

$$\beta'_i = 2w_i w'_i = \frac{2[\cos \sigma_0 - C(s_i + L_p | s_i)]}{\sin \sigma_0}$$

Next, calculate w from the principal orbit expression in phase-amplitude form:

$$\frac{S}{w_i w} = \sin \Delta\psi$$

$$S \equiv S(s|s_i) \text{ etc.}$$

$$\frac{w_i}{w} C + \frac{w'_i}{w} S = \cos \Delta\psi$$

Square and add equations:

$$\left(\frac{S}{w_i w}\right)^2 + \left(\frac{w_i C}{w} + \frac{w'_i S}{w}\right)^2 = 1$$

- ◆ This result reflects the structure of the underlying Courant-Snyder invariant (see: **S7**)

Gives:

$$w^2 = \left(\frac{S}{w_i}\right)^2 + (w_i C + w'_i S)^2$$

Use w_i , w'_i previously identified and write out result:

$$w^2(s) = \beta(s) = \sin^2 \sigma_0 \frac{S^2(s|s_i)}{S(s_i + L_p|s_i)} + \frac{S(s_i + L_p|s_i)}{\sin \sigma_0} \left[C(s|s_i) + \frac{\cos \sigma_0 - C(s_i + L_p|s_i)}{S(s_i + L_p|s_i)} S(s|s_i) \right]^2$$

- ◆ Formula shows that for a given σ_0 (used to specify lattice focusing strength), $w(s)$ is given by two linear principal orbits calculated over one lattice period
 - Easy to apply numerically

An alternative way to calculate $w(s)$ is as follows. 1st apply the phase-amplitude formulas for the principal orbit functions with:

$$s_i \rightarrow s$$

$$s \rightarrow s + L_p$$

$$\Rightarrow \begin{aligned} C(s + L_p|s) &= \cos \sigma_0 - w(s)w'(s) \sin \sigma_0 \\ S(s + L_p|s) &= w^2(s) \sin \sigma_0 \end{aligned}$$

$$w^2(s) = \beta(s) = \frac{S(s + L_p|s)}{\sin \sigma_0} = \frac{\mathbf{M}_{12}(s + L_p|s)}{\sin \sigma_0}$$

- ◆ Formula requires calculation of $S(s + L_p|s)$ at every value of s within lattice period
- ◆ Previous formula requires one calculation of $C(s|s_i)$, $S(s|s_i)$ for $s_i \leq s \leq s_i + L_p$ and any value of s_i

Matrix algebra can be applied to simplify this result:



$$\begin{aligned}
 \mathbf{M}(s + L_p|s) &= \mathbf{M}(s + L_p|s_i + L_p) \cdot \mathbf{M}(s_i + L_p|s) \\
 &= \mathbf{M}(s|s_i) \cdot \mathbf{M}(s_i + L_p|s) \cdot [\mathbf{M}(s|s_i) \cdot \mathbf{M}^{-1}(s|s_i)] \\
 &= \mathbf{M}(s|s_i) \cdot \mathbf{M}(s_i + L_p|s_i) \cdot \mathbf{M}^{-1}(s|s_i)
 \end{aligned}$$

$$\mathbf{M}(s + L_p|s) = \mathbf{M}(s|s_i) \cdot \mathbf{M}(s_i + L_p|s_i) \cdot \mathbf{M}^{-1}(s|s_i)$$

- Using this result with the previous formula allows the transfer matrix to be calculated only once per period from any initial condition

- Using:

$$\mathbf{M} = \begin{pmatrix} C & S \\ C' & S' \end{pmatrix} \quad \mathbf{M}^{-1} = \begin{pmatrix} S' & -S \\ -C' & C \end{pmatrix}$$

Apply Wronskian condition:

$$\det \mathbf{M} = 1$$

The matrix formula can be shown to be equivalent to the previous one

- Methodology applied in: Lund, Chilton, and Lee, PRSTAB **9** 064201 (2006) to construct a fail-safe iterative matched envelope including space-charge **A5**

S7: Hill's Equation: The Courant-Snyder Invariant and Single Particle Emittance

S7A: Introduction

Constants of the motion can simplify the interpretation of dynamics in physics

- ◆ Desirable to identify constants of motion for Hill's equation for improved understanding of focusing in accelerators
- ◆ Constants of the motion are not immediately obvious for Hill's Equation due to s-varying focusing forces related to $\kappa(s)$ can add and remove energy from the particle
 - Wronskian symmetry is one useful symmetry
 - Are there other symmetries?

/// Illustrative Example: Continuous Focusing/Simple Harmonic Oscillator

Equation of motion:

$$x'' + k_{\beta 0}^2 x = 0 \quad k_{\beta 0}^2 = \text{const} > 0$$

Constant of motion is the well-known Hamiltonian/Energy:

$$H = \frac{1}{2} x'^2 + \frac{1}{2} k_{\beta 0}^2 x^2 = \text{const}$$

which shows that the particle moves on an ellipse in x - x' phase-space with:

- ◆ Location of particle on ellipse set by initial conditions
- ◆ All initial conditions with same energy/ H give same ellipse

$$\text{Max/Min}[x] \Leftrightarrow x' = 0$$

$$\text{Max/Min}[x] = \pm \sqrt{2H/k_{\beta 0}^2}$$

$$\text{Max/Min}[x'] \Leftrightarrow x = 0$$

$$\text{Max/Min}[x'] = \pm \sqrt{2H}$$

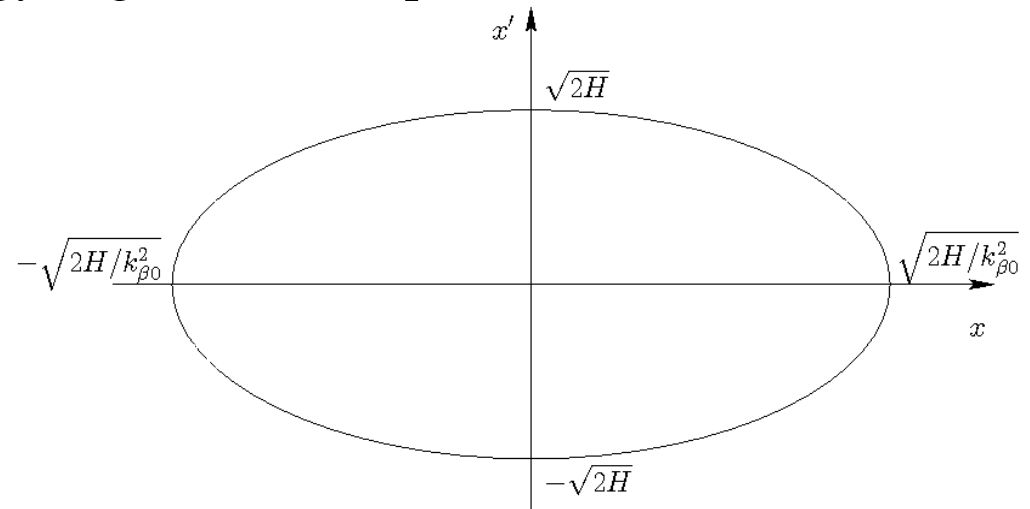

///

Question:

For Hill's equation:

$$x'' + \kappa(s)x = 0$$

does a quadratic invariant exist that can aid interpretation of the dynamics?

Answer we will find:

Yes, the Courant-Snyder invariant

Comments:

- ◆ Very important in accelerator physics
 - Helps interpretation of linear dynamics
- ◆ Named in honor of Courant and Snyder who popularized its use in Accelerator physics while co-discovering alternating gradient (AG) focusing in a single seminal (and very elegant) paper:
 - Courant and Snyder, *Theory of the Alternating Gradient Synchrotron*, Annals of Physics **3**, 1 (1958).
 - Christofolos also understood AG focusing in the same period using a more heuristic analysis
- ◆ Easily derived using phase-amplitude form of orbit solution
 - Can be much harder using other methods

S7B: Derivation of Courant-Snyder Invariant

The phase amplitude method described in S6 makes identification of the invariant elementary. Use the phase amplitude form of the orbit:

$$x(s) = A_i w(s) \cos \psi(s)$$

$$x'(s) = A_i w'(s) \cos \psi(s) - \frac{A_i}{w(s)} \sin \psi(s)$$

$A_i, \psi_i = \psi(s_i)$
set by initial
at $s = s_i$

where

$$w'' + \kappa(s)w - \frac{1}{w^3} = 0$$

Re-arrange the phase-amplitude trajectory equations:

$$\frac{x}{w} = A_i \cos \psi$$

$$wx' - w'x = A_i \sin \psi$$

square and add the equations to obtain the **Courant-Snyder invariant**:

$$\begin{aligned} \left(\frac{x}{w}\right)^2 + (wx' - w'x)^2 &= A_i^2 (\cos^2 \psi + \sin^2 \psi) \\ &= A_i^2 = \text{const} \end{aligned}$$

Comments on the Courant-Snyder Invariant:

- ◆ Simplifies interpretation of dynamics (will show how shortly)
- ◆ Extensively used in accelerator physics
- ◆ Quadratic structure in x - x' defines a **rotated ellipse** in x - x' phase space.

◆ Because
$$w^2 \left(\frac{x}{w} \right)' = wx' - w'x$$

the Courant-Snyder invariant can be alternatively expressed as:

$$\left(\frac{x}{w} \right)^2 + \left[w^2 \left(\frac{x}{w} \right)' \right]^2 = \text{const}$$

- ◆ *Cannot* be interpreted as a conserved energy!

The point that the Courant-Snyder invariant is *not* a conserved energy should be elaborated on. The equation of motion:

$$x'' + \kappa(s)x = 0$$

Is derivable from the Hamiltonian

$$H = \frac{1}{2}x'^2 + \frac{1}{2}\kappa x^2 \quad \Longrightarrow \quad \begin{aligned} \frac{d}{ds}x &= \frac{\partial H}{\partial x'} = x' \\ \frac{d}{ds}x' &= -\frac{\partial H}{\partial x} = -\kappa x \end{aligned} \quad \Longrightarrow \quad x'' + \kappa x = 0$$

H is the energy:

$$H = \frac{1}{2}x'^2 + \frac{1}{2}\kappa x^2 = T + V$$

$$T = \frac{1}{2}x'^2 = \text{Kinetic "Energy"}$$

$$V = \frac{1}{2}\kappa x^2 = \text{Potential "Energy"}$$

Apply the chain-Rule with $H = H(x, x'; s)$:

$$\frac{dH}{ds} = \frac{\partial H}{\partial s} + \frac{\partial H}{\partial x} \frac{dx}{ds} + \frac{\partial H}{\partial x'} \frac{dx'}{ds}$$

Apply the equation of motion in Hamiltonian form:

$$\frac{d}{ds}x = \frac{\partial H}{\partial x'} \quad \frac{d}{ds}x' = -\frac{\partial H}{\partial x}$$

$$\frac{dH}{ds} = \frac{\partial H}{\partial s} - \frac{dx'}{ds} \frac{dx}{ds} + \frac{dx}{ds} \frac{dx'}{ds} = \frac{\partial H}{\partial s} = \frac{1}{2}\kappa' x^2 \neq 0$$

$$\implies H \neq \text{const}$$

- ◆ Energy of a “kicked” oscillator with $\kappa(s) \neq \text{const}$ is not conserved
- ◆ Energy should not be confused with the Courant-Snyder invariant

/// Aside: Only for the special case of **continuous focusing** (i.e., a simple Harmonic oscillator) are the Courant-Snyder invariant and energy simply related:

Continuous Focusing: $\kappa(s) = k_{\beta 0}^2 = \text{const}$

$$\implies H = \frac{1}{2}x'^2 + \frac{1}{2}k_{\beta 0}^2 x^2 = \text{const}$$

w equation: $w'' + k_{\beta 0}^2 w - \frac{1}{w^3} = 0$

$$\implies w = \sqrt{\frac{1}{k_{\beta 0}}} = \text{const}$$

Courant-Snyder Invariant: $\left(\frac{x}{w}\right)^2 + (wx' - w'x)^2 = \text{const}$

$$\begin{aligned} \implies \left(\frac{x}{w}\right)^2 + (wx' - w'x)^2 &= k_{\beta 0}x^2 + \frac{x'^2}{k_{\beta 0}} \\ &= \frac{2}{k_{\beta 0}} \left(\frac{1}{2}x'^2 + \frac{1}{2}k_{\beta 0}^2 x^2 \right) \\ &= \frac{2H}{k_{\beta 0}} = \text{const} \end{aligned}$$

///

Interpret the **Courant-Snyder invariant**:

$$\left(\frac{x}{w}\right)^2 + (wx' - w'x)^2 = A_i^2 = \text{const}$$

by expanding and isolating terms quadratic terms in x - x' phase-space variables:

$$\left[\frac{1}{w^2} + w'^2\right] x^2 + 2[-ww']xx' + [w^2]x'^2 = A_i^2 = \text{const}$$

The three coefficients in [...] are functions of w and w' only and therefore are *functions of the lattice only* (not particle initial conditions). They are commonly called “**Twiss Parameters**” and are expressed denoted as:

$$\gamma x^2 + 2\alpha xx' + \beta x'^2 = A_i^2 = \text{const}$$

$$\gamma(s) \equiv \frac{1}{w^2(s)} + [w'(s)]^2 = \frac{1 + \alpha^2(s)}{\beta(s)}$$

$$\beta(s) \equiv w^2(s)$$

$$\alpha(s) \equiv -w(s)w'(s)$$

$$\gamma\beta = 1 + \alpha^2$$

- ◆ All Twiss “parameters” are specified by $w(s)$
- ◆ Given w and w' at a point (s) any 2 Twiss parameters give the 3rd

The area of the invariant ellipse is:

- ◆ Analytic geometry formulas: $\gamma x^2 + 2\alpha x x' + \beta x'^2 = \pi A_i^2 \rightarrow Area = A_i^2 / \sqrt{\gamma\beta - \alpha^2}$
- ◆ For Courant-Snyder ellipse: $\gamma\beta = 1 + \alpha^2$

$$\text{Phase-Space Area} = \int_{\text{ellipse}} dx dx' = \frac{\pi A_i^2}{\sqrt{\gamma\beta - \alpha^2}} = \pi A_i^2 \equiv \pi\epsilon$$

Where ϵ is the **single-particle emittance**:

- ◆ Emittance is the area of the orbit in x - x' phase-space divided by π

$$[1/w^2 + w'^2]x^2 + 2[-ww']xx' + [w^2]x'^2 = \epsilon$$

$$\gamma x^2 + 2\alpha x x' + \beta x'^2 = \epsilon = \text{const}$$

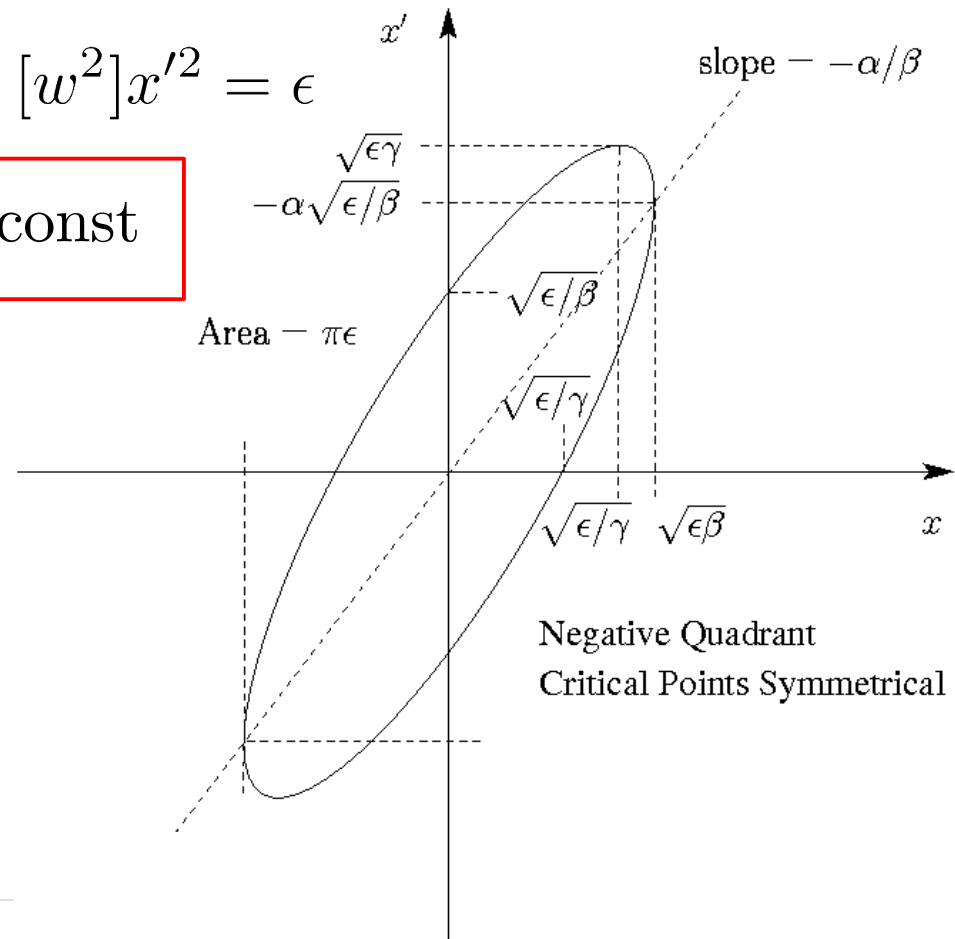

See problem sets
for critical point
calculation

/// Aside on Notation: [Twiss Parameters](#) and [Emittance Units](#):

[Twiss Parameters](#):

Use of α , β , γ should not create confusion with kinematic relativistic factors

- ◆ β_b , γ_b are absorbed in the focusing function
- ◆ Contextual use of notation unfortunate reality not enough symbols!
- ◆ Notation originally due to Courant and Snyder, not Twiss, and might be more appropriately called “Courant-Snyder functions” or “lattice functions.”

[Emittance Units](#):

x has dimensions of length and x' is a dimensionless angle. So x - x' phase-space area has dimensions $[[\epsilon]] = \text{length}$. A common choice of units is millimeters (mm) and milliradians (mrad), e.g.,

$$\epsilon = 10 \text{ mm-mrad}$$

The definition of the emittance employed is not unique and different workers use a wide variety of symbols. Some common notational choices:

$$\pi\epsilon \rightarrow \epsilon \quad \epsilon \rightarrow \varepsilon \quad \epsilon \rightarrow E$$

Write the emittance values in units with a π , e.g.,

$$\epsilon = 10.5 \pi \text{ mm-mrad} \quad (\text{seems falling out of favor but still common})$$

Use caution! Understand conventions being used before applying results!

///

Emittance is sometimes defined by the largest Courant-Snyder ellipse that will contain a specified fraction of the distribution of beam particles.

Common choices are:

- ◆ 100%
- ◆ 95%
- ◆ 90%
- ◆
- ◆ Depends emphasis

Figure to be added

(use pic of distorted intensity map in x-x' with nested ellipses superimposed at different distribution fractions.

We will motivate (problems and later lectures) that the statistical measure

$$\begin{aligned} \varepsilon_{\text{rms}} &= \left[\langle \langle x^2 \rangle \langle x'^2 \rangle - \langle x x' \rangle^2 \right]^{1/2} & \langle \dots \rangle &= \text{Distribution Average} \\ &= \text{rms Statistical Emittance} \end{aligned}$$

provides a distribution weighted average measure of the beam phase-space area.

Properties of Courant-Snyder Invariant:

- ◆ The ellipse will **rotate** and **change shape** as the particle advances through the focusing lattice, but the instantaneous **area** of the ellipse ($\pi\epsilon = \text{const}$) **remains constant**.
- ◆ The **location** of the particle on the ellipse and the **size** (area) of the ellipse depends on the initial conditions of the particle.
- ◆ The **orientation** of the ellipse is **independent of the particle initial conditions**.
All particles move on nested ellipses.
- ◆ **Quadratic** in the x - x' phase-space coordinates, but is **not the transverse particle energy** (which is not conserved).

S7C: Lattice Maps

The **Courant-Snyder invariant** helps us understand the phase-space evolution of the particles. Knowing how the ellipse transforms (twists and rotates without changing area) is equivalent to knowing the dynamics of a *bundle* of particles.

To see this:

General s :

$$\gamma x^2 + 2\alpha x x' + \beta x'^2 = \epsilon$$

Initial $s = s_i$

$$\gamma_i x_i^2 + 2\alpha_i x_i x'_i + \beta_i x_i'^2 = \epsilon$$

$$\beta_i \equiv \beta(s = s_i) \quad x_i \equiv x(s = s_i)$$

$$\alpha_i \equiv \alpha(s = s_i) \quad x'_i \equiv x'(s = s_i)$$

$$\gamma_i \equiv \gamma(s = s_i)$$

Apply the components of the transport matrix:

$$\begin{bmatrix} x \\ x' \end{bmatrix} = \mathbf{M}(s|s_i) \cdot \begin{bmatrix} x_i \\ x'_i \end{bmatrix} = \begin{bmatrix} C(s|s_i) & S(s|s_i) \\ C'(s|s_i) & S'(s|s_i) \end{bmatrix} \cdot \begin{bmatrix} x_i \\ x'_i \end{bmatrix}$$

Invert 2x2 matrix and apply $\det \mathbf{M} = 1$ (Wronskian):

$$\implies \begin{bmatrix} x_i \\ x'_i \end{bmatrix} = \begin{bmatrix} S' & -S \\ -C' & C \end{bmatrix} \cdot \begin{bmatrix} x \\ x' \end{bmatrix} \quad C \equiv C(s|s_i), \text{ etc.}$$

Insert expressions for x_i , x'_i in the initial ellipse expression, collect factors of x^2 , xx' , x'^2 and equate to general s ellipse expression:

$$\begin{aligned}
 & [\gamma_i S'^2 - 2\alpha_i S' C' + \beta_i C'^2] x^2 \\
 & + 2[-\gamma_i S S' + \alpha_i (C S' + S C') - \beta_i C C'] x x' \\
 & + [\gamma_i S^2 - 2\alpha_i S C + \beta_i C^2] x'^2 \\
 & \hspace{20em} = \gamma x^2 + 2\alpha x x' + \beta x'^2
 \end{aligned}$$

Collect coefficients of x^2 , xx' , and x'^2 and summarize in matrix form:

$$\begin{bmatrix} \gamma \\ \alpha \\ \beta \end{bmatrix} = \begin{bmatrix} S'^2 & -2C'S' & C'^2 \\ -SS' & CS' + SC' & -CC' \\ S^2 & -2CS & C^2 \end{bmatrix} \cdot \begin{bmatrix} \gamma_i \\ \alpha_i \\ \beta_i \end{bmatrix}$$

This result can be applied to illustrate how a bundle of particles will evolve from an initial location in the lattice subject to the linear focusing optics in the machine using only principal orbits C , S , C' , and S'

- ◆ Principal orbits will generally need to be calculated numerically
 - Intuition can be built up using simple analytical results (hard edge etc)
- ◆ Can express C , S , C' , S' in terms of CS-ellipse functions using [S6F](#) results and definitions for β , α

/// Example: Ellipse Evolution in a simple kicked focusing lattice

Drift:
$$\begin{bmatrix} C & S \\ C' & S' \end{bmatrix} = \begin{bmatrix} 1 & s - s_i \\ 0 & 1 \end{bmatrix}$$

$$\gamma = \gamma_i$$

$$\alpha = -\gamma_i(s - s_i) + \alpha_i$$

$$\beta = \gamma_i(s - s_i)^2 - 2\alpha_i(s - s_i) + \beta_i$$

Thin Lens:
focal length f
$$\begin{bmatrix} C & S \\ C' & S' \end{bmatrix} = \begin{bmatrix} 1 & 0 \\ -1/f & 1 \end{bmatrix}$$

$$\gamma = \gamma_i + 2\alpha_i/f + \beta_i/f^2$$

$$\alpha = -\beta_i/f + \alpha_i$$

$$\beta = \beta_i$$

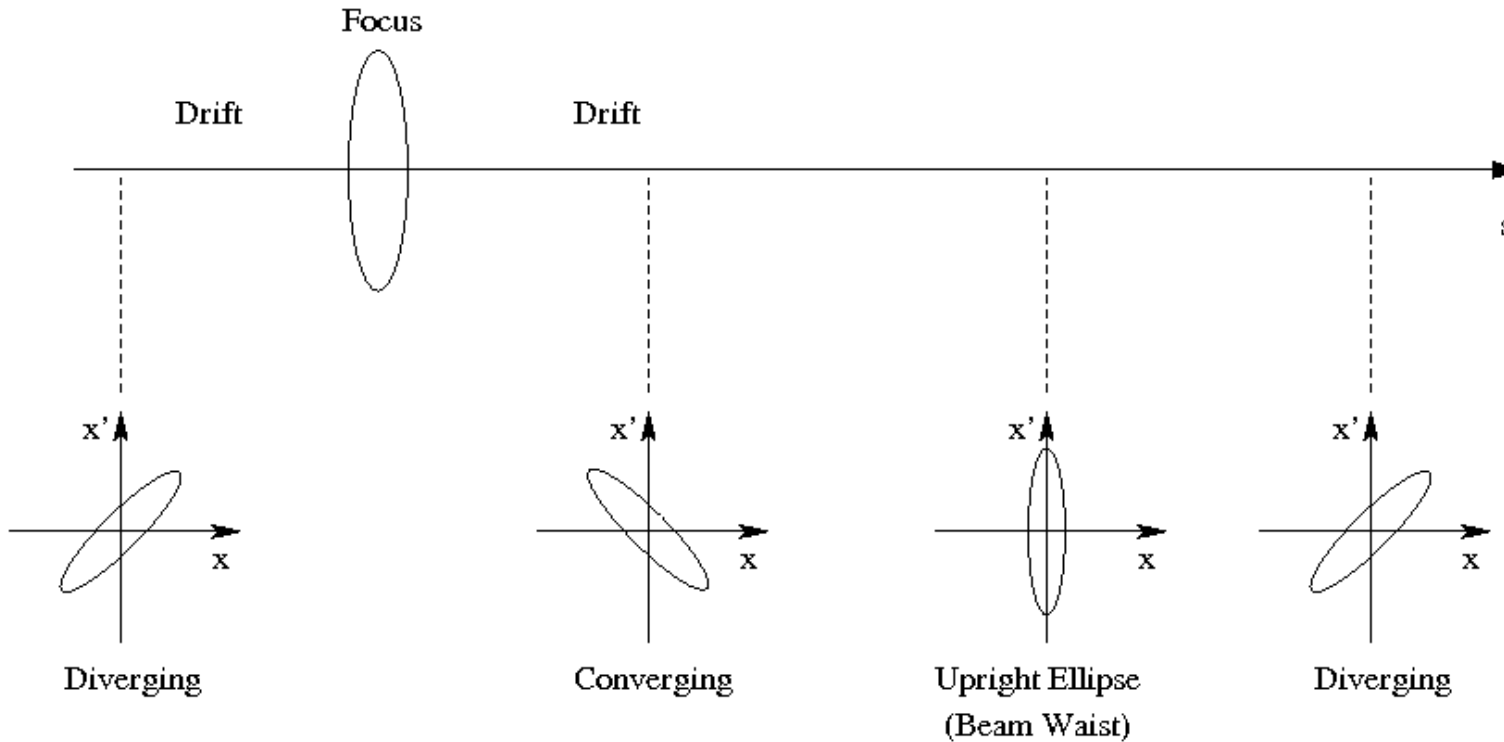

For further examples of phase-space ellipse evolutions in standard lattices, see previous examples given in: **S6G**

///

Rather than use a 3x3 advance matrix for γ , α , β , we can alternatively derive an expression based on the usual 2x2 transfer matrix \mathbf{M} which will help further clarify the underlying structure of the linear dynamics.

Recall in [S6F](#)

$$\begin{bmatrix} x(s) \\ x'(s) \end{bmatrix} = \mathbf{M}(s|s_i) \cdot \begin{bmatrix} x(s_i) \\ x'(s_i) \end{bmatrix} = \begin{bmatrix} C(s|s_i) & S(s|s_i) \\ C'(s|s_i) & S'(s|s_i) \end{bmatrix} \cdot \begin{bmatrix} x(s_i) \\ x'(s_i) \end{bmatrix}$$

$$C(s|s_i) = \frac{w(s)}{w_i} \cos \Delta\psi(s) - w'_i w(s) \sin \Delta\psi(s)$$

$$S(s|s_i) = w_i w(s) \sin \Delta\psi(s)$$

$$C'(s|s_i) = \left(\frac{w'(s)}{w_i} - \frac{w'_i}{w(s)} \right) \cos \Delta\psi(s) - \left(\frac{1}{w_i w(s)} + w'_i w'(s) \right) \sin \Delta\psi(s)$$

$$S'(s|s_i) = \frac{w_i}{w(s)} \cos \Delta\psi(s) + w_i w'(s) \sin \Delta\psi(s)$$

$$\Delta\psi(s) \equiv \int_{s_i}^s \frac{d\tilde{s}}{w^2(\tilde{s})} \qquad \begin{aligned} w_i &\equiv w(s = s_i) \\ w'_i &\equiv w'(s = s_i) \end{aligned}$$

Using this and

$$\beta \equiv w^2$$

$$\alpha \equiv -ww'$$

\implies

$$\frac{w}{w_i} = \sqrt{\frac{\beta}{\beta_i}}$$

$$-w'_i w = (-w'_i w_i) \frac{w}{w_i} = \alpha_i \sqrt{\frac{\beta}{\beta_i}}$$

... etc.

After some algebra, we obtain the expression

$$\mathbf{M}(s|s_i) = \begin{bmatrix} C(s|s_i) & S(s|s_i) \\ C'(s|s_i) & S'(s|s_i) \end{bmatrix}$$

$$= \begin{bmatrix} \sqrt{\frac{\beta(s)}{\beta_i}} [\cos \Delta\psi(s) + \alpha_i \sin \Delta\psi(s)] & \sqrt{\beta_i \beta} \sin \Delta\psi(s) \\ -\frac{\alpha(s) - \alpha_i}{\sqrt{\beta_i \beta(s)}} \cos \Delta\psi(s) - \frac{1 + \alpha_i \alpha(s)}{\sqrt{\beta_i \beta(s)}} \sin \Delta\psi(s) & \sqrt{\frac{\beta_i}{\beta(s)}} [\cos \Delta\psi(s) - \alpha \sin \Delta\psi(s)] \end{bmatrix}$$

- ◆ Transfer matrix now expressed in terms of Courant-Snyder ellipse functions, their initial values, and the phase advance from the initial point.

For the special case of a periodic lattice with an advance over one period

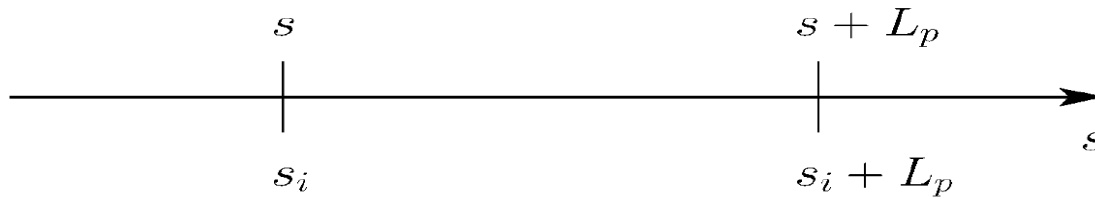

$$\alpha(s_i) = \alpha(s) \quad \beta(s_i) = \beta(s) \quad \gamma(s_i) = \gamma(s) \quad \Delta\psi = \sigma_0$$

this expression for \mathbf{M} reduces to

$$\begin{aligned} \mathbf{M}(s_i + L_p | s_i) &= \begin{bmatrix} \cos \sigma_0 + \alpha \sin \sigma_0 & \beta \sin \sigma_0 \\ -\gamma \sin \sigma_0 & \cos \sigma_0 - \alpha \sin \sigma_0 \end{bmatrix} \\ &= \mathbf{I} \cos \sigma_0 + \mathbf{J}(s) \sin \sigma_0 \end{aligned}$$

$$\mathbf{I} \equiv \begin{bmatrix} 1 & 0 \\ 0 & 1 \end{bmatrix} \quad \mathbf{J} \equiv \begin{bmatrix} \alpha(s) & \beta(s) \\ -\gamma(s) & -\alpha(s) \end{bmatrix} \quad 1 + \alpha^2 = \gamma\beta$$

$$\sigma_0 \equiv \int_{s_i}^{s_i + L_p} \frac{d\tilde{s}}{\beta(\tilde{s})}$$

It is straightforward to verify that:

$$\det \mathbf{J} = -\alpha^2 + \gamma\beta = 1 \quad e^{\mathbf{J}\psi(s)} = \mathbf{I} \cos \psi(s) + \mathbf{J} \sin \psi(s)$$

$$\mathbf{J} \cdot \mathbf{J} = -\mathbf{I}$$

An advance $s_i \rightarrow s + L_p$ through any interval in a periodic lattice can be resolved as:



Giving for $\mathbf{M}(s + L_p | s_i)$:

$$\begin{aligned} \mathbf{M}(s + L_p | s) \cdot \mathbf{M}(s | s_i) &= \mathbf{M}(s + L_p | s_i + L_p) \cdot \mathbf{M}(s_i + L_p | s_i) \\ \text{Or:} \qquad \qquad \qquad &= \mathbf{M}(s | s_i) \cdot \mathbf{M}(s_i + L_p | s_i) \end{aligned}$$

$$\mathbf{M}(s + L_p | s) = \mathbf{M}(s | s_i) \cdot \mathbf{M}(s_i + L_p | s_i) \cdot \mathbf{M}^{-1}(s | s_i)$$

Using:

$$\mathbf{M}(s + L_p | s) = \mathbf{I} \cos \sigma_0 + \mathbf{J}(s) \sin \sigma_0$$

$$\mathbf{M}(s_i + L_p | s_i) = \mathbf{I} \cos \sigma_0 + \mathbf{J}(s_i) \sin \sigma_0$$

$$\implies \boxed{\mathbf{J}(s) = \mathbf{M}(s | s_i) \cdot \mathbf{J}(s_i) \cdot \mathbf{M}^{-1}(s | s_i)} \quad \mathbf{J} \equiv \begin{bmatrix} \alpha & \beta \\ -\gamma & -\alpha \end{bmatrix}$$

- Simple formula connects the Courant Synder functions γ, α, β at an initial point $s = s_i$ to any location s in the lattice in terms of the transfer matrix \mathbf{M} .
- Result does *NOT* require the lattice to be periodic. Periodic extensions can be used to generalize arguments employed to work for *any* lattice interval.

S8: Hill's Equation: The Betatron Formulation of the Particle Orbit and Maximum Orbit Excursions S8A: Formulation

The **phase-amplitude** form of the particle orbit analyzed in **S6** of

$$x(s) = A_i w(s) \cos \psi(s) = \sqrt{\epsilon} w(s) \cos \psi(s) \quad [[w]] = (\text{meters})^{1/2}$$

is not a unique choice. Here, w has dimensions $\sqrt{\text{meters}}$, which can render it inconvenient in applications. Due to this and the utility of the Twiss parameters used in describing orientation of the phase-space ellipse associated with the Courant-Snyder invariant (see: **S7**) on which the particle moves, it is convenient to define an alternative, **Betatron** representation of the orbit with:

$$x(s) = \sqrt{\epsilon} \sqrt{\beta(s)} \cos \psi(s)$$

Betatron function: $\beta(s) \equiv w^2(s)$

Single-Particle Emittance: $\epsilon \equiv A_i^2 = \text{const}$

Phase: $\psi(s) = \psi_i + \int_{s_i}^s \frac{d\tilde{s}}{\beta(\tilde{s})} = \psi_i + \Delta\psi(s)$

- ◆ The betatron function is a Twiss “parameter” with dimension $[[\beta]] = \text{meters}$

Comments:

- ◆ Use of the symbol β for the betatron function does not result in confusion with relativistic factors such as β_b since the context of use will make clear
 - Relativistic factors often absorbed in lattice focusing function and do not directly appear in the dynamical descriptions
- ◆ The change in phase $\Delta\psi$ is the same for both formulations:

$$\Delta\psi(s) = \int_{s_i}^s \frac{d\tilde{s}}{w^2(\tilde{s})} = \int_{s_i}^s \frac{d\tilde{s}}{\beta(\tilde{s})}$$

From the equation for w :

$$w''(s) + \kappa(s)w(s) - \frac{1}{w^3(s)} = 0$$

$$w(s + L_p) = w(s) \quad w(s) > 0$$

the betatron function is described by:

$$w = \beta^{1/2}$$

$$w' = \frac{1}{2} \frac{\beta'}{\beta^{1/2}}$$

$$w'' = \frac{1}{2} \frac{\beta''}{2\beta^{1/2}} - \frac{1}{4} \frac{\beta'^2}{\beta^{3/2}}$$

$$\implies \frac{1}{2} \beta(s) \beta''(s) - \frac{1}{4} \beta'^2(s) + \kappa(s) \beta^2(s) = 1$$

$$\beta(s + L_p) = \beta(s) \quad \beta(s) > 0$$

- The betatron function represents, analogously to the w -function, a special function defined by the periodic lattice. Similar to $w(s)$ it is a unique function of the lattice.
- The equation is still nonlinear but we can apply our previous analysis of $w(s)$ (see **S6 Appendix A**) to solve analytically in terms of the principle orbits

S8B: Maximum Orbit Excursions

From the orbit equation

$$x = \sqrt{\epsilon\beta} \cos \psi$$

the **maximum** and **minimum** possible **particle excursions** occur where:

$$\cos \psi = +1 \quad \longrightarrow \quad \text{Max}[x] = \sqrt{\epsilon\beta(s)} = \sqrt{\epsilon}w(s)$$

$$\cos \psi = -1 \quad \longrightarrow \quad \text{Min}[x] = -\sqrt{\epsilon\beta(s)} = -\sqrt{\epsilon}w(s)$$

Thus, the max radial extent of *all* particle oscillations $\text{Max}[x] \equiv x_m$ in the beam distribution occurs for the particle with the max single particle emittance since the particles move on nested ellipses:

In terms of Twiss parameters:

$$\text{Max}[\epsilon] \equiv \epsilon_m$$

$$x_m(s) = \sqrt{\epsilon_m\beta(s)} = \sqrt{\epsilon_m}w(s)$$

$$x_m = \sqrt{\epsilon_m}w = \sqrt{\epsilon_m\beta}$$

$$x'_m = \sqrt{\epsilon_m}w' = -\sqrt{\frac{\epsilon_m}{\beta}}\alpha$$

- ◆ Assumes sufficient numbers of particles to populate all possible phases
- ◆ x_m corresponds to the min possible machine aperture to prevent particle losses
 - Practical aperture choice influenced by: resonance effects due to nonlinear applied fields, space-charge, scattering, finite particle lifetime,

From:

$$w''(s) + \kappa(s)w(s) - \frac{1}{w^3(s)} = 0$$

$$w(s + L_p) = w(s) \quad w(s) > 0$$

We immediately obtain an equation for the maximum locus (envelope) of radial particle excursions $x_m = \sqrt{\epsilon_m}w$ as:

$$x_m''(s) + \kappa(s)x_m(s) - \frac{\epsilon_m^2}{x_m^3(s)} = 0$$

$$x_m(s + L_p) = x_m(s) \quad x_m(s) > 0$$

Comments:

- ◆ Equation is **analogous to the statistical envelope equation** derived by J.J. Barnard in the **Intro Lectures** when a space-charge term is added and the max single particle emittance is interpreted as a statistical emittance
 - correspondence will become more concrete in later lectures
- ◆ This correspondence will be developed more extensively in later lectures on **Transverse Centroid and Envelope Descriptions of Beam Evolution** and **Transverse Equilibrium Distributions**

S9: Momentum Spread Effects in Bending and Focusing

S9A: Formulation

Except for brief digressions in **S1** and **S4**, we have concentrated on particle dynamics where all particles have the design longitudinal momentum at a value of s in the lattice:

$$p_s = m\gamma_b\beta_b c = \text{same for every particle}$$

Realistically, there will always be a finite spread of particle momentum within a beam slice, so we take:

$$p_s = p_0 + \delta p$$

$$p_0 \equiv m\gamma_b\beta_b c = \text{Design Momentum}$$

$$\delta p \equiv \text{Off Momentum}$$

Typical values of momentum spread in a beam with a single species of particles with conventional sources and accelerating structures:

$$\frac{|\delta p|}{p_0} \sim 10^{-2} \rightarrow 10^{-6}$$

The spread of particle momentum can modify particle orbits, particularly when dipole bends are present since the bend radius depends strongly on the particle momentum

To better understand this effect, we analyze the particle equations of motion with leading-order momentum spread (see: **S1H**) effects retained:

$$x''(s) + \left[\frac{1}{R^2(s)} \frac{1 - \delta}{1 + \delta} + \frac{\kappa_x(s)}{(1 + \delta)^n} \right] x(s) = \frac{\delta}{1 + \delta} \frac{1}{R(s)}$$

$$y''(s) + \frac{\kappa_y(s)}{(1 + \delta)^n} y(s) = 0$$

Magnetic Dipole Bend

$R(s)$ = Local Bend Radius
for design momentum p_0
($R \rightarrow \infty$ in straight sections)

$$\frac{1}{R(s)} = \frac{B_y^a|_{\text{dipole}}}{[B\rho]}$$

$\delta \equiv \frac{\delta p}{p_0}$ $\kappa_{x,y}$ = Focusing Functions
(using design momentum)

$$[B\rho] = \frac{p_0}{q}$$

$n = \begin{cases} 1, & \text{Magnetic Quadrupoles} \\ 2, & \text{Solenoids, Electric Quadrupoles} \end{cases}$

Neglects:

- ◆ **Space-charge:** $\phi \rightarrow 0$
- ◆ **Nonlinear applied focusing:** $\mathbf{E}^a, \mathbf{B}^a$ contain only linear focus terms
- ◆ **Acceleration:** $p_0 = mc\gamma_b\beta_b = \text{const}$

In the equations of motion, it is important to understand that B_y^a of the **magnetic bends** are set from the radius R required by the design particle orbit

(see: **S1** for details)

- ◆ Equation relating R to fields must be modified for electric bends (see **S1**)
- ◆ y -plane bends also require modification of eqns (analogous to x -plane case)

The **focusing strengths** are defined with respect to the **design momentum**:

$$\kappa_x = \begin{cases} \frac{qG}{m\gamma_b\beta_b^2c^2}, & G = -\partial E_x^a/\partial x = \partial E_y^a/\partial y = \text{Electric Quad. Grad.} \\ \frac{qG}{m\gamma_b\beta_b c}, & G = \partial B_x^a/\partial y = \partial B_y^a/\partial x = \text{Magnetic Quad. Grad.} \\ \frac{qB_{z0}}{4m\gamma_b^2\beta_b^2c^2}, & B_{z0} = \text{Solenoidal Magnetic Field} \end{cases}$$

γ_b, β_b calculated from p_0

Terms in the equations of motion associated with momentum spread (δ) can be lumped into two classes:

S.9B: Dispersive -- Associated with Dipole Bends

S.9C: Chromatic -- Associated with Applied Focusing (κ)

S9B: Dispersive Effects

Present only in the x -equation of motion and **result from bending**. Neglecting chromatic terms:

$$x''(s) + \underbrace{\left[\frac{1}{R^2(s)} \frac{1-\delta}{1+\delta} + \kappa_x(s) \right]}_{\text{Term 1}} x(s) = \underbrace{\frac{\delta}{1+\delta} \frac{1}{R(s)}}_{\text{Term 2}}$$

Particles are bent at different radii when the momentum deviates from the design value ($\delta \neq 0$) leading to changes in the particle orbit

♦ Dispersive terms contain the bend radius R

Generally, the bend radii R are large and δ is small, and we can take to leading order:

$$\text{Term 1: } \left[\frac{1}{R^2} \frac{1-\delta}{1+\delta} + \kappa_x \right] x \simeq \kappa_x x$$

Careful if R not large as might be the case in low-energy beam lines

$$\text{Term 2: } \frac{\delta}{1+\delta} \frac{1}{R} \simeq \frac{\delta}{R} + \Theta(\delta^2)$$

The equations of motion then become:

$$x''(s) + \kappa_x(s)x(s) = \frac{\delta}{R(s)}$$
$$y''(s) + \kappa_y(s)y(s) = 0$$

♦ The *y*-equation is not changed from the usual Hill's Equation

The *x*-equation is typically solved for *periodic* ring lattices by exploiting the linear structure of the equation and linearly resolving:

$$x(s) = x_h(s) + x_p(s)$$

$x_h \equiv$ Homogeneous Solution

$x_p \equiv$ Particular Solution

where x_h is the *general* solution to the Hill's Equation:

$$x_h''(s) + \kappa_x(s)x_h(s) = 0$$

and x_p is the *periodic* solution to:

$$x_p = \delta \cdot D \qquad D''(s) + \kappa_x(s)D(s) = \frac{1}{R(s)}$$
$$D \equiv \text{Dispersion Function} \qquad D(s + L_p) = D(s)$$

This convenient resolution of the orbit $x(s)$ can *always* be made because the homogeneous solution will be adjusted to match any initial condition

Note that x_p provides a measure of the offset of the particle orbit relative to the design orbit resulting from a small deviation of momentum (δ)

$x(s) = 0$ defines the design orbit

$[[D]] = \text{meters}$

$\delta \cdot D = \text{Dispersion induced orbit offset in meters}$

Comments:

- ◆ It can be shown (see **Appendix B**) that D is unique given a focusing function κ_x for a periodic lattice provided that $\frac{\sigma_{0x}}{2\pi} \neq \text{integer}$
 - In this context D is interpreted as a Lattice Function similarly to the betatron function
 - Consequently, δD gives the closed orbit of an off-momentum particle in a ring due to dispersive effects
- ◆ The case of how to interpret and solve for D in a non-periodic lattice (transfer line) will be covered
 - In this case initial conditions of D will matter

Extended 3x3 Transfer Matrix Form for Dispersion Function

Can solve D in

$$D'' + \kappa_x D = \frac{1}{R}$$

by taking

$$D = D_h + D_p$$

D_h = Homogeneous Solution

D_p = Particular Solution

Homogeneous solution is the general solution to

- Usual Hill's equation with solution expressed in terms of principle functions in 2x2 matrix form

$$D_h'' + \kappa_x D_h = 0$$

$$\begin{aligned} \begin{bmatrix} D_h \\ D_h' \end{bmatrix}_s &= \mathbf{M}(s|s_i) \cdot \begin{bmatrix} D_h \\ D_h' \end{bmatrix}_{s_i} \\ &= \begin{bmatrix} C(s|s_i) & S(s|s_i) \\ C'(s|s_i) & S'(s|s_i) \end{bmatrix} \cdot \begin{bmatrix} D_h \\ D_h' \end{bmatrix}_{s_i} \end{aligned}$$

Particular solution take to be the zero initial condition solution to

- ♦ Homogeneous part used to adjust for general initial conditions: always integrate from zero initial value and angle

$$D_p'' + \kappa_x D_p = \frac{1}{R}$$

$$D_p(s_i) = 0 = D_p'(s_i)$$

Denote solution as from zero initial value and angle at $s = s_i$ as $D_p(s) = D_p(s|s_i)$

Can superimpose the homogeneous and particular solutions to form a generalized **3x3 transfer matrix** for the Dispersion function D as:

- ♦ Initial condition absorbed on homogeneous solution

$$\begin{aligned} \begin{bmatrix} D \\ D' \\ 1 \end{bmatrix}_s &= \begin{bmatrix} C(s|s_i) & S(s|s_i) & D_p(s|s_i) \\ C'(s|s_i) & S'(s|s_i) & D_p'(s|s_i) \\ 0 & 0 & 1 \end{bmatrix} \cdot \begin{bmatrix} D \\ D' \\ 1 \end{bmatrix}_{s_i} \\ &= \begin{bmatrix} [\mathbf{M}(s|s_i)] & D_p(s|s_i) \\ & D_p'(s|s_i) \\ 0 & 0 & 1 \end{bmatrix} \cdot \begin{bmatrix} D \\ D' \\ 1 \end{bmatrix}_{s_i} \equiv \mathbf{M}_3(s|s_i) \cdot \begin{bmatrix} D \\ D' \\ 1 \end{bmatrix}_{s_i} \end{aligned}$$

For a periodic solution:

$$D(s_i + L_p) = D(s_i)$$
$$D'(s_i + L_p) = D'(s_i)$$

This gives two constraints to determine the needed initial condition for periodicity

◆ Third row trivial

$$D(s_i) - C(s_i + L_p|s_i)D(s_i) - S(s_i + L_p|s_i)D'(s_i) = D_p(s_i + L_p|s_i)$$
$$D'(s_i) - C'(s_i + L_p|s_i)D(s_i) - S'(s_i + L_p|s_i)D'(s_i) = D'_p(s_i + L_p|s_i)$$

Solving this using matrix methods (inverse by minor) and simplifying the result with the Wronskian invariant (**S5C**)

$$W = C(s|s_i)S'(s|s_i) - S(s|s_i)C'(s|s_i) = 1$$

and the definition of phase advance in the periodic lattice (**S6G**)

$$\cos \sigma_{0x} = \frac{1}{2} \text{Tr } \mathbf{M}(s_i + L_p|s_i) = \frac{1}{2} [C(s_i + L_p|s_i) + S'(s_i + L_p|s_i)]$$

Yields:

$$\begin{bmatrix} D \\ D' \end{bmatrix}_{s_i} = \frac{1}{2(1 - \cos \sigma_{0x})} \begin{bmatrix} 1 - S'(s_i + L_p | s_i) & S(s_i + L_p | s_i) \\ C'(s_i + L_p | s_i) & 1 - C(s_i + L_p | s_i) \end{bmatrix} \cdot \begin{bmatrix} D_p(s_i + L_p | s_i) \\ D'_p(s_i + L_p | s_i) \end{bmatrix}$$

- ◆ Resulting solution for D from this initial condition will have the periodicity of the lattice. These values always exist for real σ_{0x} ($\sigma_{0x} < 180^\circ$)
- ◆ Values of $D(s_i)$, $D'(s_i)$ depend on location of choice of s_i in lattice period
- ◆ Can use 3x3 transfer matrix to find D anywhere in the lattice
- ◆ Formulation assumes that the underlying lattice is stable with $\sigma_{0x} < 180^\circ$

Alternatively, take $s_i = s$ to show that

$$D(s) = \frac{[1 - S'(s + L_p | s)] D_p(s + L_p | s) + S(s + L_p | s) D'_p(s + L_p | s)}{2(1 - \cos \sigma_{0x})}$$

$$D'(s) = \frac{C'(s + L_p | s) D_p(s + L_p | s) + [1 - C(s + L_p | s)] D'_p(s + L_p | s)}{2(1 - \cos \sigma_{0x})}$$

Particular Solution for the Dispersion Function in a Periodic Lattice

To solve the particular function of the dispersion from a zero initial condition,

$$D_p'' + \kappa_x D_p = \frac{1}{R} \quad D_p(s_i) = 0 = D_p'(s_i)$$

A Green's function method can be applied (see [Appendix A](#)) to express the solution in terms of projection on the principal orbits of Hill's equation as:

$$D_p(s) = \int_{s_i}^s d\tilde{s} \frac{1}{R(\tilde{s})} G(s, \tilde{s})$$

$$G(s, \tilde{s}) = \mathcal{S}(s|s_i)\mathcal{C}(\tilde{s}|s_i) - \mathcal{C}(s|s_i)\mathcal{S}(\tilde{s}|s_i)$$

$$\mathcal{C}(s|s_i) = \text{Cosine-like Principal Trajectory}$$

$$\mathcal{S}(s|s_i) = \text{Sine-like Principal Trajectory}$$

Cosine-Like Solution

$$\mathcal{C}''(s|s_i) + \kappa(s)\mathcal{C}(s|s_i) = 0$$

$$\mathcal{C}(s_i|s_i) = 1$$

$$\mathcal{C}'(s_i|s_i) = 0$$

Sine-Like Solution

$$\mathcal{S}''(s|s_i) + \kappa(s)\mathcal{S}(s|s_i) = 0$$

$$\mathcal{S}(s_i|s_i) = 0$$

$$\mathcal{S}'(s_i|s_i) = 1$$

Discussion:

- The Green's function solution for D_p , together with the 3x3 transfer matrix can be used to solve explicitly for D from an initial value
- The initial values $D(s_i)$, $D'(s_i)$ found will yield the *unique* solution for D with the periodicity of the lattice

The periodic lattice solution for the dispersion function can be expressed in terms of the betatron function of the periodic lattice as follows:

From **S7C**:

$$\mathbf{M}(s|s_i) = \begin{bmatrix} C(s|s_i) & S(s|s_i) \\ C'(s|s_i) & S'(s|s_i) \end{bmatrix}$$
$$= \begin{bmatrix} \sqrt{\frac{\beta(s)}{\beta_i}} [\cos \Delta\psi(s) + \alpha_i \sin \Delta\psi(s)] & \sqrt{\beta_i\beta} \sin \Delta\psi(s) \\ -\frac{\alpha(s) - \alpha_i}{\sqrt{\beta_i\beta(s)}} \cos \Delta\psi(s) - \frac{1 + \alpha_i\alpha(s)}{\sqrt{\beta_i\beta(s)}} \sin \Delta\psi(s) & \sqrt{\frac{\beta_i}{\beta(s)}} [\cos \Delta\psi(s) - \alpha \sin \Delta\psi(s)] \end{bmatrix}$$

and using

$$D_p(s) = \int_{s_i}^s d\tilde{s} \frac{1}{R(\tilde{s})} G(s, \tilde{s}) \quad G(s, \tilde{s}) = \mathcal{S}(s|s_i)\mathcal{C}(\tilde{s}|s_i) - \mathcal{C}(s|s_i)\mathcal{S}(\tilde{s}|s_i)$$

along with periodicity of the lattice functions β , α

along with considerable algebraic manipulations show that the dispersion function D for the periodic lattice can be expressed as:

$$D(s) = \frac{\sqrt{\beta(s)}}{2 \sin(\sigma_{0x}/2)} \int_s^{s+L_p} d\tilde{s} \frac{\sqrt{\beta(\tilde{s})}}{R(\tilde{s})} \cos[\Delta\psi(\tilde{s}) - \Delta\psi(s) - \sigma_{0x}/2]$$

$$D'(s) = \frac{\alpha(s)}{\beta(s)} D(s)$$

$$= \frac{1}{2\sqrt{\beta(s)} \sin(\sigma_{0x}/2)} \int_s^{s+L_p} d\tilde{s} \frac{\sqrt{\beta(\tilde{s})}}{R(\tilde{s})} \sin[\Delta\psi(\tilde{s}) - \Delta\psi(s) - \sigma_{0x}/2]$$

- ◆ Formulas and related information can be found in SY Lee, *Accelerator Physics* and Conte and MacKay, *Introduction to the Physics of Particle Accelerators*
- ◆ Provides periodic dispersion function D as an integral of betatron function describing the linear optics of the lattice

Full Orbit Resolution in a Periodic Dispersive Lattice

Taking a particle initial condition,

$$\begin{aligned}x(s = s_i) &\equiv x_i & \delta &= \frac{\Delta p}{p_0} \\x'(s = s_i) &\equiv x'_i\end{aligned}$$

and using the homogeneous (Hill's Equation Solution) and particular solutions (Dispersion function) of the periodic lattice, the orbit can be resolved as

$$\begin{aligned}x(s) &= x_h + x_p = x_i C(s|s_i) + x'_i S(s|s_i) + \delta [D(s) - D_i C(s|s_i) - D'_i S(s|s_i)] \\x'(s) &= x'_h + x'_p = x_i C'(s|s_i) + x'_i S'(s|s_i) + \delta [D'(s) - D_i C'(s|s_i) - D'_i S'(s|s_i)]\end{aligned}$$

here,

$$\begin{aligned}D(s = s_i) &\equiv D_i \\D'(s = s_i) &\equiv D'_i\end{aligned}$$

Transfer Matrices for Dispersion Function

In problems, will derive 3x3 transfer matrices:

- ◆ Summarize results here for completeness
- ◆ Can apply to any initial conditions D_i, D'_i
 - Only specific initial conditions will yield D periodic with lattice
 - Useful in general form for applications to transfer lines, achromatic bends, etc.

$$\begin{bmatrix} D \\ D' \\ 1 \end{bmatrix}_s \equiv \mathbf{M}_3(s|s_i) \cdot \begin{bmatrix} D \\ D' \\ 1 \end{bmatrix}_{s_i}$$

Drift: $\kappa_x(s) = 0$

$$\mathbf{M}_3(s|s_i) = \begin{bmatrix} 1 & (s - s_i) & 0 \\ 0 & 1 & 0 \\ 0 & 0 & 1 \end{bmatrix}$$

Thin Lens: located at $s = s_i$ with focal strength f (no superimposed bend)

$$\kappa_x(s) = -\frac{1}{f}\delta(s - s_i)$$
$$\mathbf{M}_3(s_i^+|s_i^-) = \begin{bmatrix} 1 & 0 & 0 \\ -\frac{1}{f} & 1 & 0 \\ 0 & 0 & 1 \end{bmatrix}$$

Thick Focus Lens: with $\kappa_x = \hat{\kappa} = \text{const} > 0$ (no superimposed bend)

$$\mathbf{M}_3(s|s_i) = \begin{bmatrix} \cos[\sqrt{\hat{\kappa}}(s - s_i)] & \frac{1}{\sqrt{\hat{\kappa}}} \sin[\sqrt{\hat{\kappa}}(s - s_i)] & 0 \\ -\sqrt{\hat{\kappa}} \sin[\sqrt{\hat{\kappa}}(s - s_i)] & \cos[\sqrt{\hat{\kappa}}(s - s_i)] & 0 \\ 0 & 0 & 1 \end{bmatrix}$$

Thick deFocus Lens: with $\kappa_x = -\hat{\kappa} = \text{const} < 0$ (no superimposed bend)

$$\mathbf{M}_3(s|s_i) = \begin{bmatrix} \cosh[\sqrt{\hat{\kappa}}(s - s_i)] & \frac{1}{\sqrt{\hat{\kappa}}} \sinh[\sqrt{\hat{\kappa}}(s - s_i)] & 0 \\ \sqrt{\hat{\kappa}} \sinh[\sqrt{\hat{\kappa}}(s - s_i)] & \cosh[\sqrt{\hat{\kappa}}(s - s_i)] & 0 \\ 0 & 0 & 1 \end{bmatrix}$$

Bend with Focusing: $R = \text{const}$, $\kappa_x = \hat{\kappa} = \text{const} > 0$

$$\mathbf{M}_3(s|s_i) = \begin{bmatrix} \cos[\sqrt{\hat{\kappa}}(s - s_i)] & \frac{1}{\sqrt{\hat{\kappa}}} \sin[\sqrt{\hat{\kappa}}(s - s_i)] & \frac{1}{\hat{\kappa}} \left\{ 1 - \cos[\sqrt{\hat{\kappa}}(s - s_i)] \right\} \\ -\sqrt{\hat{\kappa}} \sin[\sqrt{\hat{\kappa}}(s - s_i)] & \cos[\sqrt{\hat{\kappa}}(s - s_i)] & \frac{1}{\sqrt{\hat{\kappa}}} \sin[\sqrt{\hat{\kappa}}(s - s_i)] \\ 0 & 0 & 1 \end{bmatrix}$$

Bend with deFocusing: $R = \text{const}$, $\kappa_x = -\hat{\kappa} = \text{const} < 0$

$$\mathbf{M}_3(s|s_i) = \begin{bmatrix} \cosh[\sqrt{\hat{\kappa}}(s - s_i)] & \frac{1}{\sqrt{\hat{\kappa}}} \sinh[\sqrt{\hat{\kappa}}(s - s_i)] & \frac{1}{R\hat{\kappa}} \left\{ -1 + \cosh[\sqrt{\hat{\kappa}}(s - s_i)] \right\} \\ \sqrt{\hat{\kappa}} \sinh[\sqrt{\hat{\kappa}}(s - s_i)] & \cosh[\sqrt{\hat{\kappa}}(s - s_i)] & \frac{1}{R\sqrt{\hat{\kappa}}} \sinh[\sqrt{\hat{\kappa}}(s - s_i)] \\ 0 & 0 & 1 \end{bmatrix}$$

For the special case of a [sector bend](#) of axial length ℓ the bend with focusing result reduces for transport through the full bend to:

$$\ell = R\theta, \quad \theta = \text{Bend Angle}$$

$$\mathbf{M}_3 = \begin{bmatrix} \cos \theta & R \sin \theta & R(1 - \cos \theta) \\ -\frac{\sin \theta}{R} & \cos \theta & \sin \theta \\ 0 & 0 & 1 \end{bmatrix}$$

For a small angle bend with $|\theta| \ll 1$ this further reduces to:

$$\mathbf{M}_3 \simeq \begin{bmatrix} 1 & \ell & \ell\theta/2 \\ 0 & 1 & \theta \\ 0 & 0 & 1 \end{bmatrix}$$

// Example: Dispersion function for a simple periodic lattice

For purposes of a simple illustration we here use an imaginary FO (Focus-Drift) piecewise-constant lattice where the x -plane focusing is like the focus-plane of a quadrupole with one thick lens focus optic per lattice period and a single drift with the bend in the middle of the drift

- ◆ Focus element implemented by $\kappa > 0$ x -plane quadrupole transfer matrix in **S5B**.

$$\begin{array}{ll} L_p = 0.5 \text{ m} & \kappa = 20/\text{m}^2 \text{ in Focusing} \\ \eta = 0.5 & R = 15 \text{ m, in bend, 25\% Occupancy} \end{array}$$

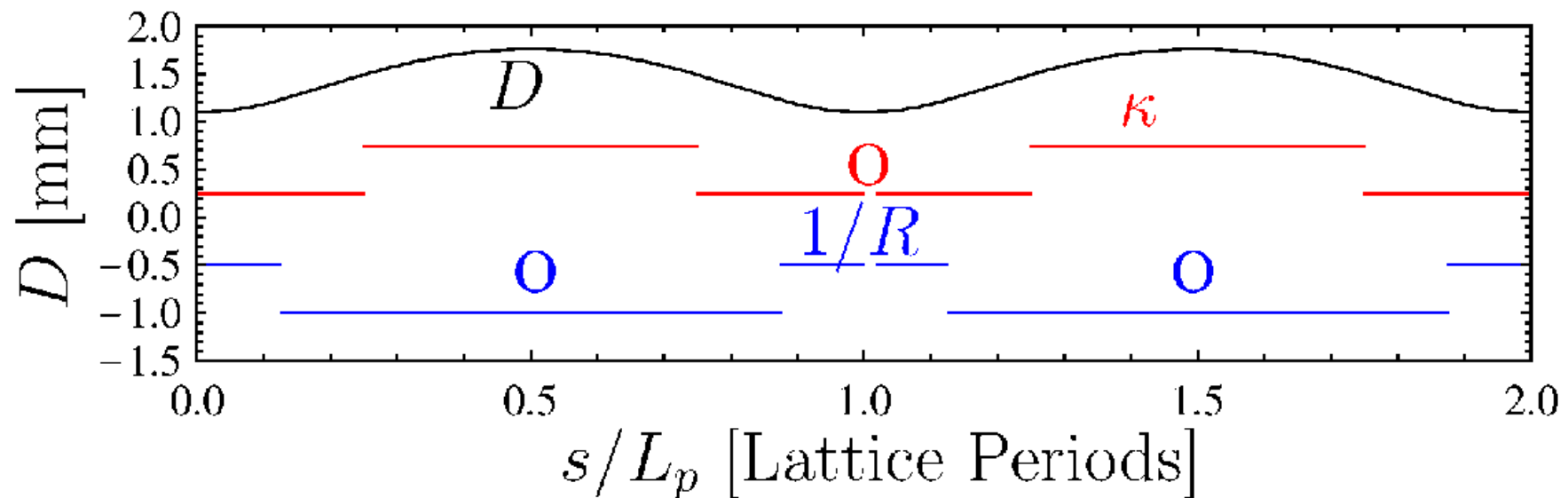

//

// Example: Dispersion broadens the distribution in x

Uniform Bundle of particles $D = 0$

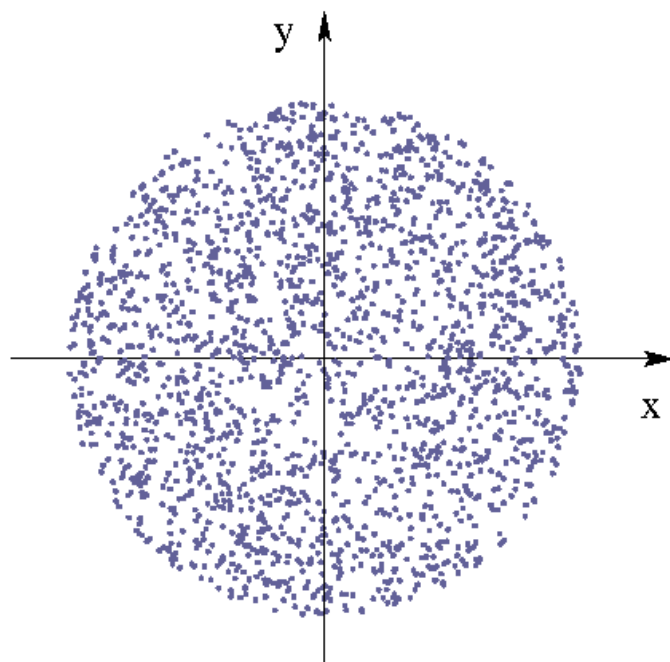

Same Bundle of particles D nonzero

- ◆ Gaussian distribution of momentum spread distorts the x - y distribution extends in x but not in y

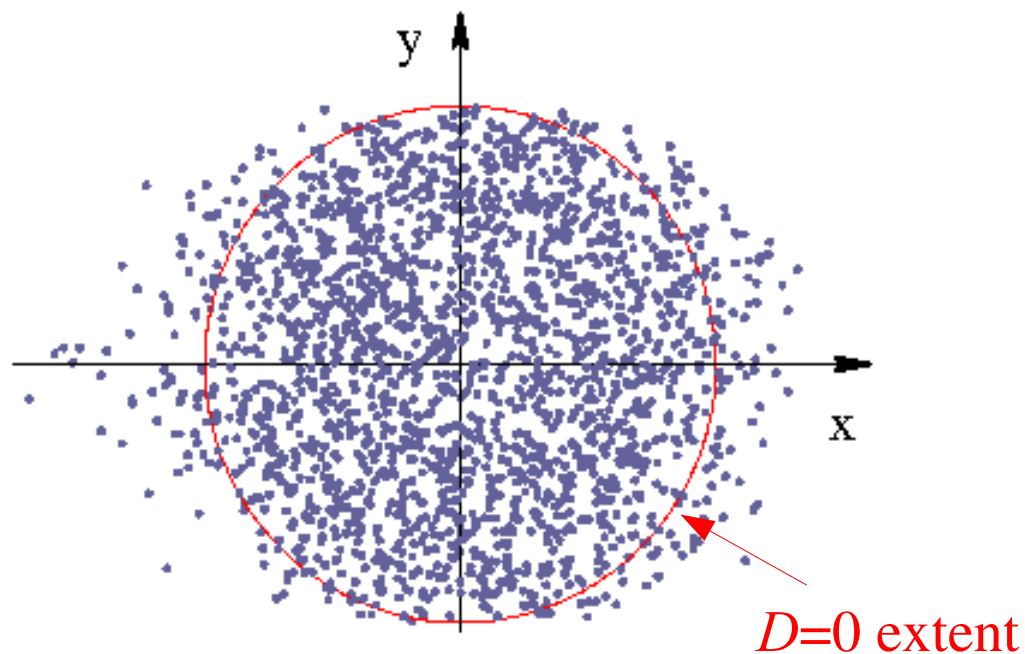

//

// Example: Continuous Focusing in a Continuous Bend

$$\kappa_x(s) = k_{\beta 0}^2 = \text{const}$$

$$R(s) = R = \text{const}$$

Dispersion equation becomes:

$$D'' + k_{\beta 0}^2 D = \frac{1}{R}$$

With constant solution:

$$D = \frac{1}{k_{\beta 0}^2 R} = \text{const}$$

From this result we can crudely estimate the average value of the dispersion function in a ring with periodic focusing by taking:

R = Avg Radius Ring

L_p = Lattice Period (Focusing)

σ_{0x} = x -Plane Phase Advance

$$\implies k_{\beta 0} \sim \frac{\sigma_0}{L_p} \implies D \sim \frac{L_p^2}{\sigma_0^2 R}$$

//

Many **rings** are designed to focus the dispersion function $D(s)$ to small values in straight sections even though the lattice has strong bends

- ◆ Desirable since it allows smaller beam extents at locations near where $D = 0$ and these locations can be used to insert and extract (kick) the beam into and out of the ring with minimal losses and/or accelerate the beam
 - Since average value of D is dictated by ring size and focusing strength (see example next page) this variation in values can lead to D being larger in other parts of the ring
- ◆ Quadrupole triplet focusing lattices are often employed in rings since the use of 3 optics per period (vs 2 in doublet) allows more flexibility to tune D while simultaneously allowing particle phase advances to also be adjusted

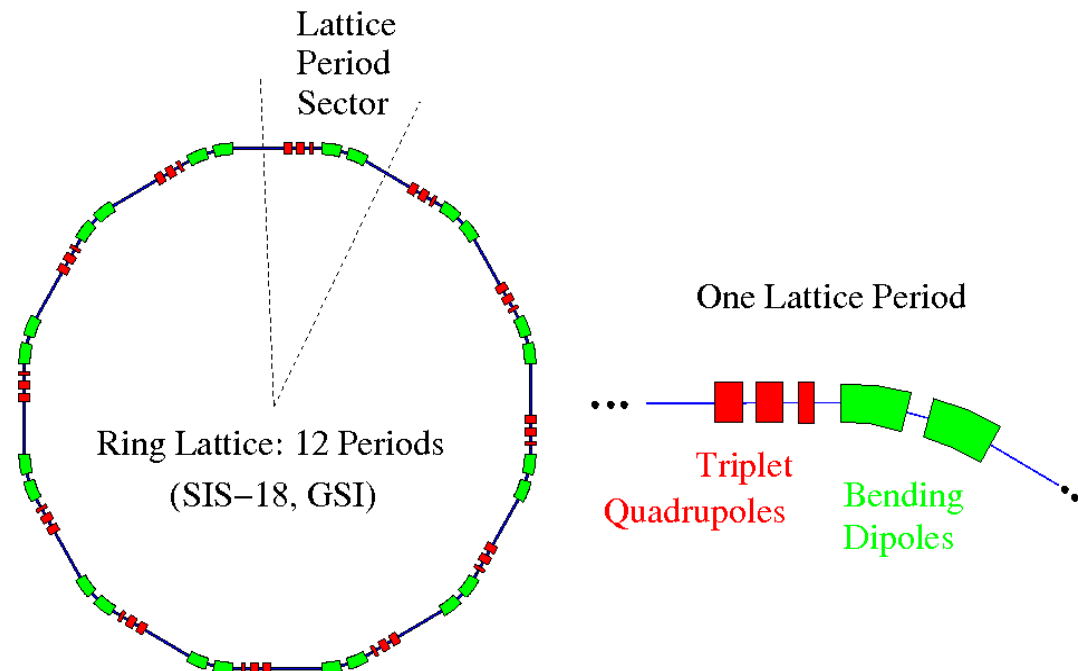

Dispersive Effects in Transfer Lines with Bends

It is common that a beam is transported through a single or series of bends in applications rather than a periodic ring lattice. In such situations, dispersive corrections to the particle orbit are analyzed differently. In this case, the same particular + homogeneous solution decomposition is used as in the ring case with the Dispersion function satisfying:

$$D''(s) + \kappa_x(s)D(s) = \frac{1}{R(s)}$$

However, in this case D is solved from an initial condition. Usually (but not always) from a dispersion-free initial condition $s = s_i$ upstream of the bends with:

$$D(s_i) = 0 = D'(s_i)$$

If the bends and focusing elements can be configured such that on transport through the bend ($s = s_d$) that

$$D(s_d) = 0 = D'(s_d)$$

Then the bend system is **first order achromatic** meaning there will be no final orbit deviation to 1st order in δ on traversing the system.

This equation has the form of a *Driven Hill's Equation*:

$$x'' + \kappa(s)x = p(s)$$

$$x \rightarrow D$$

$$p \rightarrow 1/R$$

The general solution to this equation can be solved analytically using a Green function method (see [Appendix A](#)) based on principle orbits of the homogeneous Hill's equation as:

$$x(s) = x(s_i)\mathcal{C}(s|s_i) + x'(s_i)\mathcal{S}(s|s_i) + \int_{s_i}^s d\tilde{s} G(s, \tilde{s})p(\tilde{s})$$

$$G(s, \tilde{s}) = \mathcal{S}(s|s_i)\mathcal{C}(\tilde{s}|s_i) - \mathcal{C}(s|s_i)\mathcal{S}(\tilde{s}|s_i)$$

Cosine-Like Solution

$$\mathcal{C}''(s|s_i) + \kappa(s)\mathcal{C}(s|s_i) = 0$$

$$\mathcal{C}(s_i|s_i) = 1$$

$$\mathcal{C}'(s_i|s_i) = 0$$

Sine-Like Solution

$$\mathcal{S}''(s|s_i) + \kappa(s)\mathcal{S}(s|s_i) = 0$$

$$\mathcal{S}(s_i|s_i) = 0$$

$$\mathcal{S}'(s_i|s_i) = 1$$

$$x(s_i) = \text{Initial value } x$$

$$x'(s_i) = \text{Initial value } x'$$

Green function effectively casts driven equation in terms of homogeneous solution projections of Hill's equation.

Using this Green function solution from the dispersion-free initial condition gives

$$D(s) = \mathcal{S}(s|s_i) \int_{s_i}^s d\tilde{s} \frac{1}{R(\tilde{s})} \mathcal{C}(\tilde{s}|s_i) - \mathcal{C}(s|s_i) \int_{s_i}^s d\tilde{s} \frac{1}{R(\tilde{s})} \mathcal{S}(\tilde{s}|s_i)$$

$\mathcal{C}(s|s_i)$ = Cosine-like Principal Trajectory

$\mathcal{S}(s|s_i)$ = Sine-like Principal Trajectory

- ♦ Alternatively, the 3x3 transfer matrices previously derived can also be applied to advance D from a dispersion free point in the the linear lattice

The full particle orbit consistent with dispersive effects is given by

$$\begin{aligned} x(s) &= x(s_i)\mathcal{C}(s|s_i) + x'(s_i)\mathcal{S}(s|s_i) + \delta D(s) \\ x'(s) &= x(s_i)\mathcal{C}'(s|s_i) + x'(s_i)\mathcal{S}'(s|s_i) + \delta D'(s) \end{aligned}$$

For a 1st order achromatic system we require for no leading-order dispersive corrections to the orbit on transiting the lattice ($s_i \rightarrow s_d$). This requires:

$$0 = \int_{s_i}^{s_d} d\tilde{s} \frac{1}{R(\tilde{s})} \mathcal{C}(\tilde{s}|s_i)$$

$$0 = \int_{s_i}^{s_d} d\tilde{s} \frac{1}{R(\tilde{s})} \mathcal{S}(\tilde{s}|s_i)$$

Various lattices consisting of regular combinations of bends and focusing optics can be made achromatic to 1st order by meeting these criteria.

- Higher-order achromats also possible under more detailed analysis. See, for examples: Rusthoi and Wadlinger, 1991 PAC, 607

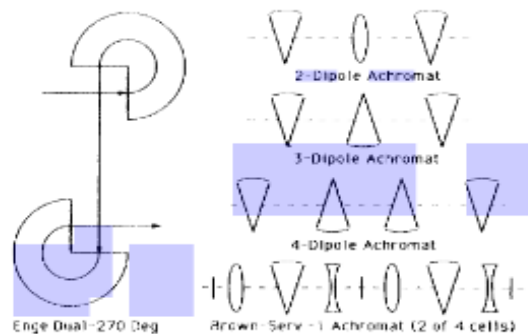

Figure 1. First-order achromats.

Examples are provided in the following slides for achromatic bends as well as bend systems to maximize/manipulate dispersive properties for species separation. Further examples can be found in the literature

Symmetries in Achromatic Lattice Design

Input from C.Y. Wong, MSU

Symmetries are commonly exploited in the design of achromatic lattices to:

- ◆ Simplify the lattice design
- ◆ Reproduce (symmetrically) initial beam conditions downstream

Example lattices will be given after discussing general strategies:

Approach 1: beam line with reflection symmetry about its mid-plane

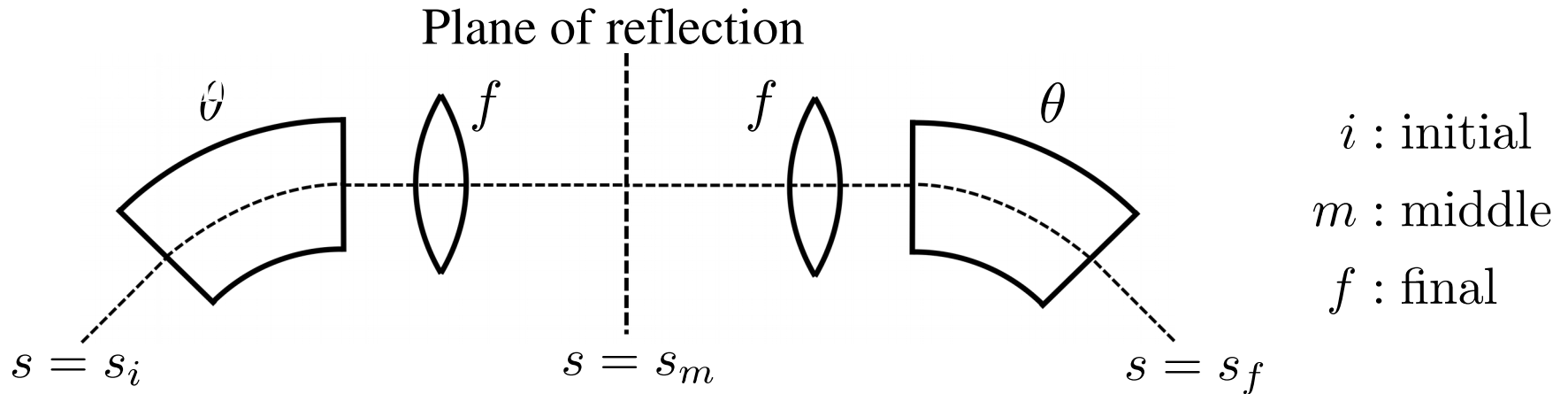

If $g'(s_m) = 0$, then $g(s_i) = g(s_f)$, $g'(s_i) = -g'(s_f)$

where g can be β_x , β_y or D

After the mid-plane, the beam traverses the same lattice elements in reverse order. So if the lattice function angle (d/ds) vanishes at mid-plane, the lattice function undergoes “time reversal” in the 2nd half of the beam line exiting downstream at the symmetric axial location with the same initial value and opposite initial angle.

Approach 2: beam line with rotational symmetry about the mid-point:

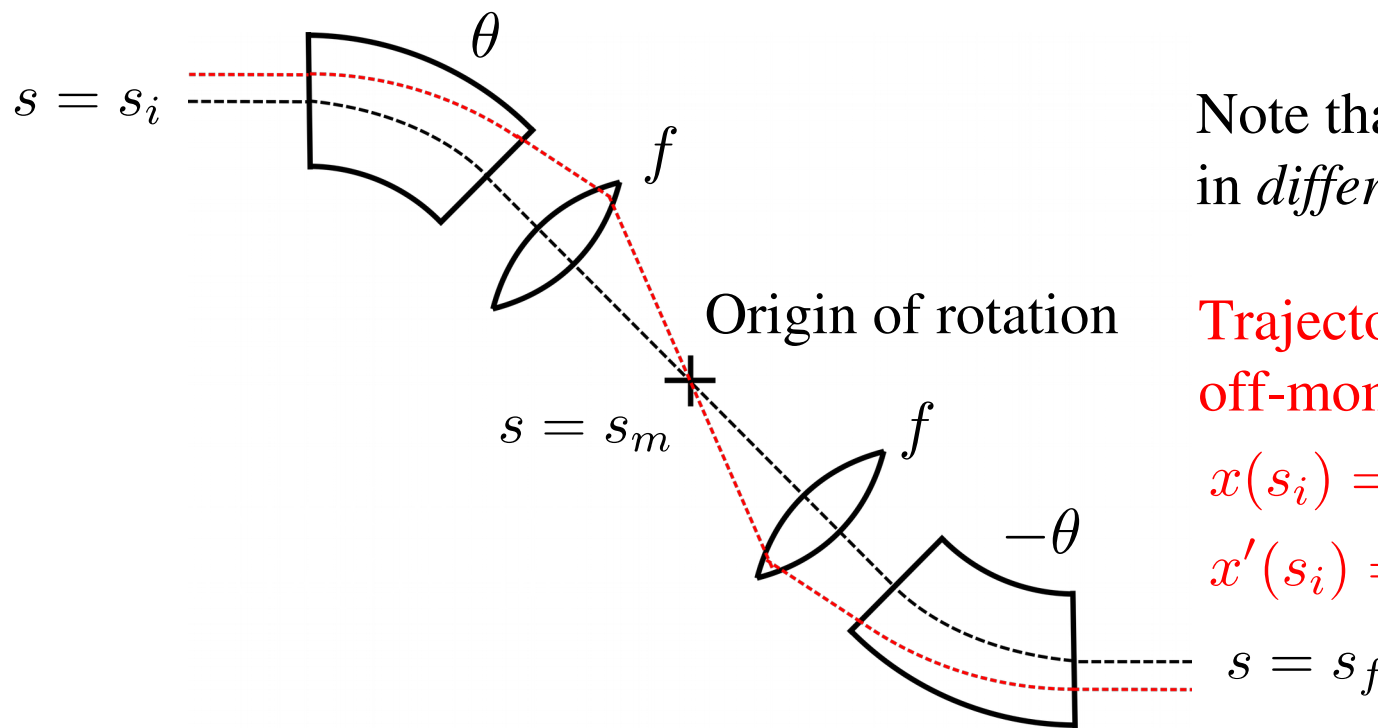

Note that the dipoles bend in *different* directions

Trajectory in red: ideal off-momentum particle

$$x(s_i) = D(s_i)\delta \neq 0$$

$$x'(s_i) = D'(s_i)\delta = 0$$

Focusing properties of dipoles are independent of bend direction (sign θ).

Same reasoning as Approach 1 gives:

$$\text{If } \beta'_{x,y}(s_m) = 0, \quad \text{then } \beta_{x,y}(s_i) = \beta_{x,y}(s_f), \quad \beta'_{x,y}(s_i) = -\beta'_{x,y}(s_f)$$

Dispersive properties of dipoles change with bend direction. See **Appendix C**.

$$\text{If } D(s_m) = 0 \text{ (instead of } D'), \quad \text{then } D(s_i) = -D(s_f), \quad D'(s_i) = D'(s_f)$$

If D vanishes at mid-plane, the dispersive shift of an off-momentum particle also exhibits rotational symmetry about the mid-point

Example: Achromatic Bend with Thin Lens Focusing

Input from C.Y. Wong, MSU

Apply Approach 1 with simple round numbers:

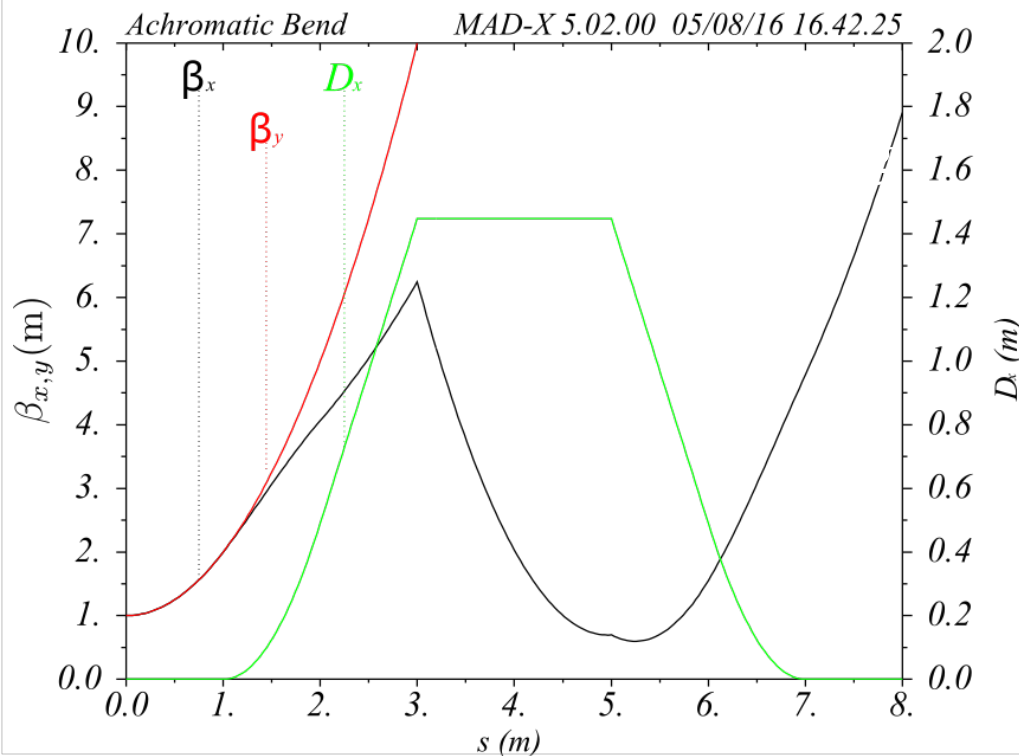
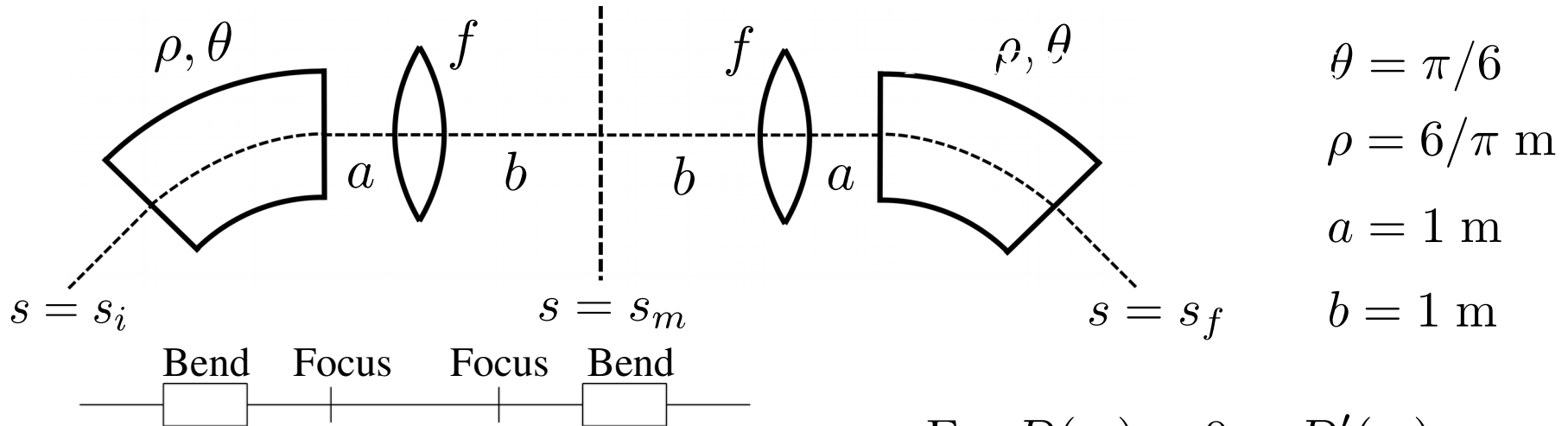

For $D(s_i) = 0 = D'(s_i)$,

$$D'(s_m) = 0 \text{ if } f = \rho \tan \frac{\theta}{2} + a$$

(see next slide)

$$\Rightarrow f = 1.51 \text{ m}$$

The bending system is achromatic, but the betatron functions are asymmetric due to insufficient lattice parameters to tune.

- Add more elements to address

For incident beam with $D(s_i) = 0 = D'(s_i)$, the dispersion function only evolves once the beam enters the dipole

$$\begin{pmatrix} D \\ D' \\ 1 \end{pmatrix}_{s_m} = \begin{pmatrix} 1 & b & 0 \\ 0 & 1 & 0 \\ 0 & 0 & 1 \end{pmatrix} \begin{pmatrix} D \\ D' \\ 1 \end{pmatrix}_{s_m - b} = \begin{pmatrix} 1 & b & 0 \\ 0 & 1 & 0 \\ 0 & 0 & 1 \end{pmatrix} \mathbf{M} \begin{pmatrix} 0 \\ 0 \\ 1 \end{pmatrix}$$

where

$$\mathbf{M} = \begin{pmatrix} 1 & 0 & 0 \\ -\frac{1}{f} & 1 & 0 \\ 0 & 0 & 1 \end{pmatrix} \begin{pmatrix} 1 & a & 0 \\ 0 & 1 & 0 \\ 0 & 0 & 1 \end{pmatrix} \begin{pmatrix} \cos \theta & \rho \sin \theta & \rho(1 - \cos \theta) \\ -\frac{\sin \theta}{\rho} & \cos \theta & \sin \theta \\ 0 & 0 & 1 \end{pmatrix}$$

Note that the drift b after the thin lens focus does not affect D'

$$D'(s_m) = D'(s_m - b) = 0 \text{ if } M_{23} = 0$$

Solution gives:

$$\implies f = \rho \tan \frac{\theta}{2} + a$$

Discussion:

- ◆ Only have to design half the beam-line by exploiting symmetries:
 - One constraint at mid-point satisfies two constraints at the end of the beam line if an asymmetric design approach was taken
 - Symmetric lattice easier to set/tune: strengths in 1st half of the beam line identical to mirror pair in the 2nd half
- ◆ It is *possible* to achieve the same final conditions with an asymmetric beam line, but this is generally not preferred
- ◆ There should be more lattice strength parameters that can be turned than constraints – needs more optics elements than this simple example
 - ◆ Except in simplest of cases, parameters often found using numerical procedures and optimization criteria

Discussion Continued:

- ◆ Usually [Approach 1](#) and [Approach 2](#) are applied for transfer line bends with

$$D(s_i) = 0 = D(s_f), \quad D'(s_i) = 0 = D'(s_f)$$

However, this is not necessary

- ◆ Common applications with $D(s_i) = 0 = D'(s_i)$ for linacs and transfer lines:
 - [Approach 1](#): fold a linac, or create dispersion at mid-plane to collimate / select species from a multi-species beam
 - [Approach 2](#): translate the beam
- ◆ Common applications for rings:
 - [Approach 1](#): Minimize dispersion in straight sections to reduce aberrations in RF cavities, wigglers/undulators, injection/extraction, etc.
- ◆ Not only is it desirable to minimize the dispersion at cavities for acceleration purposes, an accelerating section has no effect on the dispersion function up to 1st order only if $D = D' = 0$
 - Consider an off-momentum particle with $x'_D = \delta D' = 0$, $x_D = \delta D \neq 0$ undergoing purely longitudinal acceleration
 - δ changes while x_D does not, while entails that D changes

Example: Simplified Fragment Separator

Input from C.Y. Wong, MSU

Heavy ion beams impinge on a production target to produce isotopes for nuclear physics research. Since many isotopes are produced, a fragment separator is needed downstream to serve two purposes:

- ◆ Eliminate unwanted isotopes
- ◆ Select and focus isotope of interest onto a transport line to detectors

Different isotopes have different rigidities, which are exploited to achieve isotope selection

$$\text{Rigidity } [B\rho] = \frac{p}{q} = \frac{\gamma m v}{q}$$

ref particle (isotope) sets parameters in lattice transfer matrices

$$\delta = \left(\frac{\Delta p}{p} \right)_{\text{eff}} = \frac{\Delta[B\rho]}{[B\rho]_0}$$

Deviation from the reference rigidity treated as an effective momentum difference

- ◆ Applied fields fixed for all species

Dispersion exploited to collimate off-rigidity fragments

NSCL A1900 Fragment Separator: Simplified Illustration

A1900 schematic

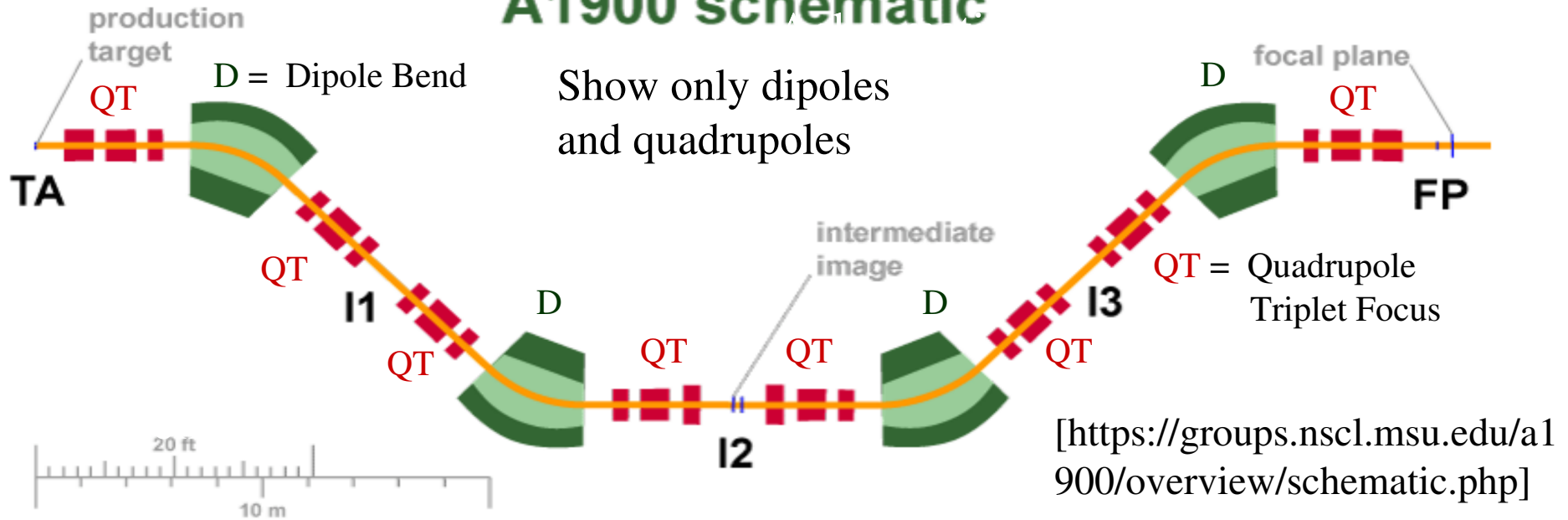

Further Simplified Example: 2 segment version

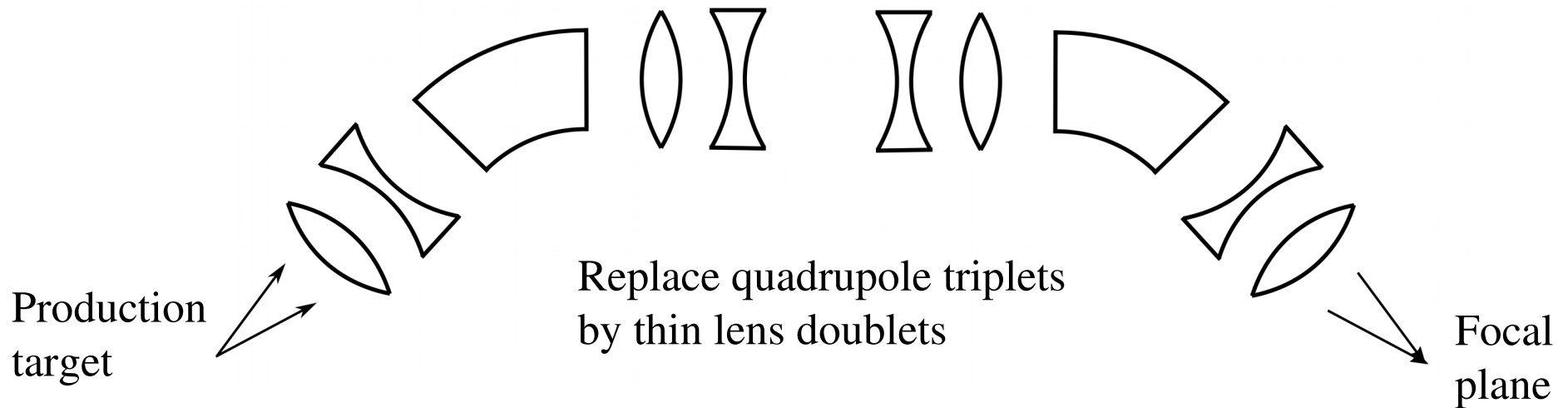

Design Goals:

- ◆ Dipoles set so desired isotope traverses center of all elements
- ◆ Dispersion function D is: *large at collimation* for rigidity resolution
small elsewhere to minimize losses
- ◆ β_x β_y should be small at collimation point and focal plane

Apply Approach 1 by requiring $D' = \beta'_x = \beta'_y = 0$ at mid-plane

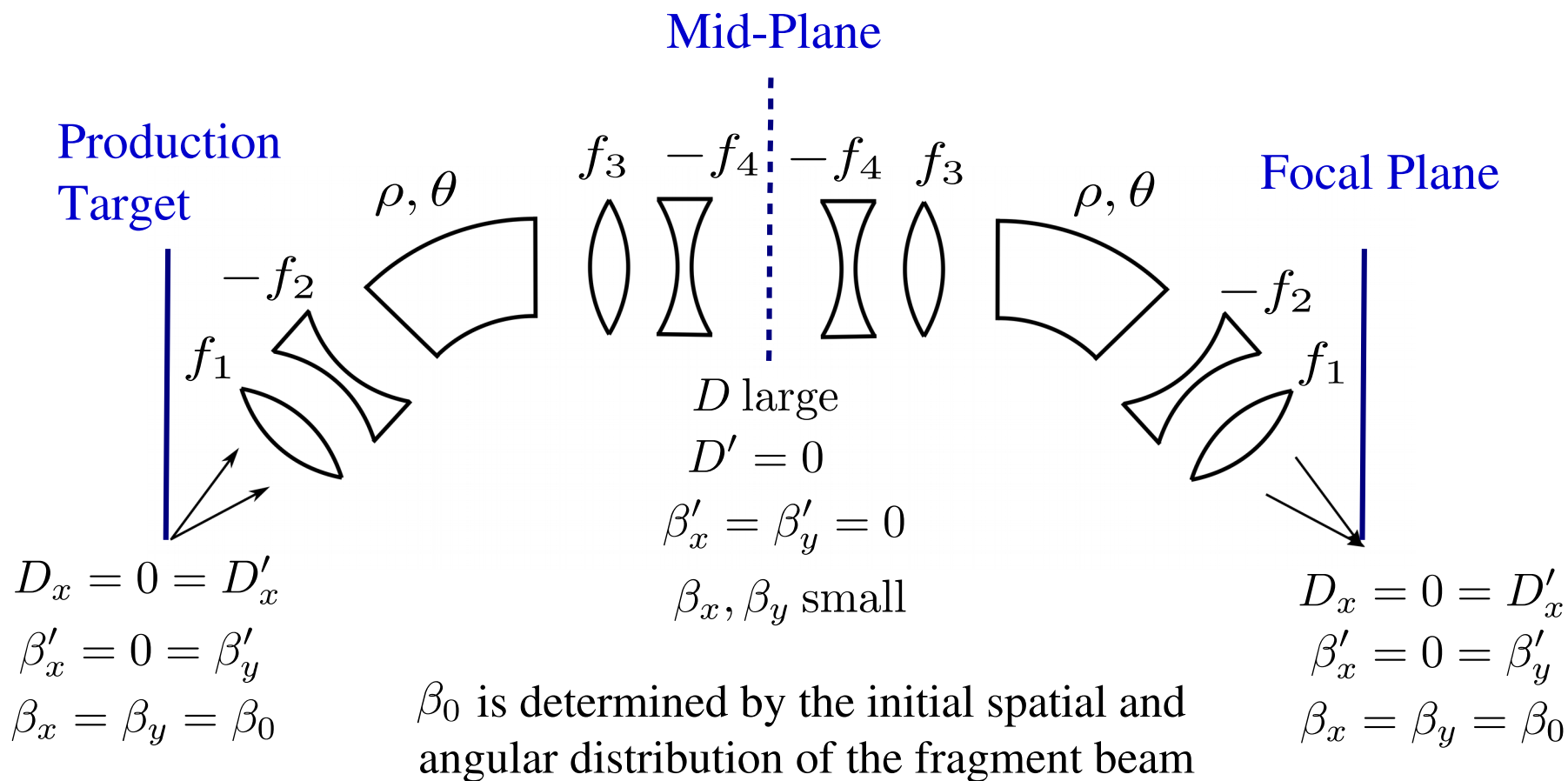

Supplementary: Parameters for Simplified Fragment Separator

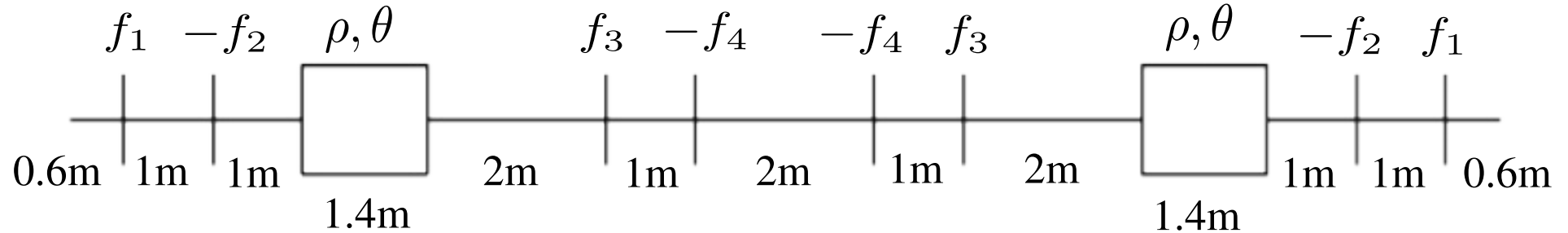

Desired isotope: $^{31}\text{S}^{16+}$ from $^{40}\text{Ar}(140 \text{ MeV/u})$ on Be target

Energy: 120 MeV/u

Rigidity: 3.15 Tesla-m

Initial conditions at production target:

$$\sqrt{\langle x^2 \rangle} = 1 \text{ mm} \quad \sqrt{\langle x'^2 \rangle} = 10 \text{ mrad}$$

$$\epsilon_x = 10 \text{ mm-mrad}$$

Dipole ρ, θ are fixed

$$\rho = 1.78 \text{ m} \quad \theta = \pi/4$$

Thus $B_y(0)$ is uniquely determined by $[B\rho]$

$$B_y(0) = 1.7 \text{ Tesla}$$

Impose constraints and solve f 's numerically:

$$f_1 = 1.12 \text{ m} \quad \text{Quadrupole} \quad G_1 = 13.9 \text{ T/m}$$

$$f_2 = f_1 \quad \text{gradients} \quad G_2 = 13.9 \text{ T/m}$$

$$f_3 = 1.79 \text{ m} \quad \iff \quad G_3 = 8.7 \text{ T/m}$$

$$f_4 = 4.17 \text{ m} \quad \text{for lengths} \quad G_4 = 3.7 \text{ T/m}$$

$$\ell = 20 \text{ cm}$$

For other isotopes:

If initial $\langle x^2 \rangle, \langle x'^2 \rangle$ are same, scale all fields to match rigidity $[B\rho]$

If not, the f 's also have to be re-tuned to meet the constraints

Lattice functions and beam envelope

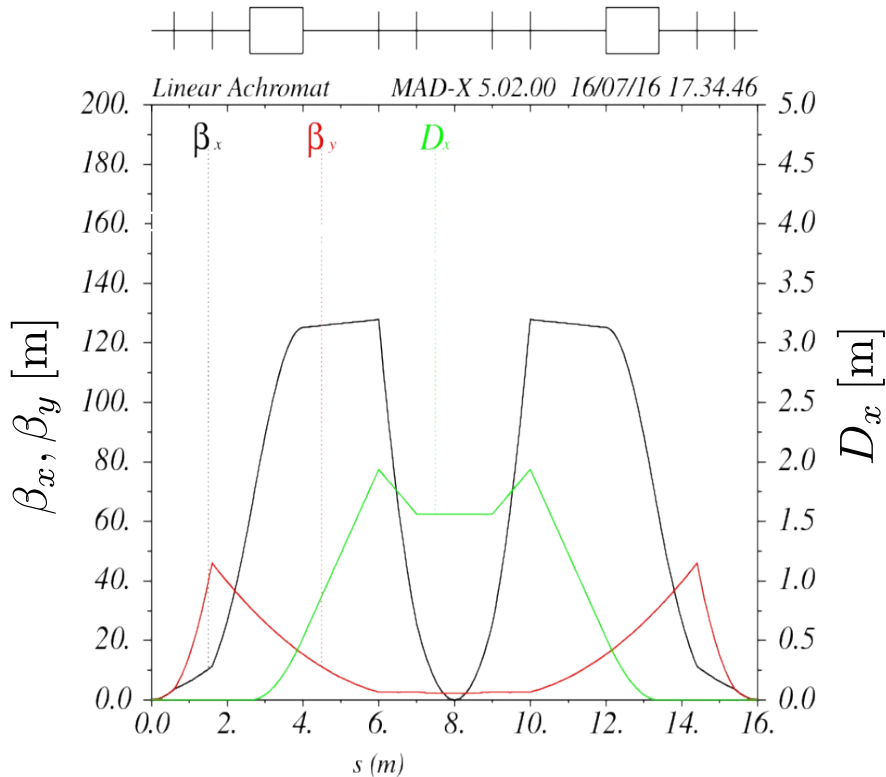

◆ Slits at mid-plane where dispersion large to collimate unwanted isotopes and discriminate momentum

◆ x-envelope plotted for 3 momentum values:

$$x_{\text{env}} = \pm \sqrt{\beta_x \epsilon_x} + \delta D$$

◆ Aperture sizes and D (properties of lattice), determine the angular and momentum acceptance of the fragment separator

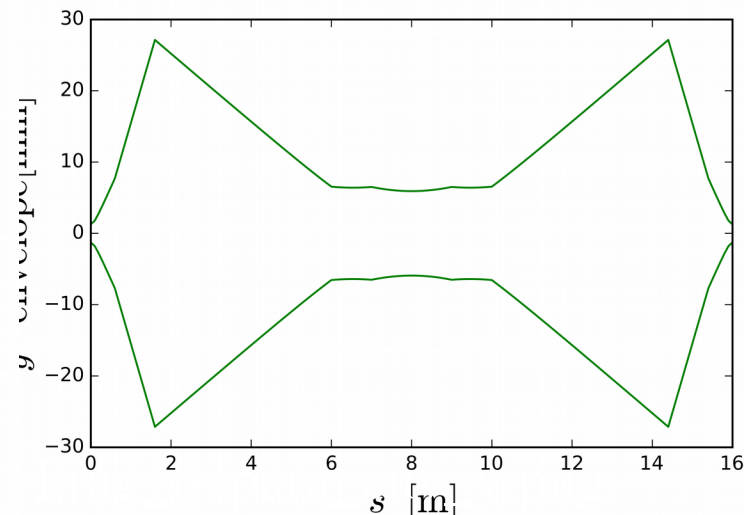
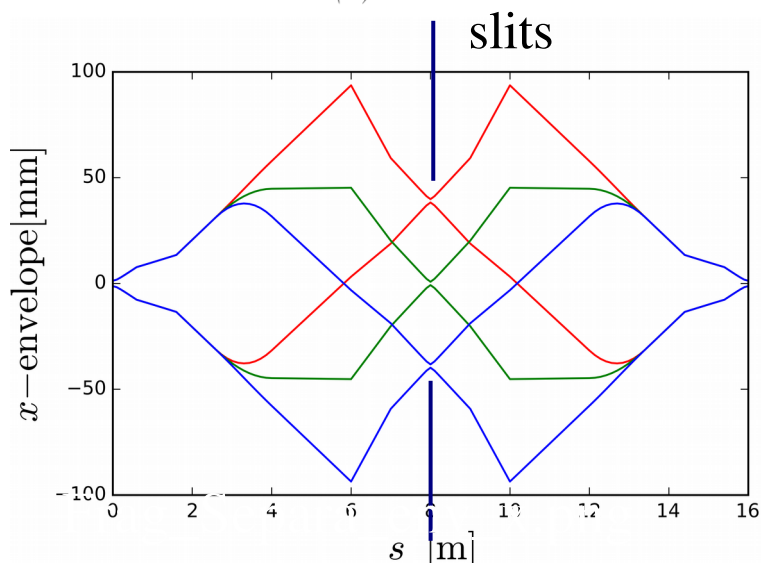

$\delta p/p = 2.5\%$

$\delta p/p = 0$

$\delta p/p = -2.5\%$

Example: Charge Selection System of the FRIB Front End

Input from C.Y. Wong, MSU

An ECR ion source produces a many-species beam

A charge selection system (CSS) is placed shortly downstream of each source to select the desired species for further transport and collimate the rest

- ◆ The CSS consists of two quadrupole triplets and two 90-degree sector dipoles
- ◆ The dipoles have slanted poles applied to increase x-focusing to enhance dispersion in the CSS

FRIB CSS

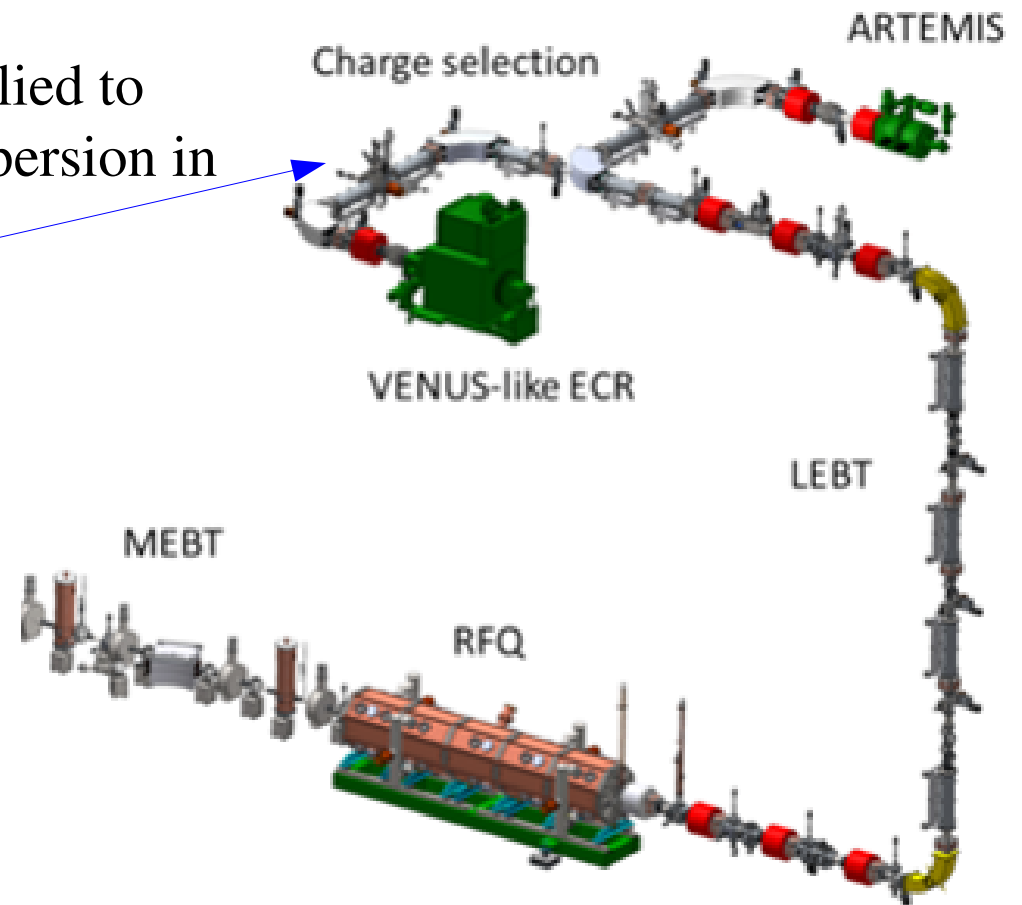
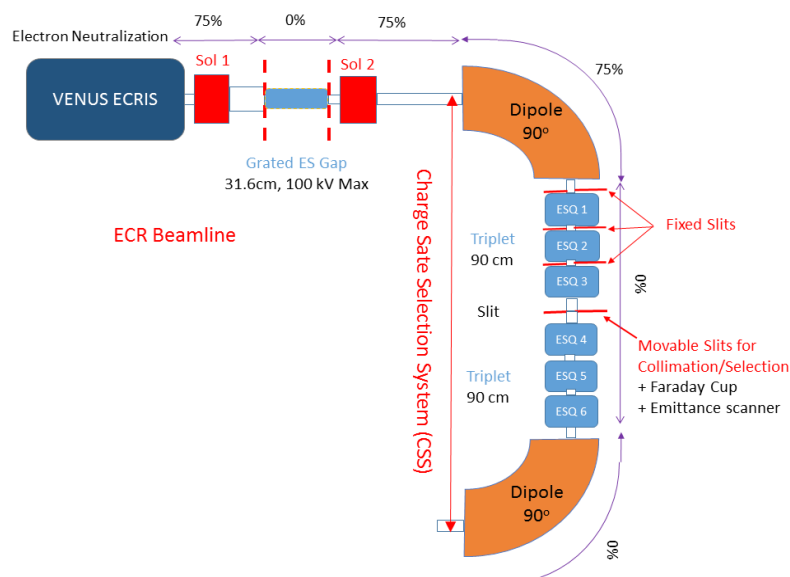

Parameters for the CSS

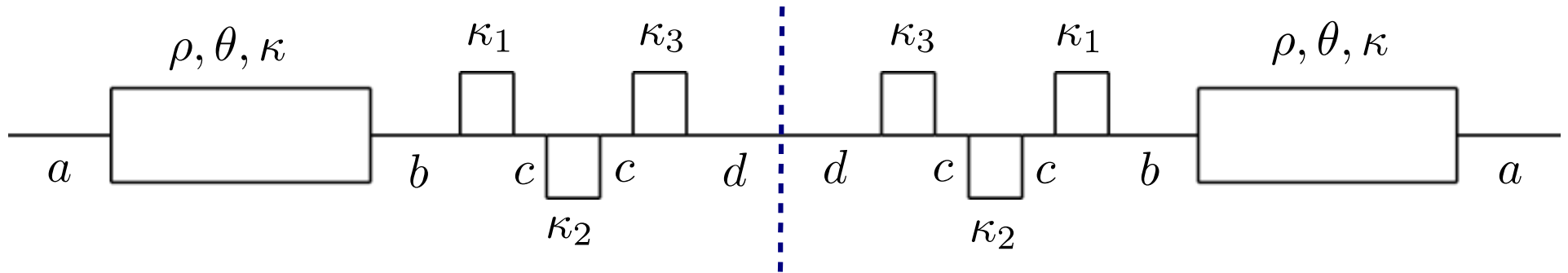

Dipole:

$$\theta = \pi/2 \quad \rho = 2/\pi \text{ m}$$

$$\kappa_x = 0.1/\rho^2 \quad \kappa_y = 0.9/\rho^2$$

where field index $n = 0.9$ from : $x'' + \kappa_x x = x'' + \frac{1-n}{\rho^2} x = 0$

Mid-plane conditions:

$$\alpha_x(s_m) = \alpha_y(s_m) = D' = 0$$

$$y'' + \kappa_y y = y'' + \frac{n}{\rho^2} y = 0$$

Quadrupoles:

$$l_{\text{quad}} = 0.2 \text{ m}$$

$$\kappa_{1x} = -\kappa_{1y} = 8.30 \text{ m}^{-2}$$

$$\kappa_{2x} = -\kappa_{2y} = -15.60 \text{ m}^{-2}$$

$$\kappa_{3x} = -\kappa_{3y} = 7.51 \text{ m}^{-2}$$

Drifts:

$$a = 0.4 \text{ m}$$

$$b = 0.35 \text{ m}$$

$$c = 0.13 \text{ m}$$

$$d = 0.19 \text{ m}$$

Initial Conditions:

$$\beta_x(s_i) = \beta_y(s_i) = 3.971 \text{ m}$$

$$\alpha_x(s_i) = \alpha_y(s_i) = -0.380$$

$$D(s_i) = D'(s_i) = 0$$

Lattice Functions of CSS

Large dispersion and small beam size in x at mid-plane facilitates the collimation of unwanted species

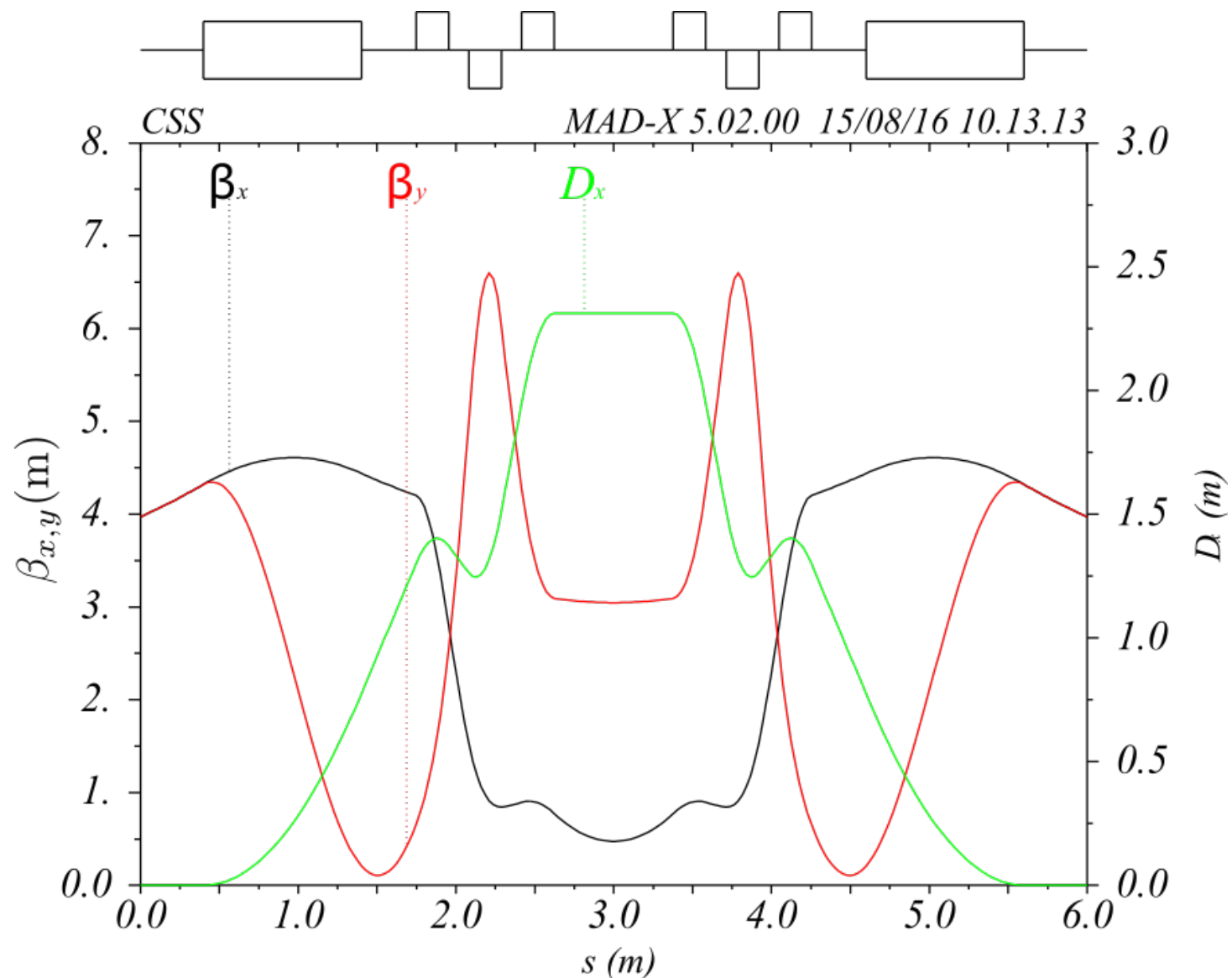

S9C: Chromatic Effects

Present in both x - and y -equations of motion and result from applied focusing strength changing with deviations in momentum:

$$x''(s) + \frac{\kappa_x(s)}{(1 + \delta)^n} x(s) = 0$$

$$R \rightarrow \infty$$

$$y''(s) + \frac{\kappa_y(s)}{(1 + \delta)^n} y(s) = 0$$

to neglect bending terms

$\kappa_{x,y}$ = Focusing Functions
with γ_b, β_b calculated from p_0

- ◆ Generally of lesser importance (smaller corrections) relative to dispersive terms (**S9C**) in linacs *except* where the beam is focused onto a target (small spot) or when momentum spreads are large
- ◆ Can be important in rings where precise control of tunes (betatron oscillations per ring lap) are needed to avoid resonances: see Transverse Particle Resonances
- ◆ J.J. Barnard in **Application Lectures: Heavy Ion Fusion and Final Focusing** will overview consequences of chromatic effects on the achievable beam spot in his analysis on final focus optics

Can analyze by redefining kappa function to incorporate off-momentum:

$$\frac{\kappa_x(s)}{(1 + \delta)^n} \rightarrow \kappa_{x,\text{new}}(s)$$

However, this would require calculating new amplitude/betatron functions for each particle off-momentum value δ in the distribution to describe the evolution of the orbits. That would not be efficient.

Rather, need a perturbative formula to calculate the small amplitude correction to the nominal particle orbit with design momentum due to the small amplitude correction due to the off-momentum δ .

Either the x - and y -equations of motion can be put in the form:

$$x''(s) + \frac{\kappa(s)}{(1 + \delta)^n} x(s) = 0$$

Expand to leading order in δ :

$$x''(s) + \kappa(s)(1 - n\delta)x(s) = 0$$

Set:

$$x(s) = x_0(s) + \eta(s) \quad \begin{array}{l} x_0(s) = \text{Orbit Solution for } \delta = 0 \\ \eta(s) = \text{Orbit Correction to } x_0 \text{ for } \delta \neq 0 \end{array}$$

Giving:

$$\begin{aligned} x_0'' + \kappa x_0 &= 0 \\ (x_0 + \eta)'' + \kappa(1 - n\delta)(x_0 + \eta) &= 0 \end{aligned}$$

Subtract equations and neglect 2nd order term in $\delta \cdot \eta$ to obtain a linear equation for η :

$$\eta'' + \kappa\eta = n\delta\kappa x_0$$

This equation has the form of a *Driven Hill's Equation*:

$$x'' + \kappa(s)x = p(s)$$

$$x \rightarrow \eta$$

$$p \rightarrow n\delta\kappa x_0$$

The general solution to this equation can be solved analytically using a Green function method (see [Appendix A](#)) as:

$$x(s) = x(s_i)\mathcal{C}(s|s_i) + x'(s_i)\mathcal{S}(s|s_i) + \int_{s_i}^s d\tilde{s} G(s, \tilde{s})p(\tilde{s})$$

$$G(s, \tilde{s}) = \mathcal{S}(s|s_i)\mathcal{C}(\tilde{s}|s_i) - \mathcal{C}(s|s_i)\mathcal{S}(\tilde{s}|s_i)$$

Cosine-Like Solution

$$\mathcal{C}''(s|s_i) + \kappa(s)\mathcal{C}(s|s_i) = 0$$

$$\mathcal{C}(s_i|s_i) = 1$$

$$\mathcal{C}'(s_i|s_i) = 0$$

Sine-Like Solution

$$\mathcal{S}''(s|s_i) + \kappa(s)\mathcal{S}(s|s_i) = 0$$

$$\mathcal{S}(s_i|s_i) = 0$$

$$\mathcal{S}'(s_i|s_i) = 1$$

$$x(s_i) = \text{Initial value } x$$

$$x'(s_i) = \text{Initial value } x'$$

Using this result, the general solution for the chromatic correction to the particle orbit can be expressed as:

$$\eta(s) = \eta(s_i)\mathcal{C}(s|s_i) + \eta'(s_i)\mathcal{S}(s|s_i) + n\delta \int_{s_i}^s d\tilde{s} G(s, \tilde{s})\kappa(\tilde{s})x_0(\tilde{s})$$

$$G(s, \tilde{s}) = \mathcal{S}(s|s_i)\mathcal{C}(\tilde{s}|s_i) - \mathcal{C}(s|s_i)\mathcal{S}(\tilde{s}|s_i)$$

$$\eta(s_i) = \text{Initial value } \eta$$

$$\eta'(s_i) = \text{Initial value } \eta'$$

Chromatic orbit perturbations are typically measured from a point in the lattice where they are initially zero like a drift where the orbit was correct before focusing quadrupoles. In this context, can take:

$$\eta(s_i) = 0 = \eta'(s_i)$$

$$\eta(s) = n\delta \int_{s_i}^s d\tilde{s} G(s, \tilde{s}) \kappa(\tilde{s}) x_0(\tilde{s})$$

The Green function can be simplified using results from **S6F**:

$$C(s|s_i) = \frac{w(s)}{w_i} \cos \Delta\psi(s) - w'_i w(s) \sin \Delta\psi(s)$$

$$\Delta\psi(s) \equiv \int_{s_i}^s \frac{d\tilde{s}}{w^2(\tilde{s})}$$

$$S(s|s_i) = w_i w(s) \sin \Delta\psi(s)$$

$$w_i \equiv w(s = s_i)$$

$$w'_i \equiv w'(s = s_i)$$

Giving after some algebra:

$$\begin{aligned} G(s, \tilde{s}) &= \mathcal{S}(s|s_i)\mathcal{C}(\tilde{s}|s_i) - \mathcal{C}(s|s_i)\mathcal{S}(\tilde{s}|s_i) \\ &= w(s)w(\tilde{s})[\sin \Delta\psi(s) \cos \Delta\psi(\tilde{s}) - \cos \Delta\psi(s) \sin \Delta\psi(\tilde{s})] \\ &= w(s)w(\tilde{s}) \sin[\Delta\psi(s) - \Delta\psi(\tilde{s})] \end{aligned}$$

Using this and the phase amplitude form of the orbit:

$$\begin{aligned}x_0(s) &= A_i w(s) \cos[\psi(s)] \\ &= \sqrt{\epsilon} w(s) \cos[\Delta\psi(s) + \psi_i]\end{aligned}$$

- ◆ Initial phase ψ_i implicitly chosen (can always do) for initial amplitude $A_i \geq 0$

the orbit deviation from chromatic effects can be calculated as:

$$\begin{aligned}\eta(s) &= n\delta \int_{s_i}^s d\tilde{s} G(s, \tilde{s}) \kappa(\tilde{s}) x_0(\tilde{s}) \\ &= n\delta \sqrt{\epsilon} w(s) \int_{s_i}^s d\tilde{s} w^2(\tilde{s}) \sin[\Delta\psi(s) - \Delta\psi(\tilde{s})] \cos[\Delta\psi(\tilde{s}) + \psi_i]\end{aligned}$$

Formula applicable to all types of focusing lattices:

- ◆ Quadrupole: electric and magnetic
- ◆ Solenoid (Larmor frame)
- ◆ Linac and rings

Add examples in future editions of notes ...

Comments:

- ◆ Perturbative formulas can be derived to calculate the effect on betatron tunes (particle oscillations per lap) in a ring based on integrals of the unperturbed betatron function: see Wiedemann, *Particle Accelerator Physics*
- ◆ For magnetic quadrupole lattices further detailed analysis (see Steffen, *High Energy Beam Optics*) it can be shown that:

- Impossible to make an achromatic focus in any quadrupole system.

Here achromatic means if

$$\eta(s_i) = 0 = \eta'(s_i)$$

there is some achromatic point $s = s_f$ post optics with

$$\eta(s_f) = 0 = \eta'(s_f)$$

- ◆ More detailed analysis of the chromatic correction to particle orbits in rings show that a properly oriented nonlinear sextupole inserted into the periodic ring lattice with correct azimuthal orientation at a large dispersion points can to leading order compensate for chromatic corrections. See Wille, *The Physics of Particle Accelerators* for details.
 - Correction introduces nonlinear terms for large amplitude
 - Correction often distributed around ring for practical reasons

Appendix A: Green Function for Driven Hill's Equation

Following Wiedemann (Particle Accelerator Physics, 1993, pp 106) first, consider more general *Driven Hill's Equation*

$$x'' + \kappa(s)x = p(s)$$

The corresponding homogeneous equation:

$$x'' + \kappa(s)x = 0$$

has principal solutions

$$x(s) = C_1 \mathcal{C}(s|s_i) + C_2 \mathcal{S}(s|s_i) \quad C_1, C_2 = \text{constants}$$

where

Cosine-Like Solution

$$\mathcal{C}'' + \kappa(s)\mathcal{C} = 0$$

$$\mathcal{C}(s = s_i) = 1$$

$$\mathcal{C}'(s = s_i) = 0$$

Sine-Like Solution

$$\mathcal{S}'' + \kappa(s)\mathcal{S} = 0$$

$$\mathcal{S}(s = s_i) = 0$$

$$\mathcal{S}'(s = s_i) = 1$$

Recall that the homogeneous solutions have the Wronskian symmetry:

♦ See **S5C**

$$W(s) = \mathcal{C}(s)\mathcal{S}'(s) - \mathcal{C}'(s)\mathcal{S}(s) = 1 \quad \mathcal{C}(s) \equiv \mathcal{C}(s|s_i) \quad \text{etc.}$$

A **particular solution** to the *Driven Hill's Equation* can be constructed using a **Greens' function method**:

$$x(s) = \int_{s_i}^s d\tilde{s} G(s, \tilde{s})p(\tilde{s})$$

$$G(s, \tilde{s}) = \mathcal{S}(s|s_i)\mathcal{C}(\tilde{s}|s_i) - \mathcal{C}(s|s_i)\mathcal{S}(\tilde{s}|s_i)$$

Demonstrate this works by first taking derivatives:

$$x = \mathcal{S}(s) \int_{s_i}^s d\tilde{s} \mathcal{C}(\tilde{s})p(\tilde{s}) - \mathcal{C}(s) \int_{s_i}^s d\tilde{s} \mathcal{S}(\tilde{s})p(\tilde{s})$$

$$x' = \mathcal{S}'(s) \int_{s_i}^s d\tilde{s} \mathcal{C}(\tilde{s})p(\tilde{s}) - \mathcal{C}'(s) \int_{s_i}^s d\tilde{s} \mathcal{S}(\tilde{s})p(\tilde{s})$$

$$+ p(s) [\cancel{\mathcal{S}(s)\mathcal{C}(s)} - \cancel{\mathcal{S}(s)\mathcal{C}(s)}] \quad [\dots] = 0$$

$$= \mathcal{S}'(s) \int_{s_i}^s d\tilde{s} \mathcal{C}(\tilde{s})p(\tilde{s}) - \mathcal{C}'(s) \int_{s_i}^s d\tilde{s} \mathcal{S}(\tilde{s})p(\tilde{s})$$

$$x'' = \mathcal{S}''(s) \int_{s_i}^s d\tilde{s} \mathcal{C}(\tilde{s})p(\tilde{s}) - \mathcal{C}''(s) \int_{s_i}^s d\tilde{s} \mathcal{S}(\tilde{s})p(\tilde{s})$$

$$+ p(s) [\cancel{\mathcal{S}'(s)\mathcal{C}(s)} - \cancel{\mathcal{C}'(s)\mathcal{S}(s)}] \quad [\dots] = 1 \quad \text{Wronskian Symmetry}$$

$$= p(s) + \mathcal{S}''(s) \int_{s_i}^s d\tilde{s} \mathcal{C}(\tilde{s})p(\tilde{s}) - \mathcal{C}''(s) \int_{s_i}^s d\tilde{s} \mathcal{S}(\tilde{s})p(\tilde{s})$$

Apply these results in the *Driven Hill's Equation*:

Definition of Principal Orbit Functions

$$\begin{aligned}
 x'' + \kappa(s)x &= p(s) + [\cancel{\mathcal{S}''} + \overset{0}{\kappa\mathcal{S}}] \int_{s_i}^s d\tilde{s} \mathcal{C}(\tilde{s})p(\tilde{s}) - [\cancel{\mathcal{C}''} + \overset{0}{\kappa\mathcal{C}}] \int_{s_i}^s d\tilde{s} \mathcal{S}(\tilde{s})p(\tilde{s}) \\
 &= p(s)
 \end{aligned}$$

Thereby proving we have a valid particular solution. The general solution to the *Driven Hill's Equation* is then:

- ◆ Choose constants C_1, C_2 consistent with particle initial conditions at $s = s_i$

$$\begin{aligned}
 x(s) &= x(s_i)\mathcal{C}(s|s_i) + x'(s_i)\mathcal{S}(s|s_i) + \int_{s_i}^s d\tilde{s} G(s, \tilde{s})p(\tilde{s}) \\
 G(s, \tilde{s}) &= \mathcal{S}(s|s_i)\mathcal{C}(\tilde{s}|s_i) - \mathcal{C}(s|s_i)\mathcal{S}(\tilde{s}|s_i)
 \end{aligned}$$

Appendix B: Uniqueness of the Dispersion Function in a Periodic (Ring) Lattice

Consider the equation for the dispersion function in a periodic lattice

$$D'' + \kappa_x D = \frac{1}{R} \quad \begin{array}{l} \kappa_x(s + L_p) = \kappa_x(s) \\ R(s + L_p) = R(s) \end{array}$$

It is required that the solution for a periodic (ring) lattice has the periodicity of the lattice:

$$D(s + L_p) = D(s)$$

Assume that there are two unique solutions to D and label them as D_j . Each must satisfy:

$$D_j'' + \kappa_x D_j = \frac{1}{R} \quad D_j(s + L_p) = D_j(s) \quad j = 1, 2$$

Subtracting the two equations shows that $D_1 - D_2$ satisfies Hill's equation:

$$(D_1 - D_2)'' + \kappa_x (D_1 - D_2) = 0$$

The solution can be expressed in terms of the usual principal orbit functions of Hill's Equation in matrix form as:

$$\begin{bmatrix} D_1 - D_2 \\ (D_1 - D_2)' \end{bmatrix}_s = \begin{bmatrix} C(s|s_i) & S(s|s_i) \\ C'(s|s_i) & S'(s|s_i) \end{bmatrix} \cdot \begin{bmatrix} D_1 - D_2 \\ (D_1 - D_2)' \end{bmatrix}_{s_i}$$

Because C and S do not, in general, have the periodicity of the lattice, we must have:

$$D_1(s_i) = D_2(s_i)$$

$$D_1'(s_i) = D_2'(s_i)$$

which implies a zero solution for $D_1 - D_2$ and:

$$D_1(s) = D_2(s) \implies D \text{ is unique for a periodic lattice}$$

The proof fails for $\sigma_{0x}/(2\pi = \text{integer})$, however, this exceptional case should never correspond to a lattice choice because it would result in unstable particle orbits.

An alternative proof based on the eigenvalue structure of the 3x3 transfer matrices for D can be found in "Accelerator Physics" by SY Lee.

◆ Proof helps further clarify the structure of D

Appendix C: Transfer Matrix of a Negative Bend

Input from C.Y. Wong, MSU

For a clockwise bend (derived in the problem set):

$$\begin{pmatrix} D \\ D' \\ 1 \end{pmatrix}_f = \mathbf{M}_B \begin{pmatrix} D \\ D' \\ 1 \end{pmatrix}_i$$

$$\mathbf{M}_B = \begin{pmatrix} \cos \theta & \rho \sin \theta & \rho(1 - \cos \theta) \\ -\frac{\sin \theta}{\rho} & \cos \theta & \sin \theta \\ 0 & 0 & 1 \end{pmatrix} \quad \begin{matrix} \rho > 0 \\ \theta > 0 \end{matrix}$$

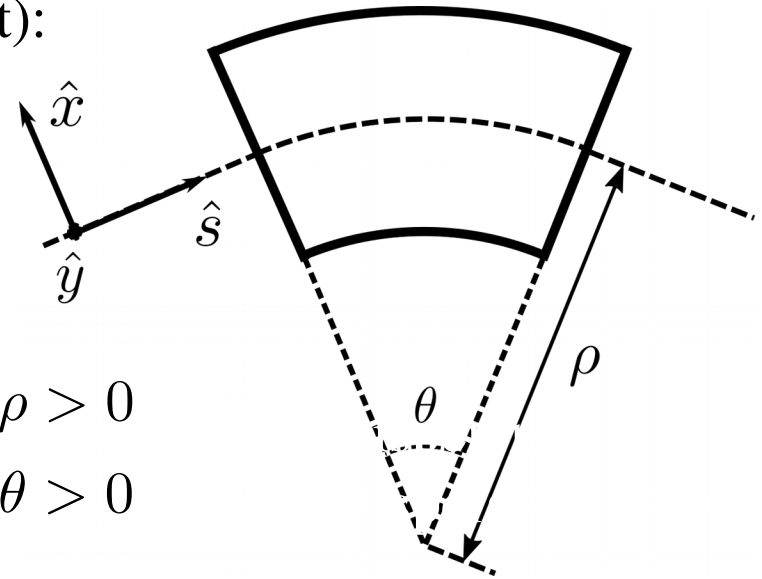

This definition of the x,y,s coordinates is right-handed

The transfer matrix for a negative (anti-clockwise) bend is obtained by making the transformation $\rho \rightarrow -\rho$, $\theta \rightarrow -\theta$

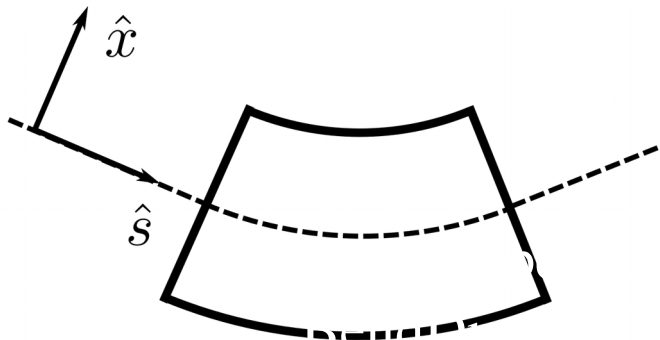

$$\mathbf{M}_{-B} = \begin{pmatrix} \cos |\theta| & |\rho| \sin |\theta| & -|\rho| (1 - \cos |\theta|) \\ -\frac{\sin |\theta|}{|\rho|} & \cos |\theta| & -\sin |\theta| \\ 0 & 0 & 1 \end{pmatrix}$$

If one finds the result counterintuitive, it can be derived as follows:

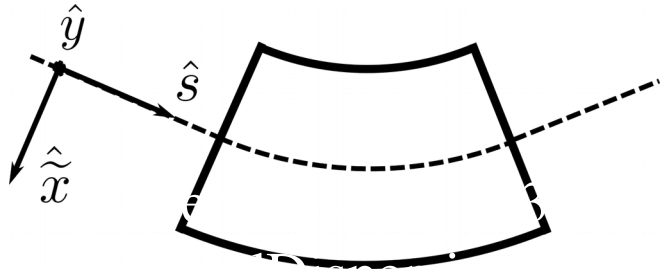

Define $\tilde{x} = -x$

(The new set of coordinates is not right-handed, but this does not affect the reasoning)

The dispersion functions in the two coordinate systems are related by

$$\begin{pmatrix} \tilde{D} \\ \tilde{D}' \\ 1 \end{pmatrix} = \mathbf{R} \begin{pmatrix} D \\ D \\ 1 \end{pmatrix} \quad \text{where} \quad \mathbf{R} = \mathbf{R}^{-1} = \begin{pmatrix} -1 & 0 & 0 \\ 0 & -1 & 0 \\ 0 & 0 & 1 \end{pmatrix}$$

The anti-clockwise bend is effectively clockwise in the primed coordinate system:

$$\begin{pmatrix} \tilde{D} \\ \tilde{D}' \\ 1 \end{pmatrix}_f = \mathbf{M}_B \begin{pmatrix} \tilde{D} \\ \tilde{D}' \\ 1 \end{pmatrix}_i \quad \Longrightarrow \quad \mathbf{R} \begin{pmatrix} D \\ D' \\ 1 \end{pmatrix}_f = \mathbf{M}_B \mathbf{R} \begin{pmatrix} D \\ D' \\ 1 \end{pmatrix}_i$$

Transfer matrix of anti-clockwise bend in normal coordinates:

$$\mathbf{M}_{-B} = \mathbf{R}^{-1} \mathbf{M}_B \mathbf{R} = \begin{pmatrix} \cos |\theta| & |\rho| \sin |\theta| & -|\rho| (1 - \cos |\theta|) \\ -\frac{\sin |\theta|}{|\rho|} & \cos |\theta| & -\sin |\theta| \\ 0 & 0 & 1 \end{pmatrix}$$

S10: Acceleration and Normalized Emittance

S10A: Introduction

If the beam is **accelerated** longitudinally in a linear focusing channel, the x -particle equation of motion (see: **S1** and **S2**) is:

$$x'' + \frac{(\gamma_b \beta_b)'}{(\gamma_b \beta_b)} x' + \kappa_x x = - \frac{q}{m \gamma_b^3 \beta_b^2 c^2} \frac{\partial \phi}{\partial x}$$

Analogous equation holds in y

Neglects:

- ◆ Nonlinear applied focusing fields
- ◆ Momentum spread effects

Comments:

- ◆ γ_b , β_b are regarded as **prescribed functions** of s set by the **acceleration schedule** of the machine
- ◆ Variations in γ_b , β_b due to acceleration must be included in and/or compensated by adjusting the strength of the optics via optical parameters contained in κ_x , κ_y
 - Example: for quadrupole focusing adjust field gradients (see: **S2**)

Acceleration Factor: Characteristics of Relativistic Factor

$$\gamma_b \beta_b \simeq \begin{cases} \gamma_b, & \text{Relativistic Limit} \\ \beta_b, & \text{Nonrelativistic Limit} \end{cases}$$

$$\gamma_b \equiv \frac{1}{\sqrt{1 - \beta_b^2}}$$

Beam/Particle Kinetic Energy:

$$\mathcal{E}_b(s) = (\gamma_b - 1)mc^2 = \text{Beam Kinetic Energy}$$

- ◆ Function of s specified by Acceleration schedule for transverse dynamics
- ◆ See **S11** for calculation of \mathcal{E}_b and $\gamma_b \beta_b$ from longitudinal dynamics and J.J. Barnard lectures on **Longitudinal Dynamics**

Approximate energy gain from average gradient:

$$\mathcal{E}_b \simeq \mathcal{E}_i + G(s - s_i)$$

$\mathcal{E}_i = \text{const} = \text{Initial Energy}$

$G = \text{const} = \text{Average Gradient}$

- ◆ Real energy gain will be rapid when going through discreet acceleration gaps

$$\mathcal{E}_b \simeq \begin{cases} \gamma_b mc^2, & \text{Relativistic Limit, } \gamma_b \gg 1 \\ \frac{1}{2} m \beta_b^2 c^2, & \text{Nonrelativistic Limit, } |\beta_b| \ll 1 \end{cases}$$

Comments Continued:

- ◆ In typical accelerating systems, changes in $\gamma_b\beta_b$ are slow and the fractional changes in the orbit induced by acceleration are small
 - Exception near an injector since the beam is often not yet energetic
- ◆ The acceleration term:

$$\frac{(\gamma_b\beta_b)'}{(\gamma_b\beta_b)} > 0$$

will act to damp particle oscillations (see following slides for motivation)

Even with acceleration, we will find that there is a Courant-Snyder invariant (normalized emittance) that is valid in an analogous context as in the case without acceleration provided phase-space coordinates are chosen to compensate for the damping of particle oscillations

Identify relativistic factor with average gradient energy gain:

Relativistic Limit: $\gamma_b \gg 1$

$$\gamma_b \simeq \frac{\mathcal{E}_b}{mc^2} = \frac{\mathcal{E}_i}{mc^2} + \frac{G}{mc^2}(s - s_i)$$

$$\implies \frac{(\gamma_b \beta_b)'}{(\gamma_b \beta_b)} \simeq \frac{\gamma_b'}{\gamma_b} \simeq \frac{1}{\frac{\mathcal{E}_i}{G} + (s - s_i)} \sim \frac{1}{s - s_i}$$

Nonrelativistic Limit: $|\beta_b| \ll 1$

$$\beta_b \simeq \sqrt{2 \frac{\mathcal{E}_b}{mc^2}} = \sqrt{2 \frac{\mathcal{E}_i}{mc^2} + 2 \frac{G}{mc^2}(s - s_i)}$$

$$\implies \frac{(\gamma_b \beta_b)'}{(\gamma_b \beta_b)} \simeq \frac{\beta_b'}{\beta_b} = \frac{1/2}{\frac{\mathcal{E}_i}{G} + (s - s_i)} \sim \frac{1}{2(s - s_i)}$$

- ◆ Expect **Relativistic** and **Nonrelativistic** motion to have similar solutions
 - Parameters for each case will often be quite different

/// Aside: **Acceleration and Continuous Focusing Orbits** with $\kappa_x = k_{\beta 0}^2 = \text{const}$
 Assume relativistic motion and negligible space-charge:

$$\frac{(\gamma_b \beta_b)'}{(\gamma_b \beta_b)} \simeq \frac{\gamma_b'}{\gamma_b} = \frac{1}{\left(\frac{\mathcal{E}_i}{G} - s_i\right) + s} \quad \frac{\partial \phi}{\partial x} \simeq 0$$

Then the equation of motion reduces to:

$$x'' + \frac{1}{\left(\frac{\mathcal{E}_i}{G} - s_i\right) + s} x' + k_{\beta 0}^2 x = 0$$

This equation is the equation of a Bessel Function of order zero:

$$\frac{d^2 x}{d\xi^2} + \frac{1}{\xi} \frac{dx}{d\xi} + x = 0 \quad \begin{aligned} \xi &= k_{\beta 0} s + k_{\beta 0} \left(\frac{\mathcal{E}_i}{G} - s_i\right) \\ \xi' &= k_{\beta 0} \end{aligned}$$

$$\begin{aligned} x &= C_1 J_0(\xi) + C_2 Y_0(\xi) & C_1 = \text{const} \quad C_2 = \text{const} \\ x' &= -C_1 k_{\beta 0} J_1(\xi) - C_2 k_{\beta 0} Y_1(\xi) & J_n = \text{Order } n \text{ Bessel Func (1st kind)} \\ & & Y_n = \text{Order } n \text{ Bessel Func (2nd kind)} \\ & & dJ_0(x)/dx = -J_1(x) \text{ and same for } Y_0 \end{aligned}$$

Solving for the constants in terms of the particle initial conditions:

$$\begin{bmatrix} x_i \\ x'_i \end{bmatrix} = \begin{bmatrix} J_0(\xi_i) & Y_0(\xi_i) \\ -k_{\beta 0} J_1(\xi_i) & -k_{\beta 0} Y_1(\xi_i) \end{bmatrix} \cdot \begin{bmatrix} C_1 \\ C_2 \end{bmatrix}$$

$$\begin{aligned} x_i &\equiv x(s = s_i) & \xi_i &\equiv k_{\beta 0} \frac{\mathcal{E}_i}{G} = \xi(s = s_i) \\ x'_i &\equiv x'(s = s_i) \end{aligned}$$

Invert matrix to solve for constants in terms of initial conditions:

$$\implies \begin{bmatrix} C_1 \\ C_2 \end{bmatrix} = \frac{1}{\Delta} \begin{bmatrix} -k_{\beta 0} Y_1(\xi_i) & -Y_0(\xi_i) \\ k_{\beta 0} J_1(\xi_i) & J_0(\xi_i) \end{bmatrix} \cdot \begin{bmatrix} x_i \\ x'_i \end{bmatrix}$$

$$\Delta \equiv k_{\beta 0} [Y_0(\xi_i) J_1(\xi_i) - J_0(\xi_i) Y_1(\xi_i)]$$

Comments:

- ♦ Bessel functions behave like damped harmonic oscillators
 - See texts on Mathematical Physics or Applied Mathematics
- ♦ Nonrelativistic limit solution is *not* described by a Bessel Function solution
 - Properties of solution will be similar though (similar special function)
 - The coefficient in the damping term $\propto x'$ has a factor of 2 difference, preventing exact Bessel function form

Using this solution, plot the orbit for (contrived parameters for illustration only):

$$k_{\beta 0} = \frac{\sigma_0}{L_p}$$

$$\sigma_0 = 90^\circ / \text{Period}$$

$$\mathcal{E}_i = 1000 \text{ MeV}$$

$$L_p = 0.5 \text{ m}$$

$$G = 100 \text{ MeV/m}$$

$$x(0) = 10 \text{ mm}$$

$$s_i = 0$$

$$x'(0) = 0 \text{ mrad}$$

$$\frac{\gamma_{bi}}{\gamma_b} = \frac{1}{1 + (G/\mathcal{E}_i)(s - s_i)}$$

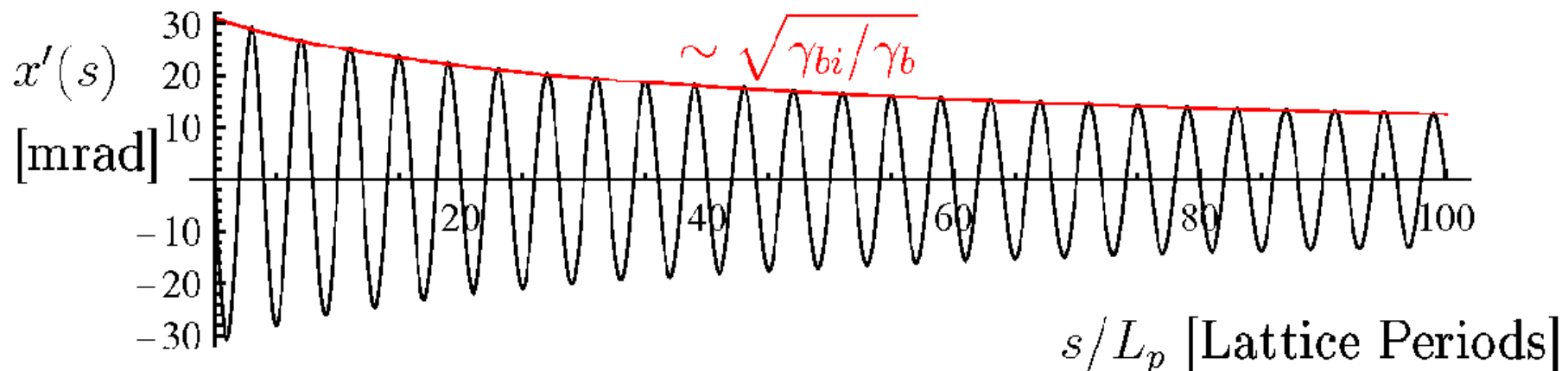
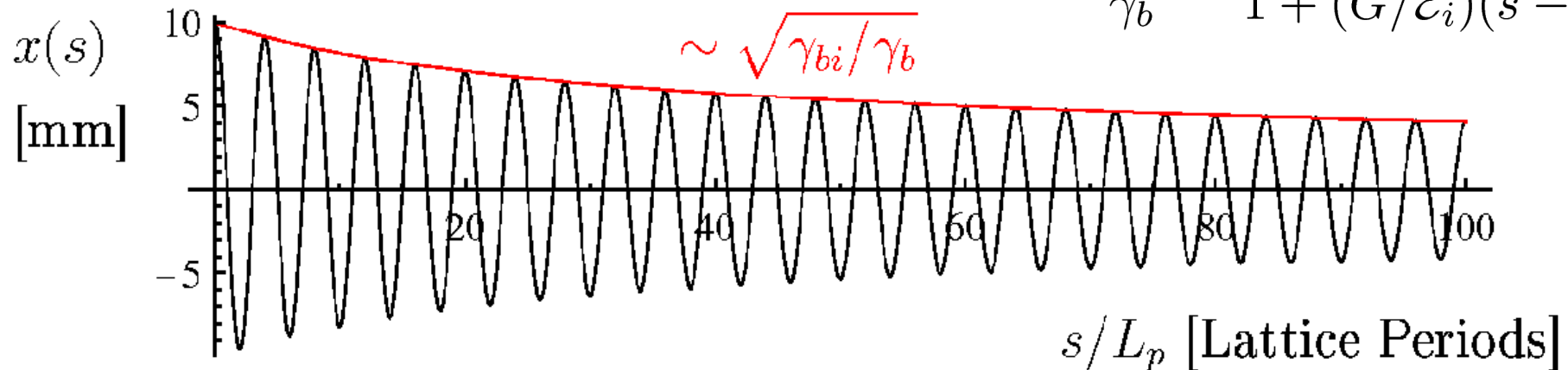

◆ Solution shows damping: phase volume scaling $\sim 1/(\gamma_b \beta_b) \simeq 1/\gamma_b$ ///

S10B: Transformation to Normal Form

“Guess” transformation to apply motivated by conjugate variable arguments
(see: J.J. Barnard, **Intro. Lectures**)

$$\tilde{x} \equiv \sqrt{\gamma_b \beta_b} x$$

Then:

Here we reuse tilde variables to denote a transformed quantity we choose to look like something familiar from simpler contexts

$$x = \frac{1}{\sqrt{\gamma_b \beta_b}} \tilde{x}$$

$$x' = \frac{1}{\sqrt{\gamma_b \beta_b}} \tilde{x}' - \frac{1}{2} \frac{(\gamma_b \beta_b)'}{(\gamma_b \beta_b)^{3/2}} \tilde{x}$$

$$x'' = \frac{1}{\sqrt{\gamma_b \beta_b}} \tilde{x}'' - \frac{(\gamma_b \beta_b)'}{(\gamma_b \beta_b)^{3/2}} \tilde{x}' + \left[\frac{3}{4} \frac{(\gamma_b \beta_b)'^2}{(\gamma_b \beta_b)^{5/2}} - \frac{1}{2} \frac{(\gamma_b \beta_b)''}{(\gamma_b \beta_b)^{3/2}} \right] \tilde{x}$$

The inverse phase-space transforms will also be useful later:

$$\tilde{x} = \sqrt{\gamma_b \beta_b} x$$

$$\tilde{x}' = \sqrt{\gamma_b \beta_b} x' + \frac{1}{2} \frac{(\gamma_b \beta_b)'}{\sqrt{\gamma_b \beta_b}} x$$

Applying these results, the particle x - **equation of motion with acceleration** becomes:

$$\tilde{x}'' + \left[\kappa_x + \frac{1}{4} \frac{(\gamma_b \beta_b)'^2}{(\gamma_b \beta_b)^2} - \frac{1}{2} \frac{(\gamma_b \beta_b)''}{(\gamma_b \beta_b)} \right] \tilde{x} = - \frac{q}{m \gamma_b^2 \beta_b c^2} \frac{\partial \phi}{\partial \tilde{x}}$$

Note:

- ◆ Factor of $\gamma_b \beta_b$ difference from untransformed expression in the space-charge coupling coefficient

It is instructive to also transform the **Possion equation** associated with the space-charge term:

$$\left(\frac{\partial^2}{\partial x^2} + \frac{\partial^2}{\partial y^2} \right) \phi = - \frac{\rho}{\epsilon_0}$$

Transform:

$$\frac{\partial^2}{\partial x^2} = \left(\frac{\partial \tilde{x}}{\partial x} \frac{\partial}{\partial \tilde{x}} \right) \left(\frac{\partial \tilde{x}}{\partial x} \frac{\partial}{\partial \tilde{x}} \right) = \gamma_b \beta_b \frac{\partial^2}{\partial \tilde{x}^2}$$

$$\frac{\partial^2}{\partial y^2} = \left(\frac{\partial \tilde{y}}{\partial y} \frac{\partial}{\partial \tilde{y}} \right) \left(\frac{\partial \tilde{y}}{\partial y} \frac{\partial}{\partial \tilde{y}} \right) = \gamma_b \beta_b \frac{\partial^2}{\partial \tilde{y}^2}$$

Using these results, Poisson's equation becomes:

$$\left(\frac{\partial^2}{\partial \tilde{x}^2} + \frac{\partial^2}{\partial \tilde{y}^2} \right) \phi = -\frac{\rho}{\gamma_b \beta_b \epsilon_0}$$

Or defining a **transformed potential** $\tilde{\phi}$

$$\tilde{\phi} = \gamma_b \beta_b \phi$$

$$\left(\frac{\partial^2}{\partial \tilde{x}^2} + \frac{\partial^2}{\partial \tilde{y}^2} \right) \tilde{\phi} = -\frac{\rho}{\epsilon_0}$$

Applying these results, the x -**equation of motion with acceleration** becomes:

$$\tilde{x}'' + \left[\kappa_x + \frac{1}{4} \frac{(\gamma_b \beta_b)'^2}{(\gamma_b \beta_b)^2} - \frac{1}{2} \frac{(\gamma_b \beta_b)''}{(\gamma_b \beta_b)} \right] \tilde{x} = -\frac{q}{m \gamma_b^3 \beta_b^2 c^2} \frac{\partial \tilde{\phi}}{\partial \tilde{x}}$$

- Usual form of the space-charge coefficient with $\gamma_b^3 \beta_b^2$ rather than $\tilde{\gamma}_b^2 \beta_b$ is restored when expressed in terms of the transformed potential $\tilde{\phi}$

An additional step can be taken to further stress the correspondence between the transformed system with acceleration and the untransformed system in the absence of acceleration.

Denote an **effective focusing strength**:

$$\tilde{\kappa}_x \equiv \kappa_x + \frac{1}{4} \frac{(\gamma_b \beta_b)'^2}{(\gamma_b \beta_b)^2} - \frac{1}{2} \frac{(\gamma_b \beta_b)''}{(\gamma_b \beta_b)}$$

$\tilde{\kappa}_x$ incorporates acceleration terms beyond γ_b , β_b factors already included in the definition of κ_x (see: **S2**):

$$\kappa_x = \begin{cases} \frac{qG}{m\gamma_b\beta_b^2c^2}, & G = -\partial E_x^a/\partial x = \partial E_y^a/\partial y = \text{Electric Quad. Grad.} \\ \frac{qG}{m\gamma_b\beta_b c}, & G = \partial B_x^a/\partial y = \partial B_y^a/\partial x = \text{Magnetic Quad. Grad.} \\ \frac{qB_{z0}}{4m\gamma_b^2\beta_b^2c^2}, & B_{z0} = \text{Solenoidal Magnetic Field} \end{cases}$$

The **transformed equation of motion with acceleration** then becomes:

$$\tilde{x}'' + \tilde{\kappa}_x \tilde{x} = -\frac{q}{m\gamma_b^3\beta_b^2c^2} \frac{\partial \tilde{\phi}}{\partial \tilde{x}}$$

The transformed equation **with acceleration** has the same form as the equation in the **absence of acceleration**. If space-charge is negligible ($\partial\phi/\partial\mathbf{x}_\perp \simeq 0$) we have:

Accelerating System

Non-Accelerating System

$$\tilde{x}'' + \tilde{\kappa}_x \tilde{x} = 0 \quad \Longrightarrow \quad x'' + \kappa_x x = 0$$

Therefore, *all previous analysis* on **phase-amplitude methods** and **Courant-Snyder invariants** associated with Hill's equation in x - x' phase-space can be immediately applied to $\tilde{x} - \tilde{x}'$ phase-space for an **accelerating beam**

$$\left(\frac{\tilde{x}}{\tilde{w}_x} \right)^2 + (\tilde{w}_x \tilde{x}' - \tilde{w}_x' \tilde{x})^2 = \tilde{\epsilon} = \text{const}$$

$$\tilde{w}_x'' + \tilde{\kappa}_x \tilde{w}_x - \frac{1}{\tilde{w}_x^3} = 0$$

$$\tilde{w}_x(s + L_p) = \tilde{w}_x(s)$$

$$\pi \tilde{\epsilon} = \text{Area traced by orbit} = \text{const}$$

in \tilde{x} - \tilde{x}' phase-space

- ◆ Focusing field strengths need to be adjusted to maintain periodicity of $\tilde{\kappa}_x$ in the presence of acceleration
 - Not possible to do exactly, but can be approximate for weak acceleration

S10C: Phase Space Relation Between Transformed and UnTransformed Systems

It is instructive to relate the transformed phase-space area in tilde variables to the usual x - x' phase area:

$$d\tilde{x} \otimes d\tilde{x}' = |J| dx \otimes dx'$$

where J is the Jacobian:

$$\begin{aligned} J &\equiv \det \begin{bmatrix} \frac{\partial \tilde{x}}{\partial x} & \frac{\partial \tilde{x}}{\partial x'} \\ \frac{\partial \tilde{x}'}{\partial x} & \frac{\partial \tilde{x}'}{\partial x'} \end{bmatrix} \\ &= \det \begin{bmatrix} \sqrt{\gamma_b \beta_b} & 0 \\ \frac{1}{2} \frac{(\gamma_b \beta_b)'}{\sqrt{\gamma_b \beta_b}} & \sqrt{\gamma_b \beta_b} \end{bmatrix} = \gamma_b \beta_b \end{aligned}$$

Inverse transforms derived in S10B:

$$\begin{aligned} \tilde{x} &= \sqrt{\gamma_b \beta_b} x \\ \tilde{x}' &= \sqrt{\gamma_b \beta_b} x' + \frac{1}{2} \frac{(\gamma_b \beta_b)'}{\sqrt{\gamma_b \beta_b}} x \end{aligned}$$

Thus:

$$d\tilde{x} \otimes d\tilde{x}' = \gamma_b \beta_b dx \otimes dx'$$

Based on this area transform, if we define the (instantaneous) phase space area of the orbit trace in $x-x'$ to be $\pi\epsilon_x$ “regular emittance”, then this emittance is related to the “normalized emittance” $\tilde{\epsilon}_x$ in $\tilde{x} - \tilde{x}'$ phase-space by:

$$\begin{aligned}\tilde{\epsilon}_x &= \gamma_b \beta_b \epsilon_x \\ &\equiv \text{Normalized Emittance} \equiv \epsilon_{nx}\end{aligned}$$

- ◆ Factor $\gamma_b \beta_b$ compensates for acceleration induced damping in particle orbits
- ◆ Normalized emittance is very important in design of lattices to transport accelerating beams
 - Designs usually made assuming conservation of normalized emittance
- ◆ Same result that J.J. Barnard motivated in the **Intro. Lectures** using alternative methods

S11: Calculation of Acceleration Induced Changes in gamma and beta

S11A: Introduction

The **transverse particle equation of motion** with **acceleration** was derived in a Cartesian system by approximating (see: **S1**):

$$\frac{d}{dt} \left(m\gamma \frac{d\mathbf{x}_{\perp}}{dt} \right) \simeq q\mathbf{E}_{\perp}^a + q\beta_b c \hat{\mathbf{z}} \times \mathbf{B}_{\perp}^a + qB_z^a \mathbf{v}_{\perp} \times \hat{\mathbf{z}} - q \frac{1}{\gamma_b^2} \frac{\partial \phi}{\mathbf{x}_{\perp}}$$

using

$$m \frac{d}{dt} \left(\gamma \frac{d\mathbf{x}_{\perp}}{dt} \right) \simeq m\gamma_b \beta_b^2 c^2 \left[\mathbf{x}_{\perp}'' + \frac{(\gamma_b \beta_b)'}{(\gamma_b \beta_b)} \mathbf{x}_{\perp}' \right]$$

to obtain:

$$\mathbf{x}_{\perp}'' + \frac{(\gamma_b \beta_b)'}{(\gamma_b \beta_b)} \mathbf{x}_{\perp}' = \frac{q}{m\gamma_b \beta_b^2 c^2} \mathbf{E}_{\perp}^a + \frac{q}{m\gamma_b \beta_b c} \hat{\mathbf{z}} \times \mathbf{B}_{\perp}^a + \frac{qB_z^a}{m\gamma_b \beta_b c} \mathbf{x}_{\perp}' \times \hat{\mathbf{z}} - \frac{q}{\gamma_b^3 \beta_b^2 c^2} \frac{\partial}{\partial \mathbf{x}_{\perp}} \phi$$

To integrate this equation, we need the variation of β_b and $\gamma_b = 1/\sqrt{1 - \beta_b^2}$ as a function of s . For completeness here, we briefly outline how this can be done by analyzing longitudinal equations of motion. More details can be found in JJ Barnard lectures on **Longitudinal Dynamics**.

S11B: Solution of Longitudinal Equation of Motion

Changes in $\gamma_b\beta_b$ are calculated from the **longitudinal particle equation of motion**:

♦ See equation at end of **S1D**

$$\frac{d}{dt} \left(m\gamma \frac{dz}{dt} \right) \simeq \underbrace{qE_z^a}_{\text{Term 1}} - \underbrace{q(v_x B_y^a - v_y B_x^a)}_{\text{Term 3}} - \underbrace{q \frac{\partial \phi}{\partial z}}_{\text{Neglect Rel to Term 2}}$$

Using steps similar to those in **S1**, we approximate terms:

$$\begin{aligned} \text{Term 1:} \quad \frac{d}{dt} \left(\gamma \frac{dz}{dt} \right) &\simeq c^2 \beta_b (\gamma_b \beta_b)' & \frac{dz}{dt} = v_z &\simeq \beta_b c & \gamma &\simeq \gamma_b \\ \text{Term 2:} \quad \frac{q}{m} E_z^a &\simeq - \frac{q}{m} \frac{\partial \phi^a}{\partial s} \Big|_{x=y=0} & \frac{d}{dt} &\simeq \beta_b c \frac{d}{ds} \end{aligned}$$

ϕ^a is a quasi-static approximation accelerating potential (see next pages)

$$\text{Term 3:} \quad -q(v_x B_y^a - v_y B_x^a) = -q \left(\frac{dx}{dt} B_y^a - \frac{dy}{dt} B_x^a \right) \simeq 0$$

♦ Transverse magnetic fields typically only weakly change particle energy and terms can be neglected relative to others

The longitudinal particle equation of motion for γ_b , β_b then reduces to:

$$\beta_b(\gamma_b\beta_b)' \simeq - \frac{q}{mc^2} \frac{\partial\phi^a}{\partial s} \Big|_{x=y=0}$$

Some algebra shows:

$$\gamma_b' = \left(\frac{1}{\sqrt{1-\beta_b^2}} \right)' = \frac{\beta_b\beta_b'}{(1-\beta_b^2)^{3/2}} = \gamma_b^3\beta_b\beta_b'$$

First apply chain rule, then use the result above twice to simplify results:

$$\begin{aligned} \implies \beta_b(\gamma_b\beta_b)' &= \beta_b^2\gamma_b' + \gamma_b\beta_b\beta_b' \\ &= (1 + \gamma_b^2\beta_b^2)\gamma_b\beta_b\beta_b' = \gamma_b^3\beta_b\beta_b' \\ &= \gamma_b' \end{aligned}$$

Giving:

$$\gamma_b' = - \frac{q}{mc^2} \frac{\partial\phi^a}{\partial s} \Big|_{x=y=0}$$

Which can then be integrated to obtain:

$$\gamma_b = - \frac{q}{mc^2} \phi^a(r=0, z=s) + \text{const}$$

We denote the on-axis accelerating potential as:

$$V(s) \equiv \phi^a(x = y = 0, z = s)$$

• Can represent RF or induction accelerating gap fields

See: J.J. Barnard lectures for more details

Using this and setting $\gamma_b(s = s_i) = \gamma_{bi}$ gives for the gain in axial kinetic energy \mathcal{E}_b and corresponding changes in γ_b, β_b factors:

$$\mathcal{E}_b = (\gamma_b - 1)mc^2 = q[V(s_i) - V(s)] + \mathcal{E}_{bi}$$

$$\gamma_b = 1 + \mathcal{E}_{bi}/(mc^2)$$

$$\mathcal{E}_{bi} = (\gamma_{bi} - 1)mc^2$$

$$\beta_b = \sqrt{1 - 1/\gamma_b^2}$$

These equations can be solved for the consistent variation of $\gamma_b(s), \beta_b(s)$ to integrate the **transverse equations of motion**:

$$\mathbf{x}_{\perp}'' + \frac{(\gamma_b \beta_b)'}{(\gamma_b \beta_b)} \mathbf{x}_{\perp}' = \frac{q}{m \gamma_b \beta_b^2 c^2} \mathbf{E}_{\perp}^a + \frac{q}{m \gamma_b \beta_b c} \hat{\mathbf{z}} \times \mathbf{B}_{\perp}^a + \frac{q B_z^a}{m \gamma_b \beta_b c} \mathbf{x}_{\perp}' \times \hat{\mathbf{z}} - \frac{q}{\gamma_b^3 \beta_b^2 c^2} \frac{\partial}{\partial \mathbf{x}_{\perp}} \phi$$

Nonrelativistic limit results

In the **nonrelativistic** limit:

$$\gamma_b \simeq 1 + \frac{1}{2}\beta_b^2 \quad \beta_b^2 \ll 1 \quad \mathcal{E}_b = (\gamma_b - 1)mc^2 \simeq \frac{1}{2}m\beta_b^2 c^2$$

and the previous (relativistic valid) energy gain formulas reduce to:

$$\begin{aligned} \mathcal{E}_b &\simeq \frac{1}{2}m\beta_b^2 c^2 = q[V(s_i) - V(s)] + \mathcal{E}_{bi} \\ \gamma_b &\simeq 1 & \mathcal{E}_{bi} &= \frac{1}{2}m\beta_b^2 c^2 \\ \beta_b &= \sqrt{\frac{2\mathcal{E}_b}{mc^2}} \end{aligned}$$

Using this result, in the nonrelativistic limit we can take in the transverse particle equation of motion:

$$\frac{(\gamma_b \beta_b)'}{(\gamma_b \beta_b)} \simeq \frac{\beta_b'}{\beta_b} = \frac{1}{2} \frac{\mathcal{E}_b'}{\mathcal{E}_b} = -\frac{1}{2} \frac{qV'(s)}{q[V(s_i) - V(s)] + \mathcal{E}_{bi}}$$

Ultra-relativistic limit results

In the **ultra-relativistic** limit:

$$\beta_b \simeq 1 \quad \mathcal{E}_b = (\gamma_b - 1)mc^2 \simeq \gamma_b mc^2$$

and the previous (relativistic valid) energy gain formulas reduce to:

$$\mathcal{E}_b \simeq \gamma_b mc^2 = q[V(s_i) - V(s)] + \mathcal{E}_{bi}$$
$$\beta_b \simeq 1$$

Using this result, in the ultra-relativistic limit we can take in the transverse particle equation of motion:

$$\frac{(\gamma_b \beta_b)'}{(\gamma_b \beta_b)} \simeq \frac{\gamma_b'}{\gamma_b} = \frac{\mathcal{E}_b'}{\mathcal{E}_b} = - \frac{qV'(s)}{q[V(s_i) - V(s)] + \mathcal{E}_{bi}}$$

- ♦ Same form as NR limit expression with only a factor of 1/2 difference; see also **S10A**

S11C: Longitudinal Solution via Energy Gain

An alternative analysis of the particle energy gain carried out in S11B can be illuminating. In this case we start from the exact Lorentz force equation with time as the independent variable for a particle moving in the full electromagnetic field:

$$\frac{d\mathbf{p}}{dt} = q\mathbf{E} + q\vec{\beta}c \times \mathbf{B}$$

$$\mathbf{p} \equiv \gamma m \vec{\beta} c$$

$$\gamma \equiv 1 / \sqrt{1 - \vec{\beta} \cdot \vec{\beta}}$$

Comments:

- ◆ Formulation exact in context of classical electrodynamics
- ◆ γ , $\vec{\beta}$ not expanded
- ◆ \mathbf{E} , \mathbf{B} electromagnetic

Dotting $mc\vec{\beta}$ into this equation:

$$mc\vec{\beta} \cdot \frac{d}{dt}(c\gamma\vec{\beta}) = qc\vec{\beta} \cdot \mathbf{E} + qc\vec{\beta} \cdot [c\vec{\beta} \times \mathbf{B}]$$

$$\begin{matrix} [1] & [2] \\ \left[\vec{\beta} \cdot \vec{\beta} \dot{\gamma} \right] & + \left[\gamma \vec{\beta} \cdot \dot{\vec{\beta}} \right] = \frac{q}{mc} \vec{\beta} \cdot \mathbf{E} \end{matrix}$$

Then

$$\gamma \equiv (1 - \vec{\beta} \cdot \vec{\beta})^{-1/2}$$

Gives:

$$[1]: \left[\vec{\beta} \cdot \vec{\beta} \right] = 1 - 1/\gamma^2 \qquad [2]: \left[\vec{\beta} \cdot \dot{\vec{\beta}} \right] = \dot{\gamma}/\gamma^3$$

Inserting these factors:

$$(1 - 1/\gamma^2)\dot{\gamma} + \dot{\gamma}/\gamma^2 = \frac{q}{mc^2}\vec{\beta} \cdot \mathbf{E}$$

or:

$$\dot{\gamma} = \frac{q}{mc}\vec{\beta} \cdot \mathbf{E}$$

Equivalently:

$$\frac{d}{dt}\mathcal{E} = \frac{d}{dt} [(\gamma - 1)mc^2] = qc\vec{\beta} \cdot \mathbf{E}$$

- ◆ Only the electric field changes the kinetic energy of a particle
- ◆ No approximations made to this point within the context of classical electrodynamics: valid for evolving \mathbf{E} , \mathbf{B} consistent with the Maxwell equations.

Now approximating to our slowly varying and paraxial formulation:

$$\frac{d}{dt} = c\beta_z \frac{d}{ds} \quad \beta_z \simeq \beta \simeq \beta_b \quad \gamma \simeq \gamma_b \quad \mathcal{E} \simeq \mathcal{E}_b = (\gamma_b - 1)mc^2$$

and approximating the axial electric field by the applied component then obtains

$$\frac{d}{ds}\mathcal{E}_b \simeq \frac{dt}{ds} \frac{d}{dt} [(\gamma - 1)mc^2] \simeq qE_z^a$$

which is the longitudinal equation of motion analyzed in [S11B](#).

S11D: Quasistatic Potential Expansion

In the quasistatic approximation, the accelerating potential can be expanded in the axisymmetric limit as:

- ♦ See: J.J. Barnard, **Intro Lectures**; and Reiser, *Theory and Design of Charged Particle Beams*, (1994, 2008) Sec. 3.3.
- ♦ See also: **S2, Appendix D**

We take:

$$\mathbf{E}^a = -\frac{\phi^a}{\partial \mathbf{x}}$$

and apply the results of **S2, Appendix D** to expand ϕ^a in terms of the on-axis potential

$$\phi^a(r, z) = \sum_{\nu=0}^{\infty} \frac{(-1)^\nu}{(\nu!)^2} \frac{\partial^{2\nu} \phi^a(r=0, z)}{\partial z^{2\nu}} \left(\frac{r}{2}\right)^{2\nu}$$

Denote for the on-axis potential

$$\phi^a(r=0, z) \equiv V(z)$$

$$\implies \phi^a = V(z) - \frac{1}{4} \frac{\partial^2}{\partial z^2} V(z) (x^2 + y^2) + \frac{1}{64} \frac{\partial^4}{\partial z^4} V(z) (x^2 + y^2)^2 + \dots$$

The longitudinal acceleration also result in a transverse focusing field

$$\mathbf{E}_{\perp}^a = \mathbf{E}_{\perp}^a|_{\text{foc}} - \frac{\partial \phi^a}{\partial \mathbf{x}_{\perp}}$$

$\mathbf{E}_{\perp}^a|_{\text{foc}}$ = Fields from Any Applied Focusing Optics

$$-\frac{\partial \phi^a}{\partial \mathbf{x}_{\perp}} \simeq \frac{1}{2} \frac{\partial^2}{\partial z^2} V(z) \mathbf{x}_{\perp} = \text{Focusing Field from Acceleration}$$

- ◆ Results can be used to cast acceleration terms in more convenient forms. See J.J. Barnard, **Intro. Lectures** for more details.
- ◆ RF defocusing in the quasistatic approximation can be analyzed using this formulation
- ◆ Einzel lens focusing exploits accel/de-acell cycle to make AG focusing

S12: Symplectic Formulation of Dynamics

S12A: Expression of Hamiltonian Dynamics

Following Lectures by:
Andy Wolski,
U. Liverpool

Hamilton's form of the equations of motion for a coasting beam (no accel):

- For solenoid focusing, will need to employ appropriate canonical variables (see S2G)

$$\frac{d}{ds} \mathbf{x}_{\perp} = \frac{\partial H_{\perp}}{\partial \mathbf{x}'_{\perp}} \quad \frac{d}{ds} \mathbf{x}'_{\perp} = -\frac{\partial H_{\perp}}{\partial \mathbf{x}_{\perp}} \quad (\text{see S2G})$$

can be equivalently expressed as:

$$\frac{d}{ds} \vec{x} = \mathbf{S} \cdot \nabla_{\vec{x}} H_{\perp}$$

where

$$\vec{x} \equiv \begin{bmatrix} x \\ x' \\ y \\ y' \end{bmatrix} \quad \nabla_{\vec{x}} \equiv \begin{bmatrix} \partial_x \\ \partial_{x'} \\ \partial_y \\ \partial_{y'} \end{bmatrix} \quad \mathbf{S} \equiv \begin{bmatrix} \mathbf{S}_2 & \mathbf{0} \\ \mathbf{0} & \mathbf{S}_2 \end{bmatrix}$$

$$\mathbf{S}_2 \equiv \begin{bmatrix} 0 & 1 \\ -1 & 0 \end{bmatrix}$$

- Immediately generalizable to 3D dynamics
- Formulation applies in general cononical variables

$$s \rightarrow t \quad x \rightarrow q \quad x' \rightarrow p \quad \text{etc.}$$

// Review Transverse Hamiltonian formulation: for coasting beam
($\gamma_b \beta_b = \text{const}$)

1) Continuous or quadrupole (electric or magnetic) focusing:

Canonical variables:

$$x, x' \quad y, y'$$

Hamiltonian:

$$H_{\perp} = \frac{1}{2}x'^2 + \frac{1}{2}y'^2 + \frac{1}{2}\kappa_x x^2 + \frac{1}{2}\kappa_y y^2 + \frac{q\phi}{m\gamma_b^3\beta_b^2 c^3}$$
$$\frac{d}{ds}x = \frac{\partial H_{\perp}}{\partial x} \quad \frac{d}{ds}x = \frac{\partial H_{\perp}}{\partial y}$$
$$\frac{d}{ds}x' = -\frac{\partial H_{\perp}}{\partial x'} \quad \frac{d}{ds}y' = -\frac{\partial H_{\perp}}{\partial y'}$$

Giving the familiar equations of motion:

$$x'' + \kappa_x x = -\frac{q}{m\gamma_b^3\beta_b^2 c^2} \frac{\partial \phi}{\partial x}$$
$$y'' + \kappa_y y = -\frac{q}{m\gamma_b^3\beta_b^2 c^2} \frac{\partial \phi}{\partial y}$$

Solenoidal magnetic focusing:

Canonical variables:

$$\begin{aligned}\tilde{x} &= x & \tilde{y} &= y \\ \tilde{x}' &= x' - \frac{B_{z0}}{2[B\rho]}y & \tilde{y}' &= y' + \frac{B_{z0}}{2[B\rho]}x\end{aligned}\quad [B\rho] \equiv \frac{m\gamma_b\beta_b c}{q}$$

Hamiltonian:

$$\tilde{H}_\perp = \frac{1}{2} \left[\left(\tilde{x}' + \frac{B_{z0}}{2[B\rho]} \tilde{y} \right)^2 + \left(\tilde{y}' - \frac{B_{z0}}{2[B\rho]} \tilde{x} \right)^2 \right] + \frac{q\phi}{m\gamma_b^3\beta_b^2 c^3}$$

$$\frac{d}{ds} \tilde{x} = \frac{\partial \tilde{H}_\perp}{\partial \tilde{x}}$$

$$\frac{d}{ds} \tilde{y} = \frac{\partial \tilde{H}_\perp}{\partial \tilde{y}}$$

Caution:

Primes do not mean d/ds in tilde variables here: just notation to distinguish “momentum” variable!

$$\frac{d}{ds} \tilde{x}' = -\frac{\partial \tilde{H}_\perp}{\partial \tilde{x}'}$$

$$\frac{d}{ds} \tilde{y}' = -\frac{\partial \tilde{H}_\perp}{\partial \tilde{y}'}$$

Giving (after some algebra) the familiar equations of motion:

$$x'' - \frac{B'_{z0}(s)}{2[B\rho]}y - \frac{B_{z0}(s)}{[B\rho]}y' = -\frac{q}{m\gamma_b^3\beta_b^2 c^2} \frac{\partial \phi}{\partial x}$$

$$y'' + \frac{B'_{z0}(s)}{2[B\rho]}x + \frac{B_{z0}(s)}{[B\rho]}x' = -\frac{q}{m\gamma_b^3\beta_b^2 c^2} \frac{\partial \phi}{\partial y}$$

Symplectic Matrix

Definition:

An $2n \times 2n$ symplectic matrix \mathbf{M} satisfies

$$\mathbf{M}^T \cdot \mathbf{S} \cdot \mathbf{M} = \mathbf{S}$$

where \mathbf{S} has the n -dimensional *block diagonal* structure:

$$\mathbf{S} = \begin{bmatrix} \mathbf{S}_2 & & & \\ & \ddots & & \\ & & \mathbf{0} & \\ & & & \ddots \\ \mathbf{0} & & & & \\ & & & & & \ddots \\ & & & & & & \mathbf{S}_2 \end{bmatrix} \quad \mathbf{S}_2 = \begin{bmatrix} 0 & 1 \\ -1 & 0 \end{bmatrix}$$

The matrix \mathbf{S} satisfies:

- ◆ Follow direct from definition

$$\mathbf{S}^T = -\mathbf{S}$$

$$\mathbf{S}^2 = -\mathbf{I}$$

Illustrative Example: Linear Dynamics with constant applied fields

For a general 2nd order Hamiltonian that generates linear dynamics we have:

$$\nabla_{\vec{x}} H_{\perp} = \mathbf{J} \cdot \vec{x} \quad \text{with} \quad \mathbf{J}^T = \mathbf{J}$$

- ◆ Transpose symmetry result of expected physical forces

Hamilton's equation of motion become:

$$\frac{d}{ds} \vec{x} = \mathbf{S} \cdot \nabla_{\vec{x}} H_{\perp} = \mathbf{S} \cdot \mathbf{J} \cdot \vec{x}$$

If \mathbf{J} has *no explicit s variation*, then this equation can be solved as

- ◆ Applies to piecewise constant focusing systems within each element/drift
 - In context coupled motion ok
 - Transitions between elements need to be analyzed separately

$$\vec{x}(s) = \mathbf{M}(s - s_i) \cdot \vec{x}(s_i) = \exp[(s - s_i)\mathbf{S} \cdot \mathbf{J}] \cdot \vec{x}(s_i)$$

$$\mathbf{M}(s - s_i) = \exp [(s - s_i)\mathbf{S} \cdot \mathbf{J}] \quad \mathbf{M} = \text{Transfer Matrix}$$

- ◆ \mathbf{M} is a potentially higher-dimensional generalization of the previous 1D (2x2) matrix used for Hill's equation and the 2D (4x4) solenoid phase-space transfer matrices employed

Because (see proof on next page):

$$\mathbf{S} \cdot \exp (s\mathbf{S} \cdot \mathbf{J}) = \exp (s\mathbf{J} \cdot \mathbf{S}) \cdot \mathbf{S}$$

$$\mathbf{J}^T = \mathbf{J} \quad \mathbf{S}^T = -\mathbf{S}$$

and for any matrices A and B the transpose property :

$$[\mathbf{A} \cdot \mathbf{B}]^T = \mathbf{B}^T \cdot \mathbf{A}^T$$

The transfer matrix \mathbf{M} is *symplectic*:

$$\mathbf{M}(s - s_i) = \exp [(s - s_i)\mathbf{S} \cdot \mathbf{J}]$$

$$\begin{aligned} \mathbf{M}^T(s) \cdot \mathbf{S} \cdot \mathbf{M}(s) &= [\exp (s\mathbf{S} \cdot \mathbf{J})]^T \cdot \mathbf{S} \cdot \exp (s\mathbf{S} \cdot \mathbf{J}) \\ &= \exp (s[\mathbf{S} \cdot \mathbf{J}]^T) \cdot \exp (s\mathbf{J} \cdot \mathbf{S}) \cdot \mathbf{S} \\ &= \exp (s\mathbf{J}^T \cdot \mathbf{S}^T) \cdot \exp (s\mathbf{J} \cdot \mathbf{S}) \cdot \mathbf{S} \\ &= \exp (-s\mathbf{J} \cdot \mathbf{S}) \cdot \exp (s\mathbf{J} \cdot \mathbf{S}) \cdot \mathbf{S} \\ &= \mathbf{S} \end{aligned}$$

$$\implies \mathbf{M}^T(s) \cdot \mathbf{S} \cdot \mathbf{M}(s) = \mathbf{S}$$

Satisfies symplectic condition

// **Aside** Proof of formula applied:

Definition of the exponential of a matrix \mathbf{A} :

$$\exp(\mathbf{A}) \equiv \sum_{n=0}^{\infty} \frac{\mathbf{A}^n}{n!}$$

Then:

$$\mathbf{S}^2 = -I$$

$$\begin{aligned} \mathbf{S} \cdot \exp(s\mathbf{S} \cdot \mathbf{J}) &= \mathbf{S} \cdot \left(1 + s\mathbf{S} \cdot \mathbf{J} + \frac{1}{2}s^2\mathbf{S} \cdot \mathbf{J} \cdot \mathbf{S} \cdot \mathbf{J} + \dots \right) \\ &= -\mathbf{S} \cdot \left(1 + s\mathbf{S} \cdot \mathbf{J} + \frac{1}{2}s^2\mathbf{S} \cdot \mathbf{J} \cdot \mathbf{S} \cdot \mathbf{J} + \dots \right) \cdot \mathbf{S}^2 \\ &= \left([-\mathbf{S}^2] + s[-\mathbf{S}^2] \cdot \mathbf{J} \cdot \mathbf{S} + \frac{1}{2}s^2[-\mathbf{S}^2]^2 \cdot \mathbf{J} \cdot \mathbf{S} \cdot \mathbf{J} \cdot \mathbf{S} + \dots \right) \\ &= \left(1 + s\mathbf{J} \cdot \mathbf{S} + \frac{1}{2}s^2\mathbf{J} \cdot \mathbf{S} \cdot \mathbf{J} \cdot \mathbf{S} + \dots \right) \cdot \mathbf{S} \\ &= \exp(s\mathbf{J} \cdot \mathbf{S}) \cdot \mathbf{S} \end{aligned}$$

//

Comments:

- ◆ Example presented illustrating symplectic structure of Hamiltonian dynamics only applies to piecewise constant linear forces
- ◆ Generalizations show that the symplectic structure of Hamiltonian dynamics persists into fully general cases with s -dependent Hamiltonians and nonlinear effects. Showing this requires development of more formalisms beyond the scope of this course. See for more info:

A. Dragt, *Lectures on Nonlinear Orbit Dynamics*, in
“Physics of High Energy Accelerators,”
(AIP Conf. Proc. No. 87, New York, 1982), p. 147

2300 page book distributed freely:

Alex Dragt, *Lie Methods for Nonlinear Dynamics with Applications to Accelerator Physics* (2015)

<http://www.physics.umd.edu/dsat/dsatliemethods.html>

- ◆ The symplectic structure of Hamiltonian dynamics is important in numerical codes for long-term tracking of particles in rings
 - Special map-based movers preserve symplectic structure
 - Insures no artificial numerical growth or damping in particle orbits over very long evolution

S12.B: Symplectic Dynamics = Phase-Space Area Preservation

Why the emphasis on the symplectic structure of Hamiltonian dynamics?

Because symplectic dynamics implies that that phase-space area is preserved in the particle evolution.

Illustration: Consider the phase-space area A bounded by two vectors \vec{e}_1, \vec{e}_2 which evolve according to symplectic dynamics

- ◆ Area calculated using cross-product: sketch 1D phase space but works 2D, 3D

$$\begin{aligned} A(s_i) &= |\vec{e}_1(s_i) \otimes \vec{e}_2(s_i)| \\ &= \vec{e}_1^T(s_i) \cdot \mathbf{S} \cdot \vec{e}_2(s_i) \\ &= \text{Initial Area} \end{aligned}$$

$$\begin{aligned} A(s) &= |\vec{e}_1(s) \otimes \vec{e}_2(s)| \\ &= \vec{e}_1^T(s) \cdot \mathbf{S} \cdot \vec{e}_2(s) \\ &= \text{Evolved Area} \end{aligned}$$

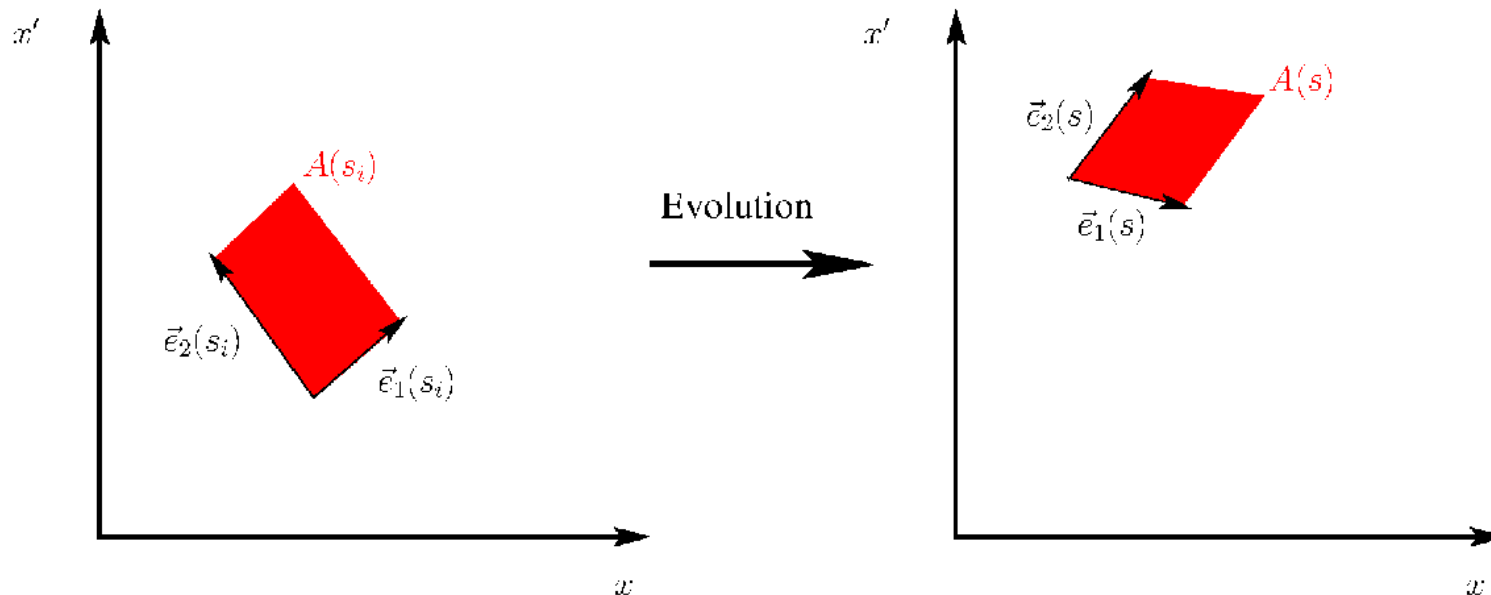

With reference to the same constant field, linear dynamics formulation used to illustrate symplectic dynamics:

Since the vectors evolve according to Hamiltonian dynamics:

$$\vec{e}_1(s) = \mathbf{M}(s - s_i) \cdot \vec{e}_1(s_i)$$

$$\vec{e}_2(s) = \mathbf{M}(s - s_i) \cdot \vec{e}_2(s_i)$$

Thus, since the dynamics is symplectic with $\mathbf{M}^T \cdot \mathbf{S} \cdot \mathbf{M} = \mathbf{S}$

$$\begin{aligned} \text{Evolved Area} = A &= \vec{e}_2^T(s) \cdot \mathbf{S} \cdot \vec{e}_1(s) \\ &= [\mathbf{M}(s - s_i) \cdot \vec{e}_2(s_i)]^T \cdot \mathbf{S} \cdot [\mathbf{M}(s - s_i) \cdot \vec{e}_1(s_i)] \\ &= \vec{e}_2^T(s_i) \cdot [\mathbf{M}^T(s - s_i) \cdot \mathbf{S} \cdot \mathbf{M}(s - s_i)] \cdot \vec{e}_1(s_i) \\ &= \vec{e}_2^T(s_i) \cdot \mathbf{S} \cdot \vec{e}_1(s_i) \\ &= A(s_i) = \text{Initial Area} \end{aligned}$$

Giving the important results:

Symplectic dynamics implies conservation of phase-space area !

Comments:

- ▶ Illustration only applies to linear constant applied fields, but more advanced treatments (see Dragt refs in previous sub-section) show this property persists for s -varying Hamiltonians and nonlinear dynamics.
- ▶ **IMPORTANT:** conservation of phase-space area in nonlinear dynamics in the sense given does *NOT* imply that measures of *statistical* beam emittance calculated by averages over an ensemble of particles remain conserved in nonlinear dynamics
 - ▶ Statistical measures of phase space area (see lectures on **Centroid and Envelope Descriptions** and **Kinetic Stability**) impact beam focusability and can evolve in response to nonlinear effects with important implications
 - Effectively phase-space filaments with coarse grained measures of phase space area evolving
 - ▶ This will be treated more in lectures on **Kinetic Stability**
- ▶ Acceleration can be dealt with by employing a 3D Hamiltonian formulation with a full set of proper canonical variables or using normalized variables in 4D transverse phase-space as outlined in **S10**
- ▶ In numerical analysis of particle orbits in rings it is very important to advance particles that preserve the symplectic structure of the dynamics in the presence of numerical approximations/errors
 - ▶ Characteristics then faithful with those expected in real machine over many laps

S13 Self-Consistent Models and Liouville's Theorem

Follow formulations in:

- ◆ Nicholson, *Introduction to Plasma Physics*, Wiley, 1982
- ◆ JJ Barnard, **Introductory Lectures**

Note are included here for completeness. We return to a more complete (3D) formulation of the beam description in this section. Only an outline is given: plasma physics texts such as Nicholson should be consulted for more details.

Material in this section help motivate the collective (Vlasov) evolution models employed in later lecture notes that we often employ to describe the self-consistent evolution of intense beams. These models will typically be expressed in variables appropriate for paraxial beam models. Here, we outline the more complete setup for better orientation.

S13.A: Klimontovich Equation for Self-Consistent Description of Beam/Plasma Evolution

Consider the evolution of N particles coupled to the Maxwell equations and describe the evolution in terms of a singular phase-space density function F evolving in 6D phase space:

$$F(\mathbf{x}, \mathbf{p}, t) = \sum_{i=1}^N \delta[\mathbf{x} - \mathbf{x}_i(t)] \delta[\mathbf{p} - \mathbf{p}_i(t)]$$

$\mathbf{x}_i(t)$ = Position of i th particle

$\mathbf{p}_i(t)$ = Mechanical momentum of i th particle

t = Time

- ◆ F is highly singular: infinite at location of classical point particles and zero otherwise.
- ◆ Here we implicitly assume a single species with charge q and mass m for simplicity. If there are more than one species, the formulation can be generalized by writing a separate density function for each species: $F \rightarrow F_s$
 - Most steps carry through with little modification outside of changes (sum over species) in coupling to the Maxwell equations. See discussion at end of section.

Note that:

$$\int d^3x \int d^3p F(\mathbf{x}, \mathbf{p}, t) = N = \text{const}$$

Particles evolve consistent with electromagnetic forces of “microscopic” classical point particles according to the Lorentz force equation:

$$\frac{d\mathbf{p}_i}{dt} = \mathbf{F}_i = q \left[\mathbf{E}^m(\mathbf{x}_i, t) + \frac{d\mathbf{x}_i}{dt} \times \mathbf{B}^m(\mathbf{x}_i, t) \right] \quad \text{Initial conditions}$$
$$m\gamma_i \frac{d\mathbf{x}_i}{dt} = \mathbf{p}_i \quad ; \quad \gamma_i = \left[1 + \frac{\mathbf{p}_i^2}{(mc)^2} \right]^{1/2} \quad \begin{array}{l} \mathbf{x}_i(t=0) \\ \mathbf{p}_i(t=0) \end{array}$$

Comments:

- ◆ Here we do not consider quantum mechanical effects in scattering but classical scattering and radiation is allowed consistent with electromagnetic forces
 - Ionizations, internal atom excitations, would require changes in F
- ◆ As written the system applies to one species (i.e., single q , m values) but easy to generalize by writing the same form of F for each species
- ◆ Denote superscript m on field components denote “microscopic” fields

And couple to the full set of microscopic fields (superscript m) via the Maxwell equations:

Charge Density

$$\nabla \cdot \mathbf{E}^m = \frac{\rho}{\epsilon_0}$$

$$\nabla \times \mathbf{E}^m = -\frac{\partial \mathbf{B}^m}{\partial t}$$

$$\rho(\mathbf{x}, t) = \rho_{\text{ext}}(\mathbf{x}, t) + q \sum_i \delta[\mathbf{x} - \mathbf{x}_i(t)]$$

$$= \rho_{\text{ext}}(\mathbf{x}, t) + q \int d^3p F(\mathbf{x}, \mathbf{p}, t)$$

Current Density

$$\nabla \cdot \mathbf{B}^m = 0$$

$$\nabla \times \mathbf{B}^m = \mu_0 \mathbf{J} + \mu_0 \epsilon_0 \frac{\partial \mathbf{E}^m}{\partial t}$$

$$\mathbf{J}(\mathbf{x}, t) = \mathbf{J}_{\text{ext}}(\mathbf{x}, t) + q \sum_i \frac{d\mathbf{x}_i}{dt} \delta[\mathbf{x} - \mathbf{x}_i(t)]$$

$$= \mathbf{J}_{\text{ext}}(\mathbf{x}, t) + q \int d^3p \mathbf{v} F(\mathbf{x}, \mathbf{p}, t)$$

$$\mathbf{v} \equiv \frac{\mathbf{p}}{\gamma m} = \frac{\mathbf{p}/m}{[1 + \mathbf{p}^2/(mc)^2]^{1/2}}$$

+ boundary conditions on \mathbf{E}^m , \mathbf{B}^m

external
(applied)

particle
beam

Comments:

- ◆ Full form of Maxwell equations allow classical electromagnetic radiation
- ◆ Coupling to beam charge and current is shown for one species, but easy to generalize by summing contributions from all species

Derive an evolution equation for F :

$$\begin{aligned} \frac{\partial F}{\partial t}(\mathbf{x}, \mathbf{p}, t) &= - \sum_{i=1}^N \left[\frac{d\mathbf{x}_i(t)}{dt} \cdot \nabla_{\mathbf{x}} + \frac{d\mathbf{p}_i(t)}{dt} \cdot \nabla_{\mathbf{p}} \right] \delta[\mathbf{x} - \mathbf{x}_i(t)] \delta[\mathbf{p} - \mathbf{p}_i(t)] \\ &= - \sum_{i=1}^N \left[\frac{d\mathbf{x}_i(t)}{dt} \cdot \nabla_{\mathbf{x}} + q \left[\mathbf{E}^m(\mathbf{x}_i, \mathbf{p}_i, t) + \frac{d\mathbf{x}_i(t)}{dt} \times \mathbf{B}^m(\mathbf{x}_i, \mathbf{p}_i, t) \right] \cdot \nabla_{\mathbf{p}} \right] \\ &\quad \delta[\mathbf{x} - \mathbf{x}_i(t)] \delta[\mathbf{p} - \mathbf{p}_i(t)] \end{aligned}$$

But:

$$\mathbf{x} \delta[\mathbf{x} - \mathbf{x}_i(t)] \delta[\mathbf{p} - \mathbf{p}_i(t)] = \mathbf{x}_i(t) \delta[\mathbf{x} - \mathbf{x}_i(t)] \delta[\mathbf{p} - \mathbf{p}_i(t)] \quad \text{etc.}$$

$$\mathbf{v} = \frac{\mathbf{p}}{\gamma m} = \frac{\mathbf{p}/m}{[1 + \mathbf{p}^2/(mc)^2]^{1/2}}$$

Giving, after some manipulation, the [Klimontovich equation](#) describing the classical collective evolution of the beam as:

$$\left\{ \frac{\partial}{\partial t} + \mathbf{v} \cdot \nabla_{\mathbf{x}} + q \left[\mathbf{E}^m(\mathbf{x}, \mathbf{p}, t) + \mathbf{v} \times \mathbf{B}^m(\mathbf{x}, \mathbf{p}, t) \right] \cdot \nabla_{\mathbf{p}} \right\} F(\mathbf{x}, \mathbf{p}, t) = 0$$

$$F(\mathbf{x}, \mathbf{p}, t) \equiv \sum_{i=1}^N \delta[\mathbf{x} - \mathbf{x}_i(t)] \delta[\mathbf{p} - \mathbf{p}_i(t)]$$

The derivative operator is recognized as acting along a particle orbit:

- ◆ Apply Lorentz force equation

$$\begin{aligned} & \left\{ \frac{\partial}{\partial t} + \mathbf{v} \cdot \nabla_{\mathbf{x}} + q [\mathbf{E}^m(\mathbf{x}, \mathbf{p}, t) + \mathbf{v} \times \mathbf{B}^m(\mathbf{x}, \mathbf{p}, t)] \cdot \nabla_{\mathbf{p}} \right\} F(\mathbf{x}, \mathbf{p}, t) \\ &= \left\{ \frac{\partial}{\partial t} + \frac{d\mathbf{x}_i(t)}{dt} \cdot \nabla_{\mathbf{x}} + \frac{d\mathbf{p}_i(t)}{dt} \cdot \nabla_{\mathbf{p}} \right\} F(\mathbf{x}, \mathbf{p}, t) \\ &= \frac{d}{dt} \Big|_{\text{orbit}} F(\mathbf{x}, \mathbf{p}, t) \end{aligned}$$

Showing that the Klimontovich equation can be alternatively expressed as :

$$\frac{d}{dt} \Big|_{\text{orbit}} F(\mathbf{x}, \mathbf{p}, t) = 0$$

- ◆ Shows F is advected along characteristic particle orbits and is conserved
 - Orbits in this sense are trajectories of “marker” particles (same q/m as physical particles) evolving in the beam

Alternatively, some manipulations show that the Klimontovich equation can be expressed in the form of a higher dimensional relativistic continuity equation:

$$\mathbf{F} \equiv q [\mathbf{E}^m(\mathbf{x}, t) + \mathbf{v} \times \mathbf{B}^m(\mathbf{x}, t)]$$

$$\mathbf{v} = \frac{\mathbf{p}}{\gamma m} = \frac{\mathbf{p}/m}{[1 + \mathbf{p}^2/(mc)^2]^{1/2}}$$

$$\implies \nabla_{\mathbf{p}} \cdot \mathbf{F} = 0$$

Giving:

$$\frac{\partial}{\partial t} F(\mathbf{x}, \mathbf{p}, t) + \nabla_{\mathbf{x}} \cdot [\mathbf{v} F(\mathbf{x}, \mathbf{p}, t)] + \nabla_{\mathbf{p}} \cdot [\mathbf{F} F(\mathbf{x}, \mathbf{p}, t)] = 0$$

- ◆ Shows F is conserved in sense probability flows rather than created/destroyed
- ◆ Can apply analogy with familiar continuity equation in fluid mechanics (see [Aside](#) next page) to help interpret

// Aside: Analogy with the familiar continuity equation of a local fluid density n :

$$\frac{\partial}{\partial t} n(\mathbf{x}, t) + \nabla_{\mathbf{x}} \cdot [n(\mathbf{x}, t) \mathbf{V}(\mathbf{x}, t)] = 0$$

$n(\mathbf{x}, t)$ = Fluid number density

$\mathbf{V}(\mathbf{x}, t)$ = Fluid flow velocity

- Shows fluid density n flows somewhere consistent with the fluid flow \mathbf{V} and is not created/destroyed
- n is conserved in this sense and the continuity equation is the proper expression of local conservation
- Implies fluid weight not created or destroyed. Integrate over some volume V containing all fluid ($n = 0$ on surface)

$$\int_V d^3x \left\{ \frac{\partial}{\partial t} n(\mathbf{x}, t) + \nabla_{\mathbf{x}} \cdot [n(\mathbf{x}, t) \mathbf{V}(\mathbf{x}, t)] \right\} = 0$$

$$\frac{\partial}{\partial t} \int_V d^3x n(\mathbf{x}, t) + \int_{\partial V} d^2x n(\mathbf{x}, t) \mathbf{V}(\mathbf{x}, t) \cdot \hat{\mathbf{n}}(\mathbf{x}) = 0$$

applied Divergence Theorem: ∂V = Surface bounding V
 $\hat{\mathbf{n}}(\mathbf{x})$ = Local unit normal to ∂V

$$\frac{\partial}{\partial t} \int_V d^3x n(\mathbf{x}, t) = 0 \quad \Rightarrow \quad \int_V d^3x n(\mathbf{x}, t) = \text{const}$$

//

Comments on the Klimontovich formulation:

- ◆ Solved as an initial value problem: initial particle phase-space coordinates of particles specified and then solved with coupled Maxwell equations
 - Classically exact, but practically speaking intractable
 - Really just a restatement of classical point particles evolving consistently with the Maxwell equations: mostly just notation at this point
- ◆ Klimontovich equation is essentially a statement that local density in phase-space is conserved in the classical evolution of a charged particle system
 - Quantum theory of matter can change expression since collisions of particles can cause effects like ionization, internal atom excitations,
 - Klimontovich equation can be modified by including appropriate terms on the RHS of equation to model such classical and quantum scattering effects: would result in non-conservation of probabilities associated with quantum effects in “collisions”
- ◆ Sometimes called [Liouville's theorem](#) in micro-space
- ◆ Not particularly useful in this form other than conceptual grounding. Need an expression in terms of a *smoothed statistical measure* of the particle distribution. We construct this next section.

S13.B: Vlasov's Equation and the Liouville's theorem

Average of the singular (micro) Klimontovich distribution f to obtain a smooth $6D$ phase-space distribution

Δx = Position width

Δp = Momentum width

$$f(\mathbf{x}, \mathbf{p}, t) \equiv \frac{1}{\Delta x^3 \Delta p^3} \int_{\Delta x^3} d^3 x \int_{\Delta p^3} d^3 p F(\mathbf{x}, \mathbf{p}, t) = \langle F(\mathbf{x}, \mathbf{p}, t) \rangle$$

- ◆ Average taken about local phase-space coordinates \mathbf{x}, \mathbf{p} so after averaging, dependence of distribution remains in \mathbf{x}, \mathbf{p}
- ◆ Average is essentially a coarse-graining to reduce detail

Arguments can be involved in taking appropriate coarse-grain measurements.

Logic from plasma physics suggests:

n = Characteristic number density

$$n^{-1/3} \ll \Delta x \ll \lambda_D$$

$$\lambda_D = \left(\frac{\epsilon_0 T}{q^2 n} \right)^{1/2} = \text{Thermal debye length}$$

$$0 \ll \Delta p \ll m v_t$$

$$v_t = \left(\frac{T}{m} \right)^{1/2} = \text{Thermal velocity}$$

Better defining some of these measures:

- ♦ Take a nonrelativistic perspective here for simplicity

T = Characteristic kinetic temperature (energy units)

$$\frac{1}{2}T = \frac{1}{2}mv_t^2 \quad \Longrightarrow \quad v_t = \left(\frac{T}{m}\right)^{1/2} = \text{Thermal velocity}$$

- ♦ Kinetic temperature removing local flow measures (beam frame) of beam and measures strength of random spread of particle momentum
 - ▶ Relativity introduces some subtleties on how to best do this. See Reiser textbook for a thorough discussion.

$$\lambda_D \equiv \frac{(T/m)^{1/2}}{\omega_p} = \frac{v_t}{\omega_p} = \left(\frac{\epsilon_0 T}{q^2 n}\right)^{1/2} = \text{Debye length}$$

- ♦ Characteristic screening/shielding distance within a plasma

$$\omega_p = \left(\frac{q^2 n}{\epsilon_0 m}\right)^{1/2} = \text{Plasma frequency}$$

- ♦ Characteristic collective oscillation frequency of electrostatic restoring forces in a plasma

Examine the local deviations of the distribution from the smoothed average:

$$F = f + \delta f$$

$$f \equiv \langle F \rangle \quad \Longrightarrow \quad \langle \delta f \rangle = 0$$

- ◆ Dependence of all distribution terms $(\mathbf{x}, \mathbf{p}, t)$

And make similar definitions for smoothed field components:

$$\begin{array}{lll} \mathbf{E}^m = \mathbf{E} + \delta \mathbf{E} & \mathbf{E} \equiv \langle \mathbf{E}^m \rangle & \langle \delta \mathbf{E} \rangle = 0 \\ \mathbf{B}^m = \mathbf{B} + \delta \mathbf{B} & \mathbf{B} \equiv \langle \mathbf{B}^m \rangle & \langle \delta \mathbf{B} \rangle = 0 \end{array} \quad \Longrightarrow$$

- ◆ Dependence of all field terms (\mathbf{x}, t)

Averaging over the Kilmontovich equation in [S13A](#) then obtains:

$$\left\{ \frac{\partial}{\partial t} + \mathbf{v} \cdot \frac{\partial}{\partial \mathbf{x}} + q [\mathbf{E}(\mathbf{x}, t) + \mathbf{v} \times \mathbf{B}(\mathbf{x}, t)] \cdot \frac{\partial}{\partial \mathbf{p}} \right\} f(\mathbf{x}, \mathbf{p}, t) = -q \langle [\delta \mathbf{E}(\mathbf{x}, t) + \mathbf{v} \times \delta \mathbf{B}(\mathbf{x}, t)] \delta f(\mathbf{x}, \mathbf{p}, t) \rangle$$

Averaging over the microscopic Maxwell equations then gives the Maxwell equations for the smoothed fields:

- Equations are linear, so average is trivial. But coupling form to beam charges and currents changes to average form representing smoothed charge and current densities

$$\begin{aligned} \nabla \cdot \mathbf{E} &= \frac{\rho}{\epsilon_0} & \rho(\mathbf{x}, t) &= \rho_{\text{ext}}(\mathbf{x}, t) + q \int d^3p f(\mathbf{x}, \mathbf{p}, t) \\ \nabla \times \mathbf{E} &= -\frac{\partial \mathbf{B}}{\partial t} \\ \nabla \cdot \mathbf{B} &= 0 \\ \nabla \times \mathbf{B} &= \mu_0 \mathbf{J} + \mu_0 \epsilon_0 \frac{\partial \mathbf{E}}{\partial t} & \mathbf{J}(\mathbf{x}, t) &= \mathbf{J}_{\text{ext}}(\mathbf{x}, t) + q \int d^3p \mathbf{v} f(\mathbf{x}, \mathbf{p}, t) \end{aligned}$$

+ boundary conditions on \mathbf{E} , \mathbf{B}

The fields can also be given, as usual, with potentials ϕ , \mathbf{A}

- Specific form of potential equations and coupling to ρ , \mathbf{J} depend on the gauge choices made: consult classical electrodynamics textbooks for details

$$\mathbf{E} = -\nabla\phi + \frac{\partial \mathbf{A}}{\partial t}$$

$$\mathbf{B} = \nabla \times \mathbf{A}$$

In this averaged equation:

$$\text{LHS:} \quad \left\{ \frac{\partial}{\partial t} + \mathbf{v} \cdot \frac{\partial}{\partial \mathbf{x}} + q [\mathbf{E}(\mathbf{x}, t) + \mathbf{v} \times \mathbf{B}(\mathbf{x}, t)] \cdot \frac{\partial}{\partial \mathbf{p}} \right\} f(\mathbf{x}, \mathbf{p}, t)$$

- ◆ Represents the smoothly (continuum model theory) varying part
 - No scattering effects but retains self-consistent collective effects
 - Appropriate to model many (fluid like) particles interacting

$$\text{RHS:} \quad -q \langle [\delta \mathbf{E}(\mathbf{x}, t) + \mathbf{v} \times \delta \mathbf{B}(\mathbf{x}, t)] \delta f(\mathbf{x}, \mathbf{p}, t) \rangle$$

- ◆ Represents an averaged interaction over rapidly varying quantities
- ◆ Retains information from classical discrete particle effects and collisions
 - In form given has no quantum mechanical effects such as ionizations, internal atom excitations, Model must be further augmented to analyze such effects
- ◆ Extensive treatments in plasma physics involve making approximations for this classical “collision operator” to statistically model scattering effects in plasmas
 - Beyond scope of this course: see treatments and references in Nicholson and other plasma physics texts
- ◆ Will outline arguments that classical scattering effects associated with this term are negligible in many cases relevant to intense beam physics

When scattering effects on the RHS can be neglected, the evolution equation is approximated by the **Vlasov equation**:

$$\left\{ \frac{\partial}{\partial t} + \mathbf{v} \cdot \frac{\partial}{\partial \mathbf{x}} + q [\mathbf{E}(\mathbf{x}, t) + \mathbf{v} \times \mathbf{B}(\mathbf{x}, t)] \cdot \frac{\partial}{\partial \mathbf{p}} \right\} f(\mathbf{x}, \mathbf{p}, t) = 0$$

Here,
$$\mathbf{v} = \frac{\mathbf{p}}{\gamma m} = \frac{\mathbf{p}/m}{[1 + \mathbf{p}^2/(mc)^2]^{1/2}}$$

- ◆ Describes the evolution of the system in a classical continuum model sense
 - Includes collective effects
 - Does not include scattering and quantum mechanical effects
- ◆ Solved as an initial value problem with $f(\mathbf{x}, \mathbf{p}, t = 0)$ specified and the fields given by the smoothed Maxwell equations

Simple estimates on when scattering can be neglected

- ◆ For more details consult plasma physics texts
- ◆ Take a nonrelativistic perspective for simplicity
- ◆ Use previous scales employed in coarse grain averages used to obtain f

Heuristically, on the RHS scattering term take:

$$\text{RHS} = -q \langle [\delta \mathbf{E} + \mathbf{v} \times \delta \mathbf{B}] \delta f \rangle \sim \nu_c f$$

$$\nu_c \sim \sigma n v_t = \text{Collision frequency}$$

$$\sigma \sim \pi r_c^2 = \text{Collision cross-section}$$

Estimate cross section by considering a large angle scatter where the thermal energy of the incident particle is of order the electrostatic potential energy at closest approach:

$$T = \frac{q^2}{4\pi\epsilon_0 r_c} \quad \implies r_c \sim \frac{q^2}{4\pi\epsilon_0 T} = \text{collision radius}$$

$$\implies \nu_c \sim (\pi r_c^2) n v_t \sim \pi \left(\frac{q^2}{4\pi\epsilon_0 T} \right)^2 n \left(\frac{T}{m} \right)^{1/2} \sim \frac{1}{16\pi} \frac{v_t}{\lambda_D^4 n}$$

$$\text{RHS} = -q \langle [\delta \mathbf{E} + \mathbf{v} \times \delta \mathbf{B}] \delta f \rangle \sim \nu_c f \sim \frac{1}{16\pi} \frac{v_t}{\lambda_D^4 n} f$$

Heuristically, on the LHS collective term expect for electrostatic effects:

$$\text{LHS} = \left\{ \frac{\partial}{\partial t} + \mathbf{v} \cdot \frac{\partial}{\partial \mathbf{x}} + q [\mathbf{E} + \mathbf{v} \times \mathbf{B}] \cdot \frac{\partial}{\partial \mathbf{p}} \right\} f \sim \omega_p f$$

$$\omega_p = \left(\frac{q^2 n}{\epsilon_0 m} \right)^{1/2} = \text{Angular frequency of plasma oscillations}$$

The relative order of the LHS (collective) and RHS (classical scattering) terms are:

$$\frac{\text{RHS}}{\text{LHS}} = \frac{\text{Collisions}}{\text{Collective}} \sim \frac{1}{16\pi} \frac{v_t}{\lambda_D^4 n} \frac{1}{\omega_p} = \frac{1}{16\pi \lambda_D^3 n} \sim \frac{1}{\Lambda}$$

$$\Lambda \equiv \frac{4\pi}{3} \lambda_D^3 n = \text{Particles per Debye sphere}$$

$\gg 1$ for intense beams

We expect scattering effects to be weak relative to collective effects for typical intense beams

- ◆ Special situations can change this: very cold beams near source
- ◆ Arguments here on ordering are somewhat circular but show consistency. To more rigorously motivate, usually careful comparisons with more complete models are necessary.
- Many studies in field motivate Vlasov model typically good for intense beams

Interpretation of Vlasov's Equation

The Vlasov Equation is essentially a continuity equation for an incompressible “fluid” in 6D phase-space. To see this, cast in standard continuity equation form using

$$\frac{\partial}{\partial \mathbf{p}} \cdot \mathbf{v} \times \mathbf{B} = 0$$

To express the Vlasov equation equivalently as

$$\frac{\partial f}{\partial t} + \frac{\partial}{\partial \mathbf{x}} \cdot (\mathbf{v} f) + \frac{\partial}{\partial \mathbf{p}} \cdot (q[\mathbf{E} + \mathbf{v} \times \mathbf{B}] f) = 0$$

- ◆ Manifestly the form of a continuity equation in 6D phase-space, i.e., “probability” f is not created or destroyed

Alternatively, we note that the total derivative along a single particle orbit in the continuum model is

$$\frac{\partial}{\partial t} + \mathbf{v} \cdot \frac{\partial}{\partial \mathbf{x}} + q[\mathbf{E} + \mathbf{v} \times \mathbf{B}] \cdot \frac{\partial}{\partial \mathbf{p}} = \left. \frac{d}{dt} \right|_{\text{orbit}}$$

So the Vlasov equation can be equivalently expressed as

$$\left. \frac{d}{dt} \right|_{\text{orbit}} f(\mathbf{x}, \mathbf{p}, t) = 0$$

- ◆ Expresses that f is advected along characteristic particle orbits in the continuum and is therefore manifestly conserved

Liouville's Theorem

These prove Liouville's theorem:

The density of particles in 6D phase-space is invariant when measured along the trajectories of characteristic particles

Comments:

- ◆ Although density in phase-space remains constant by Liouville's theorem, the shape in phase-space can vary in response to evolution and nonlinear effects
 - Distortions and Filamentation
- ◆ Consequently, coarse-grained or statistical measures of beam phase-space area such as rms emittances can evolve
 - Rms emittances provide important measures of statistical beam focusability
 - (see lectures on **Transverse Centroid and Envelope Descriptions**)
- ◆ Proved here using position-mechanical momentum phase space (\mathbf{x}, \mathbf{p}) : later will show valid for all choices of canonical variables
- ◆ Valid in continuum mechanics approximation with average (mean field) self-consistent effects. Both classical scattering and quantum mechanical scattering processes result in violations of Liouville's theorem
 - Classical scattering tends to decrease density in phase-space
- ◆ Numerous versions in literature: often simplest case given for non-interacting particles evolving in response to prescribed forces

Phase-space area measures and Liouville's theorem

A recurring theme in this course is that nonlinear forces acting on a beam can tend to filament phase space. Schematically:

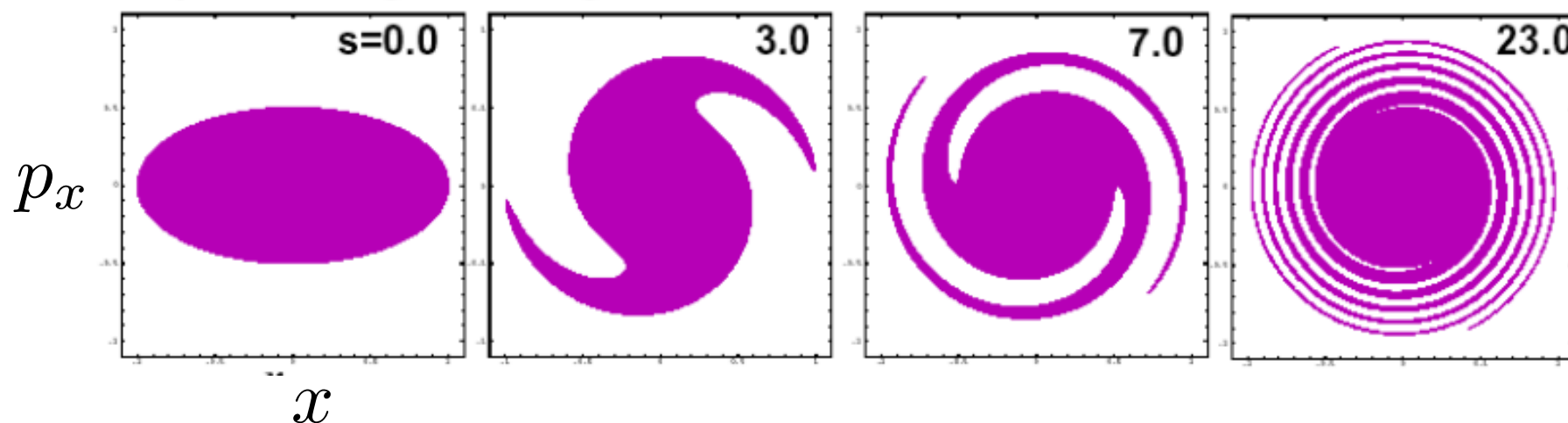

Although phase-space area is conserved in such processes under Liouville's theorem, statistical projection measures of beam phase-space area such as rms beam emittances can evolve and tend to increase under the action of such effects.

$$\text{Projected Statistical Emittance} \sim \left[\langle x^2 \rangle_{\perp} \langle p_x^2 \rangle_{\perp} - \langle xp_x \rangle_{\perp}^2 \right]^{1/2}$$

(rms measure)

- ♦ Much more on this topic in lecture sets on: **Transverse Equilibrium Distributions, Transverse Centroid and Envelope Descriptions, and Transverse Kinetic Stability**

Canonical Variables, Vlasov's Equation, and a Generalized Expression of Liouville's Theorem

Louville's theorem derived for a distribution expressed as a function of position-*mechanical* momentum variables (\mathbf{x}, \mathbf{p}) Here we will show that the same statement holds for any proper set of canonical variables to generalize the interpretation of the Liouville Theorem.

- Note that (\mathbf{x}, \mathbf{p}) variables are not necessarily a proper canonical pair in all relevant focusing systems considered: e.g., solenoid focusing, see the discussion in **S12**

Consider a proper set of canonical variables from which a Hamiltonian H describes the continuum model trajectories consistent with the mean field model potentials ϕ, \mathbf{A}

$$\begin{aligned} q_i &= \text{Canonical Coordinate} & \frac{d}{dt}q_i &= \frac{\partial H}{\partial p_i} & H &= H(\{q_i\}, \{p_i\}, t) \\ p_i &= \text{Canonical Momentum} & \frac{d}{dt}p_i &= -\frac{\partial H}{\partial q_i} \\ i &= 1, 2, 3 \end{aligned}$$

Next, we take the Vlasov model distribution f to be a function of the canonical variables

$$f = f(\{q_i\}, \{p_i\}, t)$$

On general grounds, the distribution should evolve consistent with a continuity equation expressed in the canonical variables. We form this as:

$$\frac{\partial f}{\partial t} + \nabla_6 \cdot (\vec{v}_6 f) = 0$$

where

$$\vec{v}_6 = \begin{bmatrix} \dot{q}_1 \\ \dot{p}_1 \\ \dot{q}_2 \\ \dot{p}_2 \\ \dot{q}_3 \\ \dot{p}_3 \end{bmatrix}$$

$$\nabla_6 \cdot \vec{A}_6 \equiv \sum_{i=1}^3 \left[\frac{\partial A_i}{\partial q_i} + \frac{\partial A_i}{\partial p_i} \right]$$

$\vec{A}_6 \equiv$ 6-vector in obvious notation

$$\cdot \equiv \frac{d}{dt}$$

Then using Hamilton's equations of motion of the characteristics:

$$\nabla_6 \cdot \vec{v}_6 = \sum_{i=1}^3 \left[\frac{\partial \dot{q}_i}{\partial q_i} + \frac{\partial \dot{p}_i}{\partial p_i} \right] = \sum_{i=1}^3 \left[\frac{\partial^2 H}{\partial q_i \partial p_i} - \frac{\partial^2 H}{\partial p_i \partial q_i} \right] = 0$$

So:

$$\frac{\partial f}{\partial t} + \nabla_6 \cdot (\vec{v}_6 f) = \frac{\partial f}{\partial t} + \nabla_6 \cdot \vec{v}_6 f + \vec{v}_6 \cdot \nabla_6 f = 0$$

$$\implies \frac{\partial f}{\partial t} + \vec{v}_6 \cdot \nabla_6 f = \left. \frac{d}{dt} \right|_{\text{orbit}} f = 0$$

Expected incompressible flow form

This shows that the distribution f evaluated along characteristic trajectories in any set of canonical variables remains invariant in the Vlasov model

- ◆ Liouville's theorem remains valid in any set of canonical variables

It is useful to also express the incompressible Vlasov equation in canonical variables:

$$\frac{\partial f}{\partial t} + \vec{v}_6 \cdot \nabla_6 f = 0$$

$$\frac{\partial f}{\partial t} + \sum_{i=1}^3 \left\{ \dot{q}_i \frac{\partial f}{\partial q_i} + \dot{p}_i \frac{\partial f}{\partial p_i} \right\} = 0$$

$$\implies \boxed{\frac{\partial f}{\partial t} + \sum_{i=1}^3 \left\{ \frac{\partial H}{\partial p_i} \frac{\partial f}{\partial q_i} - \frac{\partial H}{\partial q_i} \frac{\partial f}{\partial p_i} \right\}} = 0 \quad \text{Canonical form of Vlasov's equation}$$

- ◆ See electrodynamics texts for form of H with (mean field) potentials ϕ , \mathbf{A} and various canonical variable choices

In the literature, sometimes

$$\{ H, f \} \equiv \left\{ \frac{\partial H}{\partial p_i} \frac{\partial f}{\partial q_i} - \frac{\partial H}{\partial q_i} \frac{\partial f}{\partial p_i} \right\}$$

is called a *Poisson Bracket*

Further insight can be obtained on the canonical form of the Vlasov distribution by transforming from one set of canonical variables to another. Since $f d^3 q d^3 p$ is the physical number of particles (counting) and invariant with the choice of variables used to describe the problem, we have under canonical transform:

$$f d^3 q d^3 p = \tilde{f} d^3 \tilde{q} d^3 \tilde{p}$$

$\tilde{q}_i =$ Transformed canonical coordinate

$\tilde{p}_i =$ Transformed canonical momentum

$\tilde{H} = \tilde{H}(\{\tilde{q}_i, \}, \{\tilde{p}_i\}, \tilde{t}) =$ Transformed Hamiltonian

- ◆ Canonical form is maintained in the transformed variables

In classical mechanics texts, canonical transform generating functions are used to prove that phase space area measures are invariant under canonical transform:

$$d^3 q d^3 p = d^3 \tilde{q} d^3 \tilde{p}$$

Therefore, the Vlasov distribution f is invariant under canonical transform:

$$f(\{q_i\}, \{p_i\}, t) = \tilde{f}(\{\tilde{q}_i\}, \{\tilde{p}_i\}, \tilde{t})$$

Comments:

- ◆ Pure transverse theories of an accelerating beam cannot be cast in terms of a Hamiltonian theory. This is due to the acceleration induced damping terms like:

$$\frac{(\gamma_b \beta_b)'}{(\gamma_b \beta_b)} x'$$

in transverse particle equations of motion.

- For a coasting beam without acceleration or solenoid magnetic focusing x, x', y, y' form a convenient canonical set: these are used extensively in this context in following lecture sets
- ◆ Use of normalized variables (see **S10**) can approximately bypass this limitation in transverse paraxial theories
- ◆ The canonical variables used in the 3D formulation here can include acceleration effects and can be thought of as “normalized” 3D variables
- ◆ Dimensionality and the scope of what is included (acceleration etc) in the Hamiltonian can cause confusion!
 - Clear concept of context, scope, and limitations can help clarify

Multispecies Generalizations for Vlasov Formulation

Subscript species with s . Then in the Vlasov equation replace:

$$f \longrightarrow f_s$$

$$m \longrightarrow m_s$$

$$q \longrightarrow q_s$$

and there is a separate Vlasov equation for each of the s species.

- ◆ Species Vlasov equations couple through self-field terms

Replace the charge and current density couplings in the Maxwell Equations with and appropriate form to include charge and current contributions from all species:

$$\rho(\mathbf{x}, t) = \rho_{\text{ext}}(\mathbf{x}, t) + \sum_s q_s \int d^3p f_s(\mathbf{x}, \mathbf{p}, t)$$

$$\mathbf{J}(\mathbf{x}, t) = \mathbf{J}_{\text{ext}}(\mathbf{x}, t) + \sum_s q_s \int d^3p \mathbf{v} f_s(\mathbf{x}, \mathbf{p}, t)$$

Comment:

- ◆ Analogous replacements apply to Kilmontovich formulation and if scattering terms are retained on the RHS of Vlasov's equation

Corrections and suggestions for improvements welcome!

These notes will be corrected and expanded for reference and for use in future editions of US Particle Accelerator School (USPAS) and Michigan State University (MSU) courses. Contact:

Prof. Steven M. Lund
Facility for Rare Isotope Beams
Michigan State University
640 South Shaw Lane
East Lansing, MI 48824

lund@frib.msu.edu

(517) 908 – 7291 office

(510) 459 - 4045 mobile

Please provide corrections with respect to the present archived version at:

https://people.nslc.msu.edu/~lund/uspas/bpisc_2015

Redistributions of class material welcome. Please do not remove author credits.

References: For more information see:

These course notes are posted with updates, corrections, and supplemental material at:

https://people.nsl.msui.edu/~lund/uspas/bpisc_2015

Materials associated with previous and related versions of this course are archived at:

JJ Barnard and SM Lund, *Beam Physics with Intense Space-Charge*, USPAS:

http://hifweb.lbl.gov/USPAS_2011 2011 Lecture Notes + Info

https://people.nsl.msui.edu/~lund/uspas/bpisc_2015

<http://uspas.fnal.gov/programs/past-programs.shtml> (2008, 2006, 2004)

JJ Barnard and SM Lund, *Interaction of Intense Charged Particle Beams with Electric and Magnetic Fields*, UC Berkeley, Nuclear Engineering NE290H

<http://hifweb.lbl.gov/NE290H> 2009 Lecture Notes + Info

References: continued (2)

Basic introduction on many of the topics covered:

M. Reiser, *Theory and Design of Charged Particle Beams*, Wiley (1994, revised edition 2008)

Hill's Equation, Floquet's theorem, Courant-Snyder invariants, and dispersion functions:

H. Wiedemann, *Particle Accelerator Physics*, Third Edition, Springer (2007)

Particle equations of motion with bends and momentum spread:

D.A. Edwards and M.J. Syphers, *An Introduction to the Physics of High Energy Accelerators*, Wiley (1993)

Original, classic paper on strong focusing and Courant-Snyder invariants applied to accelerator physics. Remains one of the best formulated treatments to date:

E.D. Courant and H. S. Snyder, Theory of the Alternating Gradient Synchrotron, *Annals Physics* **3**, 1 (1958)

Mathematical treatment of transfer matrices and stability:

A. Dragt, *Lectures on Nonlinear Orbit Dynamics*, in “Physics of High Energy Accelerators,” edited by R.A. Carrigan, F.R. Hudson, and M. Month (AIP Conf. Proc. No. 87, New York, 1982), p. 147

A very extensive (~2400 pages) “new” (many years prep) book, A. Dragt, *Lie Methods for Nonlinear Dynamics with Applications to Accelerators*

is available free online: <http://www.physics.umd.edu/dsat/dsatliemethods.html>

References: continued (3)

Phase-amplitude methods, Larmor frame:

J.D. Lawson, *The Physics of Charged Particle Beams*, Oxford University Press (1977)

Solenoidal focusing and the Larmor frame:

H. Wiedemann, *Particle Accelerator Physics II: Nonlinear and Higher Order Beam Dynamics*, Springer (1995)

Extensive review articles with a similar perspective to the notes by S.M Lund and coauthors further clarifies material on phase advances, lattice focusing strength, etc.

S.M. Lund, T. Kikuchi, and R.C. Davidson, “Generation of initial kinetic distributions for simulation of long-pulse charged particle beams with high space-charge intensity,” *Phys. Rev. Special Topics – Accelerators and Beams* **12**, 114801 (2009)

S.M. Lund and B. Bukh, “Stability Properties of the Transverse Envelope Equations Describing Intense Ion Beam Transport,” *Phys. Rev. Special Topics – Accelerators and Beams* **7**, 024801 (2004)

Acknowledgments:

These lecture notes reflect input from numerous scientists and engineers who helped educate the author in accelerator physics over many years. Support enabling the long hours it took to produce these lecture notes were provided by the Facility for Rare Isotope Beams (FRIB) at Michigan State University (MSU), Lawrence Livermore National Laboratory (LLNL), and Lawrence Berkeley National Laboratory (LBNL). Special thanks are deserved to:

Rodger Bangerter	Martin Berz	John Barnard	
Oliver Boine-Frankenheim		Richard Briggs	Ronald Davidson
Mikhail Dorf	Andy Faltens	Bill Fawley	Giuliano Franchetti
Alex Friedman	Dave Grote	Irving Haber	Klaus Halbach
Enrique Henestroza	Ingo Hoffmann	Masnori Ikegami	Dave Judd
Igor Kagonovich	Takashi Kikuchi	Rami Kishek	Joe Kwan
Ed Lee	Daniela Leitner	Steve Lidia	Guillaume Machicoane
Felix Marti	Hiromi Okamoto	Eduard Pozdeyez	Martin Reiser
Lou Reginato	Robert Ryne	Gian-Luca Sabbi	Peter Seidl
William Sharp	Peter Spiller	Edward Startsev	Ken Takayama
Jean-Luc Vay	Will Waldron	Tom Wangler	Jie Wei
Yoshi Yamazaki	Simon Yu	Pavel Zenkovich	Yan Zhang
Qiang Zhao			

Acknowledgments Continued:

Specific input strongly influencing parts of these notes on **Transverse Particle Dynamics** include:

Klaus Halbach (LBNL): Use of complex variable theory to simplify analysis of multipole fields employed in **S3: Description of Applied Focusing Fields**.

Guliano Franchetti (GSI): phase amplitude methods employed.

Edward P. Lee (LBNL): Analysis techniques used for normalized variables in **S10: Acceleration and Normalized Emittance**.

Yingji Li (MSU), kindly donated time to improving these course notes in 2015.